

Обжимные фитинги серии 6D

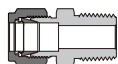

Содержание

Штуцер с наружной резьбой - CM



A-15

Штуцер с монтажной гайкой и наружной резьбой - BCM



A-26

Штуцер для установки термодпары - TCM

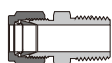

A-27

Хроматографический фитинг - U

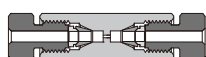

A-28

Хроматографический тройник - TTT

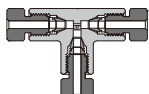

A-28

Фитинг с колонками на торцах - U

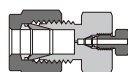

A-29

Штуцер с внутренней резьбой - CF

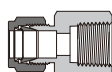

A-29

Штуцер с монтажной гайкой и внутренней резьбой - BCF

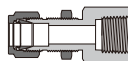

A-34

Муфта дюймовая - U



A-35

Муфта метрическая - U



A-36

Муфта переходная - U



A-37

Муфта с монтажной гайкой - BU



A-38

Муфта переходная с монтажной гайкой - BU

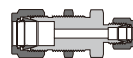

A-38

Муфта переходная с монтажной гайкой - BU



A-39

Гайка для крепления на панель - BN



A-39

Угольник ввертной 90° - LM

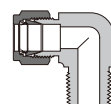

A-40

Угольник ввертной 45° - VM

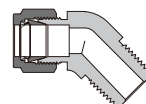

A-43

Угольник ввертной 90° с гайкой для позиционирования - LP

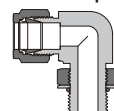

A-44

Угольник ввертной 45° с гайкой для позиционирования - VP



A-46

Угольник навертной 90° - LF

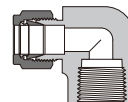

A-47

Угольник проходной 90° - LU

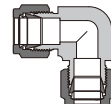

A-48

Угольник переходной 90° - LU

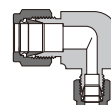

A-49

Угольник проходной 90° с монтажной гайкой - BBLU

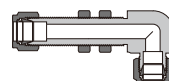

A-50

Содержание

Тройник симметричный ввертной - ТТМ

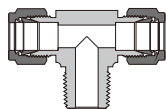

A-51

Тройник ввертной с боковым отводом - ТМТ

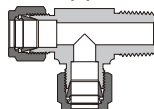

A-52

Тройник симметричный ввертной с гайкой для позиционирования - ТТР

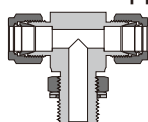

A-53

Тройник ввертной с боковым отводом с гайкой для позиционирования - ТРТ

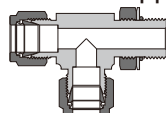

A-54

Тройник симметричный навертной - ТТФ

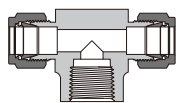

A-55

Тройник навертной с боковым отводом - ТФТ

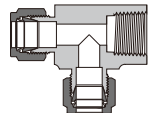

A-56

Тройник проходной - ТТТ

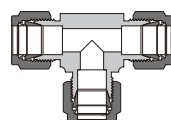

A-57

Тройник переходной - ТТТ

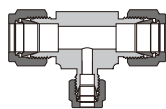

A-58

Крестовина проходная - С

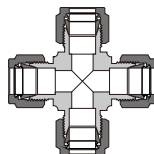

A-60

Колпак - ТС



A-60

Заглушка - ТР



A-61

Защитная заглушка для вентиляционных отверстий - VPF



A-61

Соединитель для монтажа свободных фланцев - LFC

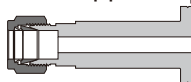

A-61

Гайка - N



A-62

Гайка с накаткой



A-62

Гайка с наружной резьбой - MN



A-62

Кольцо переднее обжимное - FF



A-63

Кольцо заднее обжимное - RF



A-63

Комплект - гайка, обжимные кольца - NFS



A-64

Комплекты обжимных колец - FRS













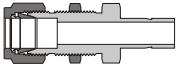
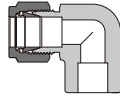
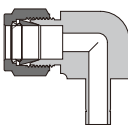
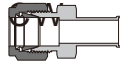
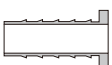

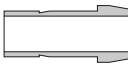
A-64

Переходник - R

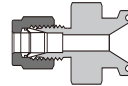

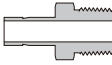
A-65

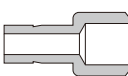
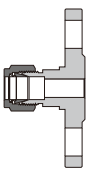
Содержание

Переходник с монтажной гайкой - BR		A-67	Угольник приварной 90° - LW		A-82
Угольник с переходником 90° - LR		A-67	Штуцер приварной для автоматической сварки -		A-83
Втулка для мягких пластиковых труб - IN		A-68	Фитинг калибровочный - FC		A-83
Соединитель для проходного канала - P		A-68	Фитинг с диэлектрической вставкой - DF		A-84
Переходник для проходного канала - P		A-69	Фитинг с прозрачной вставкой - SGF		A-85
Фитинг фланцевый санитарно-технический - SFF		A-69	Прокладка под фитинг - RS, RSD		A-86
Переходник с наружной резьбой - AM		A-70	Прокладка под фитинг - RP		A-86
Переходник с внутренней резьбой - AF		A-75	Прокладка под фитинг - RG		A-87
Переходник приварной встык - AW		A-78	Прокладка под фитинг - RJ		A-87
Фланцевый адаптер - FA		A-79	Кольцо уплотнительное - VI, BN		A-88
Штуцер приварной - CW		A-81	PTFE лента для уплотнения конических резьб - PTS		A-88
			Обозначение артикула		A-89

Характеристики

- Размеры варьируются от 1/16" до 2" и от 2 мм до 50 мм
- Имеются различные материалы и конфигурации
- Высокоточно изготовленные и обработанные компоненты способствуют надежному обжиму колец на трубе
- Упрочненная резьба с гладкой поверхностью предотвращает заедание резьбы и продлевает срок службы фитинга
- Внутренняя резьба гаек покрыта слоем серебра для уменьшения трения во время монтажа
- Закругленная конструкция угловых штуцеров обеспечивает плавный поток среды
- На каждый фитинг наносится размер, материал и номер плавки
- Фитинги легко разбираются и собираются заново
- Фитинги размерами от 1/8" до 5/8" (3 мм до 16 мм) доступны с сертификацией в соответствии с директивой ЕС-79



Технические данные

○ Торцевые резьбовые соединения

Резьба NPT (NPT)

- В соответствии с требованиями ASME B1.20.1, SAE AS71051.

Параметры резьбы						
Размер резьбы	Нитей на дюйм	Диам. резьбы в основной плоскости (мм)			Длина зацепления при затяжке вручную	
		Макс. диам.	Сред. диам.	Мин. диам.	(мм)	Нити
1/16	27	7.894	7.142	6.389	4.064	4.32
1/8		10.242	9.489	8.737	4.102	4.36
1/4	18	13.616	12.487	11.358	5.785	4.10
3/8		17.055	15.926	14.797	6.096	4.32
1/2	14	21.224	19.772	18.321	8.128	4.48
3/4		26.569	25.117	23.666	8.618	4.75
1	11.5	33.228	31.461	29.694	10.160	4.60
1 1/4		41.985	40.218	38.451	10.668	4.83
1 1/2		48.054	46.287	44.520	10.668	4.83
2		60.092	58.325	56.558	11.065	5.01

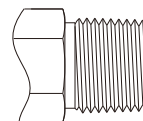

- Угол профиля резьбы 60°
- Шаг измеряется в дюймах
- Усечение впадины и вершины параллельно
- Конусность 1:16
- Тип уплотнения: резьбовой герметик

Рабочее давление для торцевых соединений с резьбой NPT								
Размер резьбы	Нержавеющая сталь 316 и углеродистая сталь				Латунь			
	Наружная		Внутренняя		Наружная		Внутренняя	
	фунт на кв. дюйм	бар	фунт на кв. дюйм	бар	фунт на кв. дюйм	бар	фунт на кв. дюйм	бар
1/16	11000	757	6700	460	5500	378	3300	227
1/8	10000	690	6500	447	5000	344	3200	220
1/4	8000	551	6600	454	4000	275	3300	227
3/8	7800	537	5300	365	3900	268	2600	179
1/2	7700	530	4900	337	3800	261	2400	165
3/4	7300	502	4600	316	3600	248	2300	158
1	5300	365	4400	303	2600	179	2200	151
1 1/4	6000	410	5000	344	3000	200	2500	172
1 1/2	5000	344	4600	317	2500	172	2300	158
2	3900	268	3900	268	1900	130	1900	130

Рабочее давление соответствует ANSI/ASME B31.3 при температуре окружающей среды.

Коническая резьба по ISO (R, R1, R2, RC, RT, PT, BSPT, ZG)

© В соответствии с требованиями ISO 7-1, EN 10226-1, BS 21, DIN 2999, JIS B0203.

Параметры резьбы						
Размер резьбы	Нитей на дюйм	Диам. резьбы в основной плоскости (мм)			Длина зацепления	
		Макс. диам.	Сред. диам.	Мин. диам.	(мм)	Нити
1/16	28	7.723	7.142	6.561	4.0	4.4
1/8		9.728	9.147	8.566	4.0	4.4
1/4	19	13.157	12.301	11.445	6.0	4.5
3/8		16.662	15.806	14.950	6.4	4.8
1/2	14	20.955	19.793	18.631	8.2	4.5
3/4		26.441	25.279	24.117	9.5	5.2
1	11	33.249	31.770	30.291	10.4	4.5
1 1/4		41.910	40.431	38.952	12.7	5.5
1 1/2		47.803	46.324	44.845	12.7	5.5
2		59.614	58.135	56.656	15.9	6.9

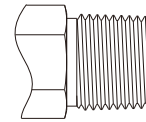

- Угол профиля резьбы 55°
- Шаг измеряется в дюймах
- Впадина и вершина резьбы - круглые
- Конусность 1:16
- Тип уплотнения: резьбовой герметик

Рабочее давление для торцевых соединений с конической резьбой ISO

Рабочее давление для торцевых соединений с конической резьбой ISO такое же, как для торцевых соединений резьбы NPT.

Цилиндрическая резьба по ISO (G, RP, PF, BSPP)

© В соответствии с требованиями ISO 228-1, DIN ISO 228-1, JIS B0202, BS 2779.

Данные о резьбе				
Размер резьбы	Нитей на дюйм	Основные диам. (мм)		
		Макс. диам.	Сред. диам.	Мин. диам.
1/16	28	7.723	7.142	6.561
1/8		9.728	9.147	8.566
1/4	19	13.157	12.301	11.445
3/8		16.662	15.806	14.950
1/2	14	20.955	19.793	18.631
5/8		22.911	21.749	20.587
3/4		26.441	25.279	24.117
7/8		30.201	29.039	27.877
1	11	33.249	31.770	30.291
1 1/8		37.897	36.418	34.939
1 1/4		41.910	40.431	38.952
1 1/2		47.803	46.324	44.845
1 3/4		53.746	52.267	50.788
2		59.614	58.135	56.656

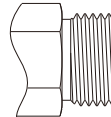

- Угол профиля резьбы 55°
- Шаг измеряется в дюймах
- Впадина и вершина резьбы - круглые

Типы уплотнения для цилиндрической резьбы ISO

1. Наружная резьба RS, прокладка RS и внутренняя резьба RP

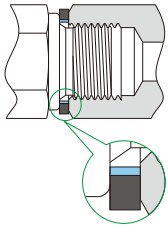

- Наружная резьба RS соответствует стандарту DIN 3852-2, тип A
- Для выбора прокладки RS см. страницу A-83
- Внутренняя резьбы RP соответствует стандарту DIN 3852, тип X

2. Наружная резьба RP, прокладка RP и внутренняя резьба RP

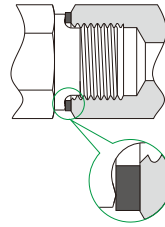

- Наружная резьба RP соответствует стандарту DIN 3852-2, тип B
- Для выбора прокладки RP см. страницу A-83
- Внутренняя резьба RP соответствует стандарту DIN 3852-2, тип X

3. Наружная резьба PP и внутренняя резьба RP

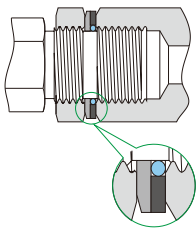

- Наружная резьба PP соответствует стандарту ISO 1179-3
- Внутренняя резьба RP соответствует стандарту DIN 3852-2, тип X

3. Внутренняя резьба RG, прокладка RG и наружная резьба BP

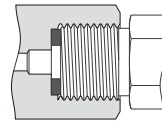

- Внутренняя резьба RG, соответствует стандарту EN 837-1/3
- Для выбора прокладки RG см. страницу A-84

Рабочее давление торцевых соединений с цилиндрической резьбой и гайкой для позиционирования ISO (PP)

Размер резьбы	Нержавеющая сталь 316 и углеродистая сталь	
	фунт на кв. дюйм	бар
1/8	4568	315
1/4		
3/8		
1/2	2320	160
3/4		
1		

Прямая резьба SAE/MS (UN, UNJ)

⊙ В соответствии с требованиями ASME B1.1, ISO R725.

Данные о резьбе

Размер резьбы	Нитей на дюйм	Основные диам. (мм)		
		Макс. диам.	Сред. диам.	Мин. диам.
5/16-24	24	7.938	7.249	6.792
3/8-24	24	9.525	8.837	8.380
7/16-20	20	11.113	10.287	9.738
1/2-20	20	12.700	11.875	11.326
9/16-18	18	14.288	13.325	12.761
3/4-16	16	19.050	18.019	17.330
7/8-14	14	22.225	21.046	20.262
1 1/16-12	12	26.988	25.613	24.719
1 3/16-12	12	30.163	28.788	27.871
1 5/16-12	12	33.338	31.963	31.046
1 5/8-12	12	41.275	39.901	38.984
1 7/8-12	12	47.625	46.251	45.324
2 1/2-12	12	63.500	62.126	61.209

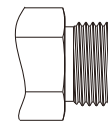

- Угол профиля резьбы 60°
- Шаг измеряется в дюймах
- Усечение впадины и вершины параллельно

Типы уплотнения для резьбы SAE/MS

1. Наружная резьба ST/SH и внутренняя резьба SAE J1926-1

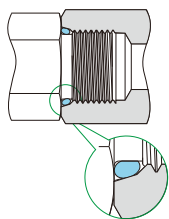

- Наружная резьба ST (легкая серия) соответствует требованиям SAE J1926-3
- Наружная резьба ST (тяжелая серия) соответствует требованиям SAE J1926-2
- Для выбора уплотнительного кольца см. страницу A-85

2. Наружная резьба под развальцовку 37° (AN) и трубка с развальцовкой

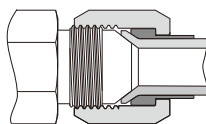

- Тип уплотнения соответствует требованиям SAE J514
- Давление в соответствии с каталогом по трубным фитингам под развальцовку 37°

G59#AG

" "	G59°	" "		" "		" "		" "	
		" "	" "	" "	" "	" "	" "	" "	" "
G	í ě í ě	í ě í	H €	í ě í	H €	Đ	Đ	Đ	Đ
H	H Đ ě					JFH	Ĥ Ĥ ě	Ĥ ě ě	I Ğ ě
I	Ĥ ě ě ě					JFH	Ĥ Ĥ ě	Ĥ ě ě	I Ğ ě
Ĥ	F ě ě ě					JFH	Ĥ Ĥ ě	Ĥ ě ě	I Ğ ě
Ĥ	J ě ě ě					JFH	Ĥ Ĥ ě	Ĥ ě ě	I Ğ ě
Ĥ	H Đ ě	I ě ě	H ě	I ě ě	G ě	JFH	Ĥ Ĥ ě	Ĥ ě ě	I Ğ ě
F ě	Ĥ Đ ě	H ě ě	G ě	H ě ě	G ě ě	JFH	Ĥ Ĥ ě	Ĥ ě ě	I Ğ ě
FG	F ě ě ě ě	H ě ě	G ě	H ě ě	G ě ě	Ĥ ě ě	I Ğ ě	Ĥ ě ě	I Ğ ě
FI	F ě ě ě ě	H ě ě	G ě ě	G ě ě	F ě ě	Ĥ ě ě	I Ğ ě	Ĥ ě ě	I Ğ ě
FĤ	F ě ě ě ě	H ě ě	G ě ě	G ě ě	F ě ě	Ĥ ě ě	I Ğ ě	I ě ě	H ě ě
Ğ ě	F ě ě ě ě	G ě ě	F ě ě	Ğ ě ě	F ě ě	I ě ě	G ě ě	I ě ě	G ě ě
G	F ě ě ě ě	Ğ ě ě	F ě ě	I ě ě	G ě ě	I ě ě	G ě ě	H ě ě	G ě ě
HG	G ě ě ě ě	Ğ ě ě	F ě ě	F ě ě ě	F ě ě	H ě ě	G ě ě	G ě ě	F ě ě

Метрическая резьба (M)

© В соответствии с требованиями ISO 261.

Данные о резьбе

Размер резьбы	Шаг (мм)	Основные диам. (мм)		
		Макс. диам.	Сред. диам.	Мин. диам.
M6 x 1	1	6.000	5.350	4.917
M8 x 1		8.000	7.350	6.917
M10 x 1		10.000	9.350	8.917
M12 x 1.5	1.5	12.000	11.026	10.376
M14 x 1.5		14.000	13.026	12.376
M16 x 1.5		16.000	15.026	14.376
M18 x 1.5		18.000	17.026	16.376
M20 x 1.5		20.000	19.026	18.376
M22 x 1.5		22.000	21.026	20.376
M24 x 1.5		24.000	23.026	22.376
M27 x 2	2	27.000	25.701	24.835
M30 x 2		30.000	28.701	27.835
M33 x 2		33.000	31.701	30.835
M36 x 2		36.000	34.701	33.835
M39 x 2		39.000	37.701	36.835
M42 x 2		42.000	40.701	39.835
M45 x 2		45.000	43.701	42.835
M48 x 2		48.000	46.701	45.835

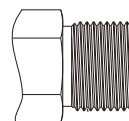

- Угол профиля резьбы 60°
- Шаг измеряется в мм
- Усечение впадины и вершины параллельно

Типы уплотнения для метрической резьбы

1. Наружная резьба MRS, прокладка RS-M и внутренняя резьба MS

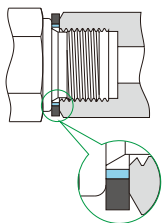

- Наружная резьба MRS соответствует стандарту DIN 3852-1 тип A
- Для выбора прокладки RS-M см. страницу A-83

2. Наружная резьба MS, прокладка RG-M и внутренняя резьба MS

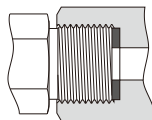

- Для выбора прокладки RG-M см. страницу A-84

3. Наружная резьба MST и внутренняя резьба ISO 6149-1

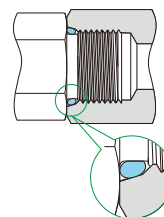

- Наружная резьба MST соответствует стандарту ISO 6149-3
- Для выбора уплотнительного кольца см. страницу A-85

Рабочие давления на торцевых соединениях резьбы MST

Размер резьбы	Нержавеющая сталь 316 и углеродистая сталь			
	Непозиционируемая		Позиционируемая	
	фунт на кв. дюйм	бар	фунт на кв. дюйм	бар
M8 x 1	5800	400	4568	315
M10 x 1				
M12 x 1.5				
M14 x 1.5				
M16 x 1.5	4568	315	3626	250
M18 x 1.5				
M20 x 1.5				
M22 x 1.5				
M27 x 2	2900	200	2320	160
M30 x 2				
M33 x 2				
M42 x 2				
M48 x 2				
M60 x 2	2320	160	1450	100

Рабочее давление соответствует ISO 6149-3 при температуре окружающей среды.

Торцы для приварки встык

Размеры и толщина стенок для торцов для приварки встык

Размер трубы		Наружный диаметр		Номинальная толщина стенки SCH80	
NPS	DN	дюйм	мм	дюйм	мм
1/8	6	0.405	10.3	0.095	2.41
1/4	8	0.540	13.7	0.119	3.02
3/8	10	0.675	17.1	0.126	3.20
1/2	15	0.840	21.3	0.147	3.73
3/4	20	1.050	26.7	0.154	3.91
1	25	1.315	33.4	0.179	4.55
1 1/4	32	1.660	42.2	0.191	4.85
1 1/2	40	1.900	48.3	0.200	5.08

Для получения приварных торцов других размеров и с другими толщинами стенок пожалуйста, свяжитесь с FITOK Group или с нашими авторизованными дистрибьюторами.

Рабочие температуры

Торцевые резьбовые соединения

Рабочая температура торцевых резьбовых соединений может быть ограничена применением тефлоновой ленты, резьбового герметика или, если применимо, прокладок или уплотнительных колец, согласно таблице ниже:

Компонент	Материал	Минимальная температура	Максимальная температура
Прокладка RS	Бутадиен-нитрильный каучук (Vulca N)	-25° C (-13° F)	110° C (230° F)
	Фтороуглерод FKM	-15° C (5° F)	204° C (400° F)
Прокладка RP/RG	Медь	-198° C (-325° F)	204° C (400° F)
	Нержавеющая сталь	-254° C (-425° F)	538° C (1000° F)
Прокладка RG	PTFE	-54° C (-65° F)	232° C (450° F)
	Вулканизированная фибра	-60° C (-76° F)	105° C (221° F)
Уплотн. кольцо	Бутадиен-нитрильный каучук (Vulca N)	-30° C (-22° F)	110° C (230° F)
	Фтороуглерод FKM	-20° C (-4° F)	204° C (400° F)

Рабочее давление

- Максимальное рабочее давление обжимных соединений при температуре окружающей среды определяются по максимальному рабочему давлению используемой трубки FITOK. См. раздел о трубках на F-02.
- Максимальные рабочие давления торцевых резьбовых соединений при температуре окружающей среды указаны выше.
- Для получения максимального рабочего давления при повышенной температуре используйте максимальное рабочее давление при температуре окружающей среды и умножьте его на коэффициенты, указанные в таблице "Коэффициенты для повышенных температур" на F-14.
- Максимальное рабочее давление всего фитинга определяется по торцевому соединению с наименьшим рабочим давлением.

Материалы

Материал	Прутковый прокат	Поковка	Обозначение
Нержавеющая сталь 316	ASTM A479, ASME SA479, EN 1.4401	ASTM A182, ASME SA182, EN 1.4401	SS
Нержавеющая сталь 316L	ASTM A479, ASME SA479, EN 1.4404	ASTM A182, ASME SA182, EN 1.4404	6L
Нержавеющая сталь 304	ASTM A479, ASME SA479, EN 1.4301	ASTM A182, ASME SA182, EN 1.4301	S4
Нержавеющая сталь 321	ASTM A479, ASME SA479, EN 1.4541	ASTM A182, ASME SA182, EN 1.4541	S1
Нержавеющая сталь 316Ti	ASTM A479, ASME SA479, EN 1.4571	ASTM A182, ASME SA182, EN 1.4571	6T
6Mo (S31254)	ASTM A479	ASTM A182	S12
Нержавеющая сталь 904L	ASTM A479	ASTM A182	904L
Титан (марка 4)	ASTM B348	ASTM B381	TI
Duplex 2205	ASTM A479	ASTM A182	D5
Super Duplex 2507	ASTM A479	ASTM A182	D7
Инколой 20	ASTM A479	ASTM B462	A20
Монель 400	ASTM B164, ASME SB164	ASTM B564, ASME SB564	M
Инконель 600	ASTM B166, ASME SB166	ASTM B564, ASME SB564	INC
Инконель 625	ASTM B446	ASTM B564, ASME SB564	A65
Инконель 718	ASTM B637	ASTM B637	A78
Инколой 825	ASTM B425	ASTM B564	A85
Hastelloy C-276	ASTM B574	ASTM B564	HC
Углеродистая сталь	ASTM A108	ASTM A105	CS
Латунь	ASTM B16/B453	ASTM B283	B
Нейлон	ASTM D4066	/	PA
PTFE	ASTM D1710	/	T

Примечание: Обычные материалы, выделенные жирным шрифтом, могут быть поставлены быстро; другие материалы изготавливаются на заказ, для уточнения срока выполнения заказа, пожалуйста, свяжитесь с FITOK Group или с нашими авторизованными дистрибьюторами.

Основа для номинального давления и спецификации резьбы

Тип резьбы (Торцевое соединение)	Основа для расчета давления	Тип резьбы	Справочная спецификация
Обжимной фитинг	Торцы трубных обжимных фитингов рассчитаны на рабочее давление трубок, как указано в разделе "Трубки"	Унифицированная дюймовая резьба	ASME B1.1
NPT	ASME B31.3, Технологические трубопроводы или испытание под давлением с расчетным коэффициентом 4:1, основанным на утечке гидравлической среды.	NPT	ASME B1.20.1, SAE AS71051
ISO/BSP (коническая)	ASME B31.3, Технологические трубопроводы или испытание под давлением с расчетным коэффициентом 4:1, основанным на утечке гидравлической среды.	ISO/BSP (коническая)	ISO 7, BS EN 10226-1, JIS B0203
ISO/BSP (цилиндрическая)	ISO 1179-3, ISO 228-1 «Торцы соединительных деталей с резьбой для легкого режима работы с кольцевым уплотнением и стопорным кольцом (типы G и H)» или испытание под давлением с расчетным коэффициентом 4:1 на основе утечки гидравлической среды.	ISO/BSP (цилиндрическая)	ISO 228, JIS B0202
ISO/BSP (цилиндрическая)	ISO 1179-4, ISO 228-1 «Торцы соединительных деталей с резьбой только общего назначения с уплотнением «металл-металл» (тип В)» или испытание под давлением с расчетным коэффициентом 4:1 на основе утечки гидравлической среды.	ISO/BSP (цилиндрическая)	ISO 228, JIS B0202
ISO/BSP (манометрическая) (На основе EN 837-1 и 837-3)	ASME B31.3, Технологические трубопроводы или испытание под давлением с расчетным коэффициентом 4:1, основанным на утечке гидравлической среды.	ISO/BSP (цилиндрическая)	ISO 228, JIS B0202
SAE-Легкая серия	SAE J1926/3 «Соединения общего назначения и для гидравлических систем — отверстия и торцы соединительных деталей с резьбой по ASME B1.1 и кольцевым уплотнением — часть 3: торцы соединительных деталей для легкого режима работы (серия L)» или испытание под давлением с расчетным коэффициентом 4:1 на основе утечки гидравлической среды.	Унифицированная дюймовая резьба	ASME B1.1
SAE-Тяжелая серия	SAE J1926/2 «Соединения общего назначения и для гидравлических систем — отверстия и торцы соединительных деталей с резьбой по ASME B1.1 и кольцевым уплотнением — часть 2: торцы соединительных деталей для тяжелого режима работы (серия S)» или испытание под давлением с расчетным коэффициентом 4:1 на основе утечки гидравлической среды.	Унифицированная дюймовая резьба	ASME B1.1
Фитинги AN	SAE J514 «Гидравлические трубные обжимные фитинги» или испытание под давлением с расчетным коэффициентом 4:1 на основе утечки гидравлической среды.	Унифицированная дюймовая резьба	ASME B1.1 UNJ, SAE AS 8879

Инструкции по монтажу

Обжимные фитинги FITOK до 1" или до 25 мм

● Ручной монтаж

Первоначальный монтаж

1. Открутите гайку на 1/4 оборота из положения ручной затяжки.
2. Вставьте трубу в обжимной фитинг, убедитесь, что трубка надежно опирается в буртик.
3. Затяните гайку вручную.
4. Затяните гайку на 1 1/4 оборота с помощью гаечного ключа, закрепив корпус фитинга или клапана в устойчивом положении (рис. 1).
Для малых трубных обжимных фитингов диаметром 1/16, 1/8 и 3/16 дюйма, 2, 3 и 4 мм гайку следует затянуть на 3/4 оборота гаечным ключом (см. рис. 2).

Повторный монтаж

1. Поставьте отметку на трубке у основания гайки, проведите линию вдоль гайки и плоских участков корпуса фитинга.
2. Вставьте трубку с предварительно установленными обжимными кольцами в корпус фитинга так, чтобы переднее обжимное кольцо было плотно зафиксировано.
3. Затем поверните гайку с помощью гаечного ключа в предыдущее затянутое положение, указанное отметками на трубке и плоских участках.
4. Слегка затяните гайку с помощью гаечного ключа.

● Монтаж с помощью инструмента предварительного обжима

Первоначальный монтаж

1. Держите инструмент для предварительного обжима ровно.
2. Установите гайку и обжимные кольца в инструмент предварительного обжима.
3. Затяните гайку вручную.
4. Затяните гайку по часовой стрелке на 1 1/4 оборота с помощью ключа (рис. 1);
Для фитингов малого размера (1/16", 1/8" и 3/16", 2 мм, 3 мм и 4 мм) затяните гайку на 3/4 оборота с помощью ключа (рис. 2).
5. Перед разборкой фитинга пометьте трубку в месте выхода трубки из гайки.
6. Открутите гайку и вставьте трубку с предварительно обжатými кольцами в корпус фитинга, пока переднее кольцо не прижмется к корпусу фитинга.
7. Удерживая корпус фитинга, поверните гайку с помощью гаечного ключа в положение предыдущей затяжки, указанное меткой на трубке.
8. Когда вы почувствуете значительное увеличение сопротивления, еще немного затяните гайку.

Повторный монтаж

Так же как и повторный монтаж при ручном монтаже фитингов до 1" или до 25 мм

● Монтаж с помощью гидравлического инструмента предварительного обжима

Первоначальный монтаж

1. Предварительно установите обжимные кольца на трубку с помощью гидравлического инструмента для предварительного обжима FITOK. Подробности см. в инструкции к гидравлическому инструменту для предварительного обжима.
2. Установите узел с предварительно обжатыми кольцами (трубка, гайка, переднее и заднее кольца) в корпус фитинга. Затяните гайку вручную.
3. Далее затяните гайку на 1/2 оборота с помощью гаечного ключа, удерживая корпус фитинга в неподвижном состоянии.

Повторный монтаж

Так же как и повторный монтаж при ручном монтаже фитингов до 1" или до 25 мм



Рис. 1



Рис. 2

Обжимные фитинги FITOK свыше 1" или 25 мм

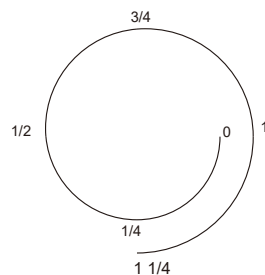
Первоначальный монтаж

1. Предварительно установите обжимные кольца на трубку с помощью гидравлического инструмента для предварительного обжима FITOK. Подробности см. в инструкции к гидравлическому инструменту для предварительного обжима.
2. Установите узел с предварительно обжатыми кольцами (трубка, гайка, переднее и заднее кольца) в корпус фитинга. Затяните гайку вручную.
3. Далее затяните гайку на 1/2 оборота с помощью гаечного ключа, удерживая корпус фитинга в неподвижном состоянии.

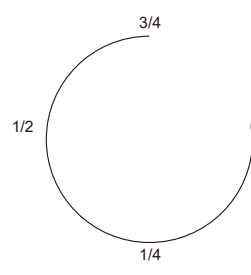
Повторный монтаж

Так же как и повторный монтаж при ручном монтаже фитингов до 1" или до 25 мм

Заглушки

Первоначальный монтаж

Затяните гайку на 1/4 оборота от положения затяжки вручную с помощью гаечного ключа, удерживая корпус фитинга в неподвижном состоянии. Для фитингов малого размера (1/16", 1/8" и 3/16", 2 мм, 3 мм и 4 мм) затяните гайку на 1/8 оборота с помощью гаечного ключа.

Повторный монтаж

Слегка затяните заглушку ключом, начиная с положения затяжки вручную.

Соединитель для проходного канала

Первоначальная установка и повторная установка соединителя для проходного канала такая же, как у трубных обжимных фитингов для торца с прямым патрубком, и такая же, как у заглушек для торца с имитацией колец.

Предупреждения:

- Не ослабляйте и не затягивайте фитинги, если система находится под давлением.
- Убедитесь, что трубка надежно упирается в буртик.
- Всегда оставляйте достаточно прямого участка трубки для фитингов.
- Всегда используйте вставку для мягких пластиковых труб.
- Материал металлической трубки должен быть мягче, чем материал фитинга. Например, трубки из нержавеющей стали не должны использоваться вместе с латунными фитингами. Если трубки и фитинги изготовлены из одинакового материала, трубки должны быть полностью отождены.
- Допустимое рабочее давление трубного фитинга рассчитывается по максимальному рабочему давлению соответствующей трубки, которое можно найти в техническом паспорте на трубки FITOK. Если оно не указано в техническом паспорте на трубки FITOK, свяжитесь с FITOK Group или с нашими официальными дистрибьюторами для получения информации.
- Следите за тем, чтобы торцы и поверхность трубок были чистыми и гладкими.
- Всегда используйте подходящие резьбовые герметики на конической трубной резьбе. Убедитесь, что ее рабочая температура не превышает рабочей температуры герметиков.
- При сборке обжимного фитинга закрепите корпус с помощью гаечного ключа и поверните (а не закрепляйте) гайку.
- При установке клапана с торцевым обжимным фитингом закрепите корпус клапана с помощью гаечного ключа и поверните гайку.
- При сборке фитинга и клапана с резьбой закрепите корпус клапана с помощью гаечного ключа и поверните корпус фитинга.
- Щуп для контроля зазора применяется ТОЛЬКО при первоначальном ручном монтаже.

Размеры

1. Размеры указаны только для справки и могут быть изменены. Размеры показаны в положении, когда гайки FITOK затянуты вручную.
2. Размер E обозначает наименьшее номинальное отверстие. Он может быть больше на торцевых соединениях с конической резьбой, торцевых соединениях с прямой резьбой и приварных торцевых соединениях.

Штуцер с наружной резьбой

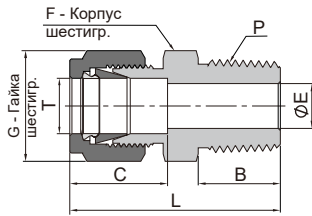

Дюймовая трубка			Резьба NPT					
D нар. трубки T (дюймы)	Размер P-NPT	Артикул	Размеры, мм (дюймы)					
			L	B	C	E	G	F
1/16	1/16	-CM-FL1-NS1	23.9 (0.94)	9.7 (0.38)	8.6 (0.34)	1.3 (0.05)	7.9 (0.31)	7.9 (0.31)
1/16	1/8	-CM-FL1-NS2	26.2 (1.03)	9.7 (0.38)	8.6 (0.34)	1.3 (0.05)	7.9 (0.31)	11.1 (0.44)
1/16	1/4	-CM-FL1-NS4	31.0 (1.22)	14.2 (0.56)	8.6 (0.34)	1.3 (0.05)	7.9 (0.31)	14.3 (0.56)
1/8	1/16	-CM-FL2-NS1	29.7 (1.17)	9.7 (0.38)	12.7 (0.50)	2.3 (0.09)	11.1 (0.44)	11.1 (0.44)
1/8	1/8	-CM-FL2-NS2	30.5 (1.20)	9.7 (0.38)	12.7 (0.50)	2.3 (0.09)	11.1 (0.44)	11.1 (0.44)
1/8	1/4	-CM-FL2-NS4	35.6 (1.40)	14.2 (0.56)	12.7 (0.50)	2.3 (0.09)	11.1 (0.44)	14.3 (0.56)
1/8	3/8	-CM-FL2-NS6	35.8 (1.41)	14.2 (0.56)	12.7 (0.50)	2.3 (0.09)	11.1 (0.44)	17.5 (0.69)
1/8	1/2	-CM-FL2-NS8	42.2 (1.66)	19.1 (0.75)	12.7 (0.50)	2.3 (0.09)	11.1 (0.44)	22.2 (0.87)
3/16	1/16	-CM-FL3-NS1	31.2 (1.23)	9.7 (0.38)	13.7 (0.54)	3.0 (0.12)	12.7 (0.50)	11.1 (0.44)
3/16	1/8	-CM-FL3-NS2	31.2 (1.23)	9.7 (0.38)	13.7 (0.54)	3.0 (0.12)	12.7 (0.50)	11.1 (0.44)
3/16	1/4	-CM-FL3-NS4	36.3 (1.43)	14.2 (0.56)	13.7 (0.54)	3.0 (0.12)	12.7 (0.50)	14.3 (0.56)
1/4	1/16	-CM-FL4-NS1	32.8 (1.29)	9.7 (0.38)	15.2 (0.60)	3.0 (0.12)	14.3 (0.56)	12.7 (0.50)
1/4	1/8	-CM-FL4-NS2	32.8 (1.29)	9.7 (0.38)	15.2 (0.60)	4.8 (0.19)	14.3 (0.56)	12.7 (0.50)
1/4	1/4	-CM-FL4-NS4	37.8 (1.49)	14.2 (0.56)	15.2 (0.60)	4.8 (0.19)	14.3 (0.56)	14.3 (0.56)
1/4	3/8	-CM-FL4-NS6	38.4 (1.51)	14.2 (0.56)	15.2 (0.60)	4.8 (0.19)	14.3 (0.56)	17.5 (0.69)
1/4	1/2	-CM-FL4-NS8	44.7 (1.76)	19.1 (0.75)	15.2 (0.60)	4.8 (0.19)	14.3 (0.56)	22.2 (0.87)
1/4	3/4	-CM-FL4-NS12	46.2 (1.82)	19.1 (0.75)	15.2 (0.60)	4.8 (0.19)	14.3 (0.56)	27.0 (1.06)
5/16	1/8	-CM-FL5-NS2	34.0 (1.34)	9.7 (0.38)	16.3 (0.64)	4.8 (0.19)	15.9 (0.63)	14.3 (0.56)
5/16	1/4	-CM-FL5-NS4	38.6 (1.52)	9.7 (0.38)	16.3 (0.64)	6.4 (0.25)	15.9 (0.63)	14.3 (0.56)
5/16	3/8	-CM-FL5-NS6	39.1 (1.54)	14.2 (0.56)	16.3 (0.64)	6.4 (0.25)	15.9 (0.63)	17.5 (0.69)
5/16	1/2	-CM-FL5-NS8	45.5 (1.79)	19.1 (0.75)	16.3 (0.64)	6.4 (0.25)	15.9 (0.63)	22.2 (0.87)
3/8	1/8	-CM-FL6-NS2	35.3 (1.39)	9.7 (0.38)	16.8 (0.66)	4.8 (0.19)	17.5 (0.69)	15.9 (0.63)
3/8	1/4	-CM-FL6-NS4	39.9 (1.57)	14.2 (0.56)	16.8 (0.66)	7.1 (0.28)	17.5 (0.69)	15.9 (0.63)
3/8	3/8	-CM-FL6-NS6	39.9 (1.57)	14.2 (0.56)	16.8 (0.66)	7.1 (0.28)	17.5 (0.69)	17.5 (0.69)
3/8	1/2	-CM-FL6-NS8	46.2 (1.82)	19.1 (0.75)	16.8 (0.66)	7.1 (0.28)	17.5 (0.69)	22.2 (0.87)
3/8	3/4	-CM-FL6-NS12	47.8 (1.88)	19.1 (0.75)	16.8 (0.66)	7.1 (0.28)	17.5 (0.69)	27.0 (1.06)
3/8	1	-CM-FL6-NS16	54.4 (2.14)	23.9 (0.94)	16.8 (0.66)	7.1 (0.28)	17.5 (0.69)	34.9 (1.37)
1/2	1/8	-CM-FL8-NS2	38.9 (1.53)	9.7 (0.38)	22.9 (0.90)	4.8 (0.19)	22.2 (0.87)	20.6 (0.81)
1/2	1/4	-CM-FL8-NS4	43.4 (1.71)	14.2 (0.56)	22.9 (0.90)	7.1 (0.28)	22.2 (0.87)	20.6 (0.81)
1/2	3/8	-CM-FL8-NS6	43.4 (1.71)	14.2 (0.56)	22.9 (0.90)	9.7 (0.38)	22.2 (0.87)	20.6 (0.81)
1/2	1/2	-CM-FL8-NS8	49.0 (1.93)	19.1 (0.75)	22.9 (0.90)	10.4 (0.41)	22.2 (0.87)	22.2 (0.87)
1/2	3/4	-CM-FL8-NS12	50.5 (1.99)	19.1 (0.75)	22.9 (0.90)	10.4 (0.41)	22.2 (0.87)	27.0 (1.06)
1/2	1	-CM-FL8-NS16	57.2 (2.25)	23.9 (0.94)	22.9 (0.90)	10.4 (0.41)	22.2 (0.87)	34.9 (1.37)
5/8	1/4	-CM-FL10-NS4	44.2 (1.74)	14.2 (0.56)	24.4 (0.96)	7.1 (0.28)	25.4 (1.00)	23.8 (0.94)
5/8	3/8	-CM-FL10-NS6	44.2 (1.74)	14.2 (0.56)	24.4 (0.96)	9.7 (0.38)	25.4 (1.00)	23.8 (0.94)
5/8	1/2	-CM-FL10-NS8	49.0 (1.93)	19.1 (0.75)	24.4 (0.96)	11.9 (0.47)	25.4 (1.00)	23.8 (0.94)
5/8	3/4	-CM-FL10-NS12	50.5 (1.99)	19.1 (0.75)	24.4 (0.96)	12.7 (0.50)	25.4 (1.00)	27.0 (1.06)
3/4	3/8	-CM-FL12-NS6	45.7 (1.80)	14.2 (0.56)	24.4 (0.96)	10.4 (0.41)	28.6 (1.13)	27.0 (1.06)
3/4	1/2	-CM-FL12-NS8	50.5 (1.99)	19.1 (0.75)	24.4 (0.96)	11.9 (0.47)	28.6 (1.13)	27.0 (1.06)
3/4	3/4	-CM-FL12-NS12	50.5 (1.99)	19.1 (0.75)	24.4 (0.96)	15.7 (0.62)	28.6 (1.13)	27.0 (1.06)
3/4	1	-CM-FL12-NS16	57.2 (2.25)	23.9 (0.94)	24.4 (0.96)	15.7 (0.62)	28.6 (1.13)	34.9 (1.37)
7/8	1/2	-CM-FL14-NS8	50.5 (1.99)	19.1 (0.75)	25.9 (1.02)	11.9 (0.47)	31.8 (1.25)	30.2 (1.19)
7/8	3/4	-CM-FL14-NS12	50.5 (1.99)	19.1 (0.75)	25.9 (1.02)	15.7 (0.62)	31.8 (1.25)	30.2 (1.19)
7/8	1	-CM-FL14-NS16	57.2 (2.25)	23.9 (0.94)	25.9 (1.02)	18.3 (0.72)	31.8 (1.25)	34.9 (1.37)
1	1/2	-CM-FL16-NS8	57.4 (2.26)	19.1 (0.75)	31.2 (1.23)	11.9 (0.47)	38.1 (1.50)	34.9 (1.37)
1	3/4	-CM-FL16-NS12	57.4 (2.26)	19.1 (0.75)	31.2 (1.23)	15.7 (0.62)	38.1 (1.50)	34.9 (1.37)
1	1	-CM-FL16-NS16	62.2 (2.45)	23.9 (0.94)	31.2 (1.23)	22.4 (0.88)	38.1 (1.50)	34.9 (1.37)
1 1/8	1	-CM-FL18-NS16	62.2 (2.45)	23.9 (0.94)	36.7 (1.44)	22.4 (0.88)	44.5 (1.75)	41.3 (1.63)
1 1/4	1	-CM-FL20-NS16	77.2 (3.04)	23.9 (0.94)	41.1 (1.62)	22.4 (0.88)	47.6 (1.87)	44.5 (1.75)
1 1/4	1 1/4	-CM-FL20-NS20	77.2 (3.04)	23.9 (0.94)	41.1 (1.62)	27.7 (1.09)	47.6 (1.87)	44.5 (1.75)
1 1/2	1 1/2	-CM-FL24-NS24	88.9 (3.50)	26.2 (1.03)	50.0 (1.97)	34.0 (1.34)	57.2 (2.25)	54.0 (2.13)

Штуцер с наружной резьбой

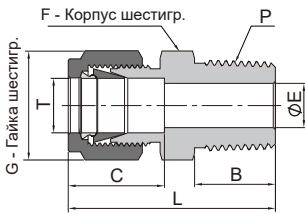

Дюймовая трубка			Коническая резьба ISO (RT)						
D нар. трубки T (дюймы)	Размер P-RT	Артикул	Размеры, мм (дюймы)						
			L	B	C	E	G	F	
1/8	1/8	-CM-FL2-RT2	30.5(1.20)	9.7(0.38)	12.7(0.50)	2.3(0.09)	11.1(0.44)	11.1(0.44)	
1/8	1/4	-CM-FL2-RT4	35.6(1.40)	14.2(0.56)	12.7(0.50)	2.3(0.09)	11.1(0.44)	14.3(0.56)	
1/4	1/8	-CM-FL4-RT2	32.8(1.29)	9.7(0.38)	15.2(0.60)	4.8(0.19)	14.3(0.56)	12.7(0.50)	
1/4	1/4	-CM-FL4-RT4	37.8(1.49)	14.2(0.56)	15.2(0.60)	4.8(0.19)	14.3(0.56)	14.3(0.56)	
1/4	3/8	-CM-FL4-RT6	38.4(1.51)	14.2(0.56)	15.2(0.60)	4.8(0.19)	14.3(0.56)	17.5(0.69)	
1/4	1/2	-CM-FL4-RT8	44.7(1.76)	19.1(0.75)	15.2(0.60)	4.8(0.19)	14.3(0.56)	22.2(0.87)	
5/16	1/8	-CM-FL5-RT2	34.0(1.34)	9.7(0.38)	16.3(0.64)	4.8(0.19)	15.9(0.63)	14.3(0.56)	
5/16	1/4	-CM-FL5-RT4	38.6(1.52)	14.2(0.56)	16.3(0.64)	6.4(0.25)	15.9(0.63)	14.3(0.56)	
3/8	1/8	-CM-FL6-RT2	35.3(1.39)	9.7(0.38)	16.8(0.66)	4.8(0.19)	17.5(0.69)	15.9(0.63)	
3/8	1/4	-CM-FL6-RT4	39.9(1.57)	14.2(0.56)	16.8(0.66)	7.1(0.28)	17.5(0.69)	15.9(0.63)	
3/8	3/8	-CM-FL6-RT6	39.9(1.57)	14.2(0.56)	16.8(0.66)	7.1(0.28)	17.5(0.69)	17.5(0.69)	
3/8	1/2	-CM-FL6-RT8	46.2(1.82)	19.1(0.75)	16.8(0.66)	7.1(0.28)	17.5(0.69)	22.2(0.87)	
3/8	3/4	-CM-FL6-RT12	47.8(1.88)	19.1(0.75)	16.8(0.66)	7.1(0.28)	17.5(0.69)	27.0(1.06)	
1/2	1/4	-CM-FL8-RT4	43.4(1.71)	14.2(0.56)	22.9(0.90)	7.1(0.28)	22.2(0.87)	20.6(0.81)	
1/2	3/8	-CM-FL8-RT6	43.4(1.71)	14.2(0.56)	22.9(0.90)	9.7(0.38)	22.2(0.87)	20.6(0.81)	
1/2	1/2	-CM-FL8-RT8	49.0(1.93)	19.1(0.75)	22.9(0.90)	10.4(0.41)	22.2(0.87)	22.2(0.87)	
1/2	3/4	-CM-FL8-RT12	50.5(1.99)	19.1(0.75)	22.9(0.90)	10.4(0.41)	22.2(0.87)	27.0(1.06)	
5/8	1/2	-CM-FL10-RT8	49.0(1.93)	19.1(0.75)	24.4(0.96)	11.9(0.47)	25.4(1.00)	23.8(0.94)	
3/4	3/4	-CM-FL12-RT12	50.5(1.99)	19.1(0.75)	24.4(0.96)	15.7(0.62)	28.6(1.13)	27.0(1.06)	
3/4	1	-CM-FL12-RT16	57.2(2.25)	23.9(0.94)	24.4(0.96)	15.7(0.62)	28.6(1.13)	34.9(1.37)	
1	3/4	-CM-FL16-RT12	57.4(2.26)	19.1(0.75)	31.2(1.23)	15.7(0.62)	38.1(1.50)	34.9(1.37)	
1	1	-CM-FL16-RT16	62.2(2.45)	23.9(0.94)	31.2(1.23)	22.4(0.88)	38.1(1.50)	34.9(1.37)	

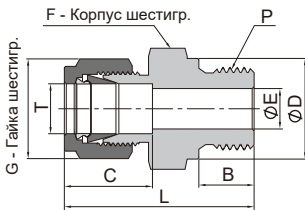

Дюймовая трубка			Цилиндрическая резьба ISO (RS)						
D нар. трубки T (дюймы)	Размер P-RS	Артикул	Размеры, мм (дюймы)						
			L	B	C	E	G	F	D
1/8	1/8	-CM-FL2-RS2	30.0(1.18)	7.1(0.28)	12.7(0.50)	2.3(0.09)	11.1(0.44)	14.3(0.56)	13.7(0.54)
1/8	1/4	-CM-FL2-RS4	35.3(1.39)	11.2(0.44)	12.7(0.50)	2.3(0.09)	11.1(0.44)	19.1(0.75)	18.0(0.71)
1/8	3/8	-CM-FL2-RS6	36.3(1.43)	11.2(0.44)	12.7(0.50)	2.3(0.09)	11.1(0.44)	22.2(0.87)	21.8(0.86)
1/4	1/8	-CM-FL4-RS2	32.3(1.27)	7.1(0.28)	15.2(0.60)	4.0(0.16)	14.3(0.56)	14.3(0.56)	13.7(0.54)
1/4	1/4	-CM-FL4-RS4	37.6(1.48)	11.2(0.44)	15.2(0.60)	4.8(0.19)	14.3(0.56)	19.1(0.75)	18.0(0.71)
1/4	3/8	-CM-FL4-RS6	38.9(1.53)	11.2(0.44)	15.2(0.60)	4.8(0.19)	14.3(0.56)	22.2(0.87)	21.8(0.86)
1/4	1/2	-CM-FL4-RS8	44.7(1.76)	14.2(0.56)	15.2(0.60)	4.8(0.19)	14.3(0.56)	27.0(1.06)	25.9(1.02)
3/8	1/8	-CM-FL6-RS2	37.8(1.49)	7.1(0.28)	16.8(0.66)	4.0(0.16)	17.5(0.69)	15.9(0.63)	13.7(0.54)
3/8	1/4	-CM-FL6-RS4	39.1(1.54)	11.2(0.44)	16.8(0.66)	5.9(0.23)	17.5(0.69)	19.1(0.75)	18.0(0.71)
3/8	3/8	-CM-FL6-RS6	40.4(1.59)	11.2(0.44)	16.8(0.66)	7.1(0.28)	17.5(0.69)	22.2(0.87)	21.8(0.86)
3/8	1/2	-CM-FL6-RS8	46.2(1.82)	14.2(0.56)	16.8(0.66)	7.1(0.28)	17.5(0.69)	27.0(1.06)	25.9(1.02)
1/2	1/4	-CM-FL8-RS4	42.7(1.68)	11.2(0.44)	22.9(0.90)	5.9(0.23)	22.2(0.87)	20.6(0.81)	18.0(0.71)
1/2	3/8	-CM-FL8-RS6	43.2(1.70)	11.2(0.44)	22.9(0.90)	7.9(0.31)	22.2(0.87)	22.2(0.87)	21.8(0.86)
1/2	1/2	-CM-FL8-RS8	49.0(1.93)	14.2(0.56)	22.9(0.90)	10.4(0.41)	22.2(0.87)	27.0(1.06)	25.9(1.02)
3/4	1/2	-CM-FL12-RS8	49.0(1.93)	14.2(0.56)	24.4(0.96)	11.9(0.47)	28.6(1.13)	27.0(1.06)	25.9(1.02)
3/4	3/4	-CM-FL12-RS12	52.9(2.08)	15.7(0.62)	24.4(0.96)	15.7(0.62)	28.6(1.13)	33.3(1.31)	32.0(1.26)
1	1/2	-CM-FL16-RS8	55.5(2.19)	14.2(0.56)	31.2(1.23)	11.9(0.47)	38.1(1.50)	34.9(1.37)	25.9(1.02)
1	3/4	-CM-FL16-RS12	57.7(2.27)	15.7(0.62)	31.2(1.23)	16.0(0.63)	38.1(1.50)	34.9(1.37)	32.0(1.26)
1	1	-CM-FL16-RS16	59.9(2.36)	18.3(0.72)	31.2(1.23)	19.8(0.78)	38.1(1.50)	41.3(1.63)	39.1(1.54)

Штуцер с наружной резьбой

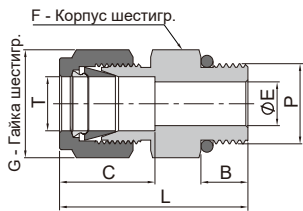
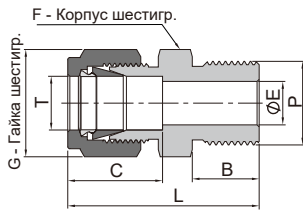
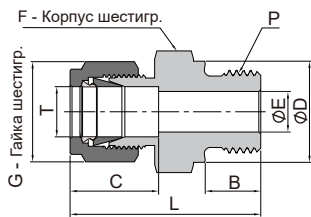

Совместим с прямой внутренней резьбой SAE J1926-1, ISO 11926-1 и MS 16142.

Дюймовая трубка			Цилиндрическая резьба ISO (RP)						
D нар. трубки T (дюймы)	Размер P-RP	Артикул	Размеры, мм (дюймы)						
			L	B	C	E	G	F	D
1/8	1/8	-CM-FL2-RP2	30.0(1.18)	7.1(0.28)	12.7(0.50)	2.3(0.09)	11.1(0.44)	14.3(0.56)	13.8(0.54)
1/8	1/4	-CM-FL2-RP4	35.3(1.39)	11.2(0.44)	12.7(0.50)	2.3(0.09)	11.1(0.44)	19.1(0.75)	17.8(0.70)
1/4	1/8	-CM-FL4-RP2	32.3(1.27)	7.1(0.28)	15.2(0.60)	4.1(0.16)	14.3(0.56)	14.3(0.56)	13.8(0.54)
1/4	1/4	-CM-FL4-RP4	37.6(1.48)	11.2(0.44)	15.2(0.60)	4.8(0.19)	14.3(0.56)	19.1(0.75)	17.8(0.70)
1/2	3/8	-CM-FL8-RP6	45.5(1.79)	11.2(0.44)	22.9(0.90)	7.9(0.31)	22.2(0.87)	22.2(0.87)	21.8(0.86)
1/2	1/2	-CM-FL8-RP8	49.0(1.93)	14.2(0.56)	22.9(0.90)	10.4(0.41)	22.2(0.87)	27.0(1.06)	25.9(1.02)
3/4	1/2	-CM-FL12-RP8	49.0(1.93)	14.2(0.56)	24.4(0.96)	11.9(0.47)	28.6(1.13)	27.0(1.06)	25.9(1.02)
3/4	3/4	-CM-FL12-RP12	52.9(2.08)	15.7(0.62)	24.4(0.96)	15.7(0.62)	28.6(1.13)	33.3(1.31)	32.0(1.26)
1	1	-CM-FL16-RP16	59.9(2.36)	18.3(0.72)	31.2(1.23)	19.8(0.78)	38.1(1.50)	41.3(1.63)	38.8(1.53)

Дюймовая трубка			Цилиндрическая резьба ISO (RP)					
D нар. трубки T (дюймы)	Размер P-RP	Артикул	Размеры, мм (дюймы)					
			L	B	C	E	G	F
1/4	3/8	-CM-FL4-BP6	38.4(1.51)	14.2(0.56)	15.2(0.60)	4.8(0.19)	14.3(0.56)	17.5(0.69)
3/8	3/8	-CM-FL6-BP6	39.9(1.57)	14.2(0.56)	16.8(0.66)	7.1(0.28)	17.5(0.69)	17.5(0.69)

Дюймовая трубка			Прямая резьба SAE/MS (ST)					
D нар. трубки T (дюймы)	Размер резьбы P-SAE/MS	Артикул	Размеры, мм (дюймы)					
			L	B	C	E	G	F
1/16	5/16-24	-CM-FL1-ST5	23.4(0.92)	7.6(0.30)	0.34(8.6)	1.3(0.05)	7.9(0.31)	11.1(0.44)
1/8	5/16-24	-CM-FL2-ST5	30.0(1.18)	7.6(0.30)	12.7(0.50)	2.3(0.09)	11.1(0.44)	11.1(0.44)
1/8	7/16-20	-CM-FL2-ST7	31.5(1.24)	9.1(0.36)	12.7(0.50)	2.3(0.09)	11.1(0.44)	14.3(0.56)
1/8	9/16-18	-CM-FL2-ST9	33.3(1.31)	9.9(0.39)	12.7(0.50)	2.3(0.09)	11.1(0.44)	17.5(0.69)
3/16	3/8-24	-CM-FL3-ST6	30.5(1.20)	7.6(0.30)	13.7(0.54)	3.0(0.12)	12.7(0.50)	12.7(0.50)
1/4	5/16-24	-CM-FL4-ST5	32.3(1.27)	7.6(0.30)	15.2(0.60)	3.0(0.12)	14.3(0.56)	12.7(0.50)
1/4	7/16-20	-CM-FL4-ST7	34.0(1.34)	9.1(0.36)	15.2(0.60)	4.8(0.19)	14.3(0.56)	14.3(0.56)
1/4	9/16-18	-CM-FL4-ST9	35.6(1.40)	9.9(0.39)	15.2(0.60)	4.8(0.19)	14.3(0.56)	17.5(0.69)
1/4	3/4-16	-CM-FL4-ST12	37.6(1.48)	11.2(0.44)	15.2(0.60)	4.8(0.19)	14.3(0.56)	22.2(0.87)
1/4	7/8-14	-CM-FL4-ST14	40.6(1.60)	12.7(0.50)	15.2(0.60)	4.8(0.19)	14.3(0.56)	25.4(1.00)
5/16	1/2-20	-CM-FL5-ST8	34.8(1.37)	9.1(0.36)	16.3(0.64)	6.4(0.25)	15.9(0.63)	15.9(0.63)
3/8	7/16-20	-CM-FL6-ST7	35.6(1.40)	9.1(0.36)	16.8(0.66)	5.1(0.20)	17.5(0.69)	15.9(0.63)
3/8	9/16-18	-CM-FL6-ST9	37.1(1.46)	9.9(0.39)	16.8(0.66)	7.1(0.28)	17.5(0.69)	17.5(0.69)
3/8	3/4-16	-CM-FL6-ST12	39.1(1.54)	11.2(0.44)	16.8(0.66)	7.1(0.28)	17.5(0.69)	22.2(0.87)
3/8	7/8-14	-CM-FL6-ST14	42.2(1.66)	12.7(0.50)	16.8(0.66)	7.1(0.28)	17.5(0.69)	25.4(1.00)
1/2	9/16-18	-CM-FL8-ST9	39.1(1.54)	9.9(0.39)	22.9(0.90)	7.1(0.28)	22.2(0.87)	20.6(0.81)
1/2	3/4-16	-CM-FL8-ST12	41.9(1.65)	11.2(0.44)	22.9(0.90)	10.4(0.41)	22.2(0.87)	22.2(0.87)
1/2	7/8-14	-CM-FL8-ST14	45.0(1.77)	12.7(0.50)	22.9(0.90)	10.4(0.41)	22.2(0.87)	25.4(1.00)
1/2	1 1/16-12	-CM-FL8-ST17	49.0(1.93)	15.0(0.59)	22.9(0.90)	10.4(0.41)	22.2(0.87)	31.8(1.25)
5/8	3/4-16	-CM-FL10-ST12	41.9(1.65)	11.2(0.44)	24.4(0.96)	10.7(0.42)	25.4(1.00)	23.8(0.94)
5/8	7/8-14	-CM-FL10-ST14	45.2(1.78)	12.7(0.50)	24.4(0.96)	12.7(0.50)	25.4(1.00)	25.4(1.00)
3/4	3/4-16	-CM-FL12-ST12	46.0(1.81)	11.2(0.44)	24.4(0.96)	10.7(0.42)	28.6(1.13)	27.0(1.06)
3/4	1 1/16-12	-CM-FL12-ST17	49.0(1.93)	15.0(0.59)	24.4(0.96)	15.7(0.62)	28.6(1.13)	31.8(1.25)
3/4	1 5/16-12	-CM-FL12-ST21	49.8(1.96)	15.0(0.59)	24.4(0.96)	16.0(0.63)	28.6(1.13)	38.1(1.50)
7/8	1 3/16-12	-CM-FL14-ST19	49.0(1.93)	15.0(0.59)	25.9(1.02)	18.3(0.72)	31.8(1.25)	34.9(1.37)
1	1 1/16-12	-CM-FL16-ST17	53.3(2.10)	15.0(0.59)	31.2(1.23)	16.8(0.66)	38.1(1.50)	34.9(1.37)
1	1 5/16-12	-CM-FL16-ST21	54.4(2.14)	15.0(0.59)	31.2(1.23)	22.4(0.88)	38.1(1.50)	38.1(1.50)
1 1/4	1 5/8-12	-CM-FL20-ST26	68.3(2.69)	15.0(0.59)	41.1(1.62)	27.7(1.09)	47.6(1.87)	47.6(1.87)
1 1/2	1 7/8-12	-CM-FL24-ST30	77.7(3.06)	15.0(0.59)	50.0(1.97)	34.0(1.34)	57.2(2.25)	54.0(2.13)

Штуцер с наружной резьбой

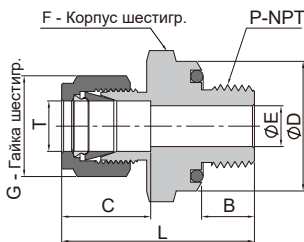
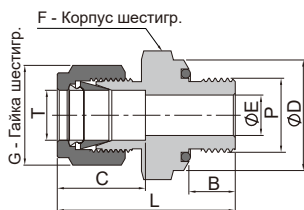
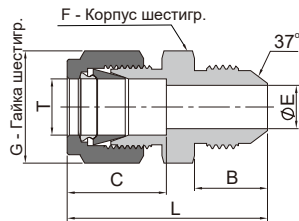
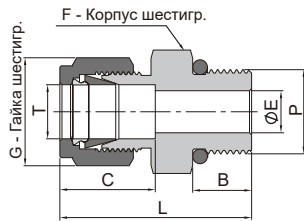

Дюймовая трубка			Прямая резьба SAE/MS (ST)					
D нар. трубки T (дюймы)	Размер резьбы P-SAE/MS	Артикул	Размеры, мм (дюймы)					
			L	B	C	E	G	F
1/4	7/16-20	-CML-FL4-ST7	57.4(2.26)	9.1(0.36)	15.2(0.60)	4.8(0.19)	14.3(0.56)	14.3(0.56)
1/2	3/4-16	-CML-FL8-ST12	76.5(3.01)	11.2(0.44)	22.9(0.90)	10.4(0.41)	22.2(0.87)	22.2(0.87)

Дюймовая трубка			Развальцовка, конус 37° (AN)					
D нар. трубки T (дюймы)	Размер раструба трубки AN	Артикул	Размеры, мм (дюймы)					
			L	B	C	E	G	F
1/16	1/8	-CM-FL1-AN2	27.2(1.07)	11.4(0.45)	8.6(0.34)	1.3(0.05)	7.9(0.31)	11.1(0.44)
1/8	1/8	-CM-FL2-AN2	32.3(1.27)	11.4(0.45)	12.7(0.50)	1.5(0.06)	11.1(0.44)	11.1(0.44)
1/8	1/4	-CM-FL2-AN4	35.1(1.38)	14.0(0.55)	12.7(0.50)	2.3(0.09)	11.1(0.44)	12.7(0.50)
3/16	3/16	-CM-FL3-AN3	33.5(1.32)	12.2(0.48)	13.7(0.54)	3.0(0.12)	12.7(0.50)	11.1(0.44)
1/4	1/4	-CM-FL4-AN4	37.6(1.48)	14.0(0.55)	15.2(0.60)	4.3(0.17)	14.3(0.56)	12.7(0.50)
5/16	5/16	-CM-FL5-AN5	38.4(1.51)	14.0(0.55)	16.2(0.64)	5.8(0.23)	15.9(0.63)	14.3(0.56)
3/8	1/4	-CM-FL6-AN4	39.6(1.56)	14.0(0.55)	16.8(0.66)	4.3(0.17)	17.5(0.69)	15.9(0.63)
3/8	3/8	-CM-FL6-AN6	39.6(1.56)	14.1(0.56)	16.8(0.66)	7.1(0.28)	17.5(0.69)	15.9(0.63)
1/2	1/2	-CM-FL8-AN8	46.0(1.81)	16.7(0.66)	22.8(0.90)	9.9(0.39)	22.2(0.87)	20.6(0.81)
5/8	5/8	-CM-FL10-AN10	49.0(1.93)	19.3(0.76)	24.5(0.96)	12.3(0.48)	25.4(1.00)	23.8(0.94)
3/4	3/4	-CM-FL12-AN12	53.3(2.10)	21.9(0.86)	24.4(0.96)	15.5(0.61)	28.6(1.13)	28.6(1.13)
1	1	-CM-FL16-AN16	61.5(2.42)	23.1(0.91)	31.2(1.23)	21.3(0.84)	38.1(1.50)	34.9(1.37)

Дюймовая трубка			Прямая резьба с уплотнительным кольцом SAE/MS (OST)						
D нар. трубки T (дюймы)	Размер резьбы P-SAE/MS	Артикул	Размеры, мм (дюймы)						
			L	B	C	E	G	F	D
1/16	5/16-24	-CM-FL1-OST5	26.7(1.05)	8.6(0.34)	8.6(0.34)	1.3(0.05)	7.9(0.31)	14.3(0.56)	14.0(0.55)
1/8	5/16-24	-CM-FL2-OST5	32.8(1.29)	8.6(0.34)	12.7(0.50)	2.3(0.09)	11.1(0.44)	14.3(0.56)	14.0(0.55)
3/16	3/8-24	-CM-FL3-OST6	34.3(1.35)	9.7(0.38)	13.7(0.54)	3.0(0.12)	12.7(0.50)	15.9(0.63)	15.7(0.62)
1/4	7/16-20	-CM-FL4-OST7	38.4(1.51)	10.4(0.41)	15.2(0.60)	4.8(0.19)	14.3(0.56)	19.1(0.75)	18.8(0.74)
5/16	1/2-20	-CM-FL5-OST8	40.6(1.60)	11.2(0.44)	16.3(0.64)	6.4(0.25)	15.9(0.63)	22.2(0.87)	21.8(0.86)
3/8	9/16-18	-CM-FL6-OST9	42.4(1.67)	11.9(0.47)	16.8(0.66)	7.1(0.28)	17.5(0.69)	23.8(0.94)	23.6(0.93)
1/2	3/4-16	-CM-FL8-OST12	46.0(1.81)	11.9(0.47)	22.9(0.90)	10.4(0.41)	22.2(0.87)	28.6(1.13)	28.4(1.12)
3/4	1 1/16-12	-CM-FL12-OST1752	52.3(2.06)	14.2(0.56)	24.4(0.96)	15.7(0.62)	28.6(1.13)	38.1(1.50)	37.8(1.49)
1	1 5/16-12	-CM-FL16-OST2158	58.2(2.29)	14.2(0.56)	31.2(1.23)	22.4(0.88)	38.1(1.50)	44.5(1.75)	44.2(1.74)

Дюймовая трубка			Резьба NPT с уплотнительным кольцом						
D нар. трубки T (дюймы)	Размер P-NPT	Артикул	Размеры, мм (дюймы)						
			L	B	C	E	G	F	D
1/8	1/8	-CM-FL2-ONS2	32.8(1.29)	7.1(0.28)	8.6(0.34)	2.3(0.09)	11.9(0.47)	19.1(0.75)	18.8(0.74)
1/4	1/8	-CM-FL4-ONS2	35.1(1.38)	7.1(0.28)	15.2(0.60)	4.8(0.19)	14.3(0.56)	19.1(0.75)	18.8(0.74)
1/4	1/4	-CM-FL4-ONS4	38.4(1.51)	9.7(0.38)	15.2(0.60)	4.8(0.19)	14.3(0.56)	23.8(0.94)	23.6(0.93)
3/8	1/4	-CM-FL6-ONS4	39.9(1.57)	9.7(0.38)	16.8(0.66)	7.1(0.28)	17.5(0.69)	23.8(0.94)	23.6(0.93)
3/8	3/8	-CM-FL6-ONS6	41.4(1.63)	10.4(0.41)	16.8(0.66)	7.1(0.28)	17.5(0.69)	28.6(1.13)	28.4(1.12)
3/8	1/2	-CM-FL6-ONS8	47.0(1.85)	13.5(0.53)	16.8(0.66)	7.1(0.28)	17.5(0.69)	33.3(1.31)	33.0(1.30)
1/2	1/2	-CM-FL8-ONS8	49.8(1.96)	13.5(0.53)	22.9(0.90)	10.4(0.41)	22.2(0.87)	33.3(1.31)	33.0(1.30)

Штуцер с наружной резьбой

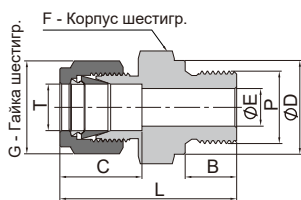

Дюймовая трубка			Метрическая резьба (MRS)						
D нар. трубки (дюймы)	P-размер метрической резьбы	Артикул	Размеры, мм (дюймы)						
			L	B	C	E	G	F	D
1/8	M14 x 1.5	-CM-FL2-MRS14	36.7(1.44)	12.0(0.47)	12.7(0.50)	2.3(0.09)	11.1(0.44)	19.1(0.75)	19.0(0.75)
1/8	M16 x 1.5	-CM-FL2-MRS16	37.5(1.48)	12.0(0.47)	12.7(0.50)	2.3(0.09)	11.1(0.44)	22.2(0.87)	21.0(0.83)
1/8	M18 x 1.5	-CM-FL2-MRS18	38.5(1.52)	12.0(0.47)	12.7(0.50)	2.3(0.09)	11.1(0.44)	23.8(0.94)	23.0(0.91)
1/8	M20 x 1.5	-CM-FL2-MRS20	41.1(1.62)	14.0(0.55)	12.7(0.50)	2.3(0.09)	11.1(0.44)	25.4(1.00)	25.0(0.98)
1/4	M14 x 1.5	-CM-FL4-MRS14	38.0(1.50)	12.0(0.47)	15.2(0.60)	4.8(0.19)	14.3(0.56)	19.1(0.75)	19.0(0.75)
1/4	M16 x 1.5	-CM-FL4-MRS16	39.9(1.57)	12.0(0.47)	15.2(0.60)	4.8(0.19)	14.3(0.56)	22.2(0.87)	21.0(0.83)
1/4	M18 x 1.5	-CM-FL4-MRS18	40.8(1.61)	12.0(0.47)	15.2(0.60)	4.8(0.19)	14.3(0.56)	23.8(0.94)	23.0(0.91)
1/4	M20 x 1.5	-CM-FL4-MRS20	43.6(1.72)	14.0(0.55)	15.2(0.60)	4.8(0.19)	14.3(0.56)	25.4(1.00)	25.0(0.98)
3/8	M14 x 1.5	-CM-FL6-MRS14	41.3(1.63)	12.0(0.47)	16.8(0.66)	7.1(0.28)	17.5(0.69)	19.1(0.75)	19.0(0.75)
3/8	M16 x 1.5	-CM-FL6-MRS16	41.3(1.63)	12.0(0.47)	16.8(0.66)	7.1(0.28)	17.5(0.69)	22.2(0.87)	21.0(0.83)
3/8	M18 x 1.5	-CM-FL6-MRS18	41.8(1.65)	12.0(0.47)	16.8(0.66)	7.1(0.28)	17.5(0.69)	23.8(0.94)	23.0(0.91)
3/8	M20 x 1.5	-CM-FL6-MRS20	45.1(1.78)	14.0(0.55)	16.8(0.66)	7.1(0.28)	17.5(0.69)	25.4(1.00)	25.0(0.98)
1/2	M16 x 1.5	-CM-FL8-MRS16	44.0(1.73)	12.0(0.47)	22.8(0.90)	9.0(0.35)	22.2(0.87)	22.2(0.87)	21.0(0.83)
1/2	M18 x 1.5	-CM-FL8-MRS18	44.0(1.73)	12.0(0.47)	22.9(0.90)	10.0(0.39)	22.2(0.87)	23.8(0.94)	23.0(0.91)
1/2	M20 x 1.5	-CM-FL8-MRS20	47.9(1.89)	14.0(0.55)	22.9(0.90)	10.4(0.41)	22.2(0.87)	25.4(1.00)	25.0(0.98)
1/2	M22 x 1.5	-CM-FL8-MRS22	48.5(1.91)	14.0(0.55)	22.9(0.90)	10.4(0.41)	22.2(0.87)	27.0(1.06)	27.0(1.06)

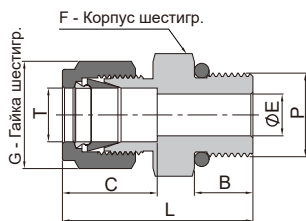

Совместим с прямой внутренней резьбой ISO 6149-1.

Дюймовая трубка			Метрическая резьба (MST)					
D нар. трубки (дюймы)	P-размер метрической резьбы	Артикул	Размеры, мм (дюймы)					
			L	B	C	E	G	F
1/4	M14X1.5	-CM-FL4-MST14	35.2(1.39)	11.0(0.43)	15.2(0.60)	4.8(0.19)	14.3(0.56)	19.1(0.75)
3/8	M14X1.5	-CM-FL6-MST14	36.7(1.44)	11.0(0.43)	16.8(0.66)	7.1(0.28)	17.5(0.69)	19.1(0.75)
3/8	M20X1.5	-CM-FL6-MST20	41.2(1.62)	14.0(0.55)	16.8(0.66)	7.1(0.28)	17.5(0.69)	27.0(1.06)
1/2	M14X1.5	-CM-FL8-MST14	40.2(1.58)	11.0(0.43)	22.9(0.90)	7.5(0.30)	22.2(0.87)	20.6(0.81)
1/2	M20X1.5	-CM-FL8-MST20	44.0(1.73)	14.0(0.55)	22.9(0.90)	10.4(0.41)	22.2(0.87)	27.0(1.06)

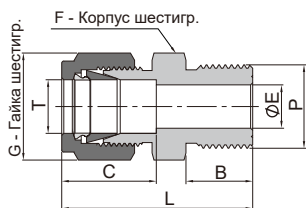

Дюймовая трубка			Метрическая резьба (MS)					
D нар. трубки (дюймы)	P-размер метрической резьбы	Артикул	Размеры, мм (дюймы)					
			L	B	C	E	G	F
1/16	M5 x 0.8	-CM-FL1-MS5	21.8(0.86)	8.0(0.31)	8.6(0.34)	1.3(0.05)	7.9(0.31)	7.9(0.31)
1/8	M14 x 1.5	-CM-FL2-MS14	34.8(1.37)	13.0(0.51)	12.7(0.50)	2.3(0.09)	11.1(0.44)	15.9(0.63)
1/8	M16 x 1.5	-CM-FL2-MS16	35.8(1.41)	14.0(0.55)	12.7(0.50)	2.3(0.09)	11.1(0.44)	17.5(0.69)
1/8	M18 x 1.5	-CM-FL2-MS18	37.2(1.46)	15.0(0.59)	12.7(0.50)	2.3(0.09)	11.1(0.44)	19.1(0.75)
1/8	M20 x 1.5	-CM-FL2-MS20	38.1(1.50)	16.0(0.63)	12.7(0.50)	2.3(0.09)	11.1(0.44)	22.2(0.87)
1/4	M14 x 1.5	-CM-FL4-MS14	36.9(1.45)	13.0(0.51)	15.2(0.60)	4.8(0.19)	14.3(0.56)	15.9(0.63)
1/4	M16 x 1.5	-CM-FL4-MS16	38.1(1.50)	14.0(0.55)	15.2(0.60)	4.8(0.19)	14.3(0.56)	17.5(0.69)
1/4	M18 x 1.5	-CM-FL4-MS18	39.5(1.56)	15.0(0.59)	15.2(0.60)	4.8(0.19)	14.3(0.56)	19.1(0.75)
1/4	M20 x 1.5	-CM-FL4-MS20	40.7(1.60)	16.0(0.63)	15.2(0.60)	4.8(0.19)	14.3(0.56)	22.2(0.87)
3/8	M10 x 1.0	-CM-FL6-MS10	36.4(1.43)	11.0(0.43)	16.8(0.66)	4.8(0.19)	17.5(0.69)	15.9(0.63)
3/8	M14 x 1.5	-CM-FL6-MS14	39.3(1.55)	13.0(0.51)	16.8(0.66)	7.1(0.28)	17.5(0.69)	15.9(0.63)
3/8	M16 x 1.5	-CM-FL6-MS16	39.7(1.56)	14.0(0.55)	16.8(0.66)	7.1(0.28)	17.5(0.69)	17.5(0.69)
3/8	M18 x 1.5	-CM-FL6-MS18	41.5(1.63)	15.0(0.59)	16.8(0.66)	7.1(0.28)	17.5(0.69)	19.1(0.75)
3/8	M20 x 1.5	-CM-FL6-MS20	42.3(1.67)	16.0(0.63)	16.8(0.66)	7.1(0.28)	17.5(0.69)	22.2(0.87)
1/2	M16 x 1.5	-CM-FL8-MS16	43.2(1.70)	14.0(0.55)	22.9(0.90)	8.4(0.33)	22.2(0.87)	20.6(0.81)
1/2	M18 x 1.5	-CM-FL8-MS18	43.7(1.72)	15.0(0.59)	22.9(0.90)	9.6(0.38)	22.2(0.87)	20.6(0.81)
1/2	M20 x 1.5	-CM-FL8-MS20	44.9(1.77)	16.0(0.63)	22.9(0.90)	10.4(0.41)	22.2(0.87)	22.2(0.87)
1/2	M22 x 1.5	-CM-FL8-MS22	47.0(1.85)	17.0(0.67)	22.9(0.90)	10.4(0.41)	22.2(0.87)	23.8(0.94)

Штуцер с наружной резьбой

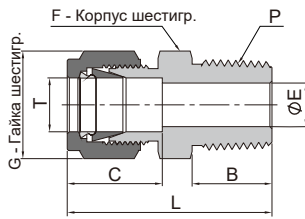

Метрическая трубка			Резьба NPT						
D нар. трубки T (мм)	Размер P-NPT	Артикул	Размеры, мм (дюймы)						
			L	B	C	E	G	F	
2	1/8	-CM-ML2-NS2	30.5(1.20)	9.7(0.38)	12.9(0.51)	1.7(0.07)	12.0(0.47)	12.0(0.47)	
3	1/8	-CM-ML3-NS2	30.5(1.20)	9.7(0.38)	12.9(0.51)	2.4(0.09)	12.0(0.47)	12.0(0.47)	
3	1/4	-CM-ML3-NS4	35.6(1.40)	14.2(0.56)	12.9(0.51)	2.4(0.09)	12.0(0.47)	14.0(0.55)	
4	1/8	-CM-ML4-NS2	31.2(1.23)	9.7(0.38)	13.7(0.54)	2.4(0.09)	12.0(0.47)	12.0(0.47)	
4	1/4	-CM-ML4-NS4	36.3(1.43)	14.2(0.56)	13.7(0.54)	2.4(0.09)	12.0(0.47)	14.0(0.55)	
6	1/8	-CM-ML6-NS2	32.8(1.29)	9.7(0.38)	15.3(0.60)	4.8(0.19)	14.0(0.55)	14.0(0.55)	
6	1/4	-CM-ML6-NS4	37.9(1.49)	14.2(0.56)	15.3(0.60)	4.8(0.19)	14.0(0.55)	14.0(0.55)	
6	3/8	-CM-ML6-NS6	38.4(1.51)	14.2(0.56)	15.3(0.60)	4.8(0.19)	14.0(0.55)	18.0(0.71)	
6	1/2	-CM-ML6-NS8	44.7(1.76)	19.1(0.75)	15.3(0.60)	4.8(0.19)	14.0(0.55)	22.0(0.87)	
8	1/8	-CM-ML8-NS2	34.2(1.35)	9.7(0.38)	16.2(0.64)	4.8(0.19)	16.0(0.63)	15.0(0.59)	
8	1/4	-CM-ML8-NS4	38.7(1.52)	14.2(0.56)	16.2(0.64)	6.4(0.25)	16.0(0.63)	15.0(0.59)	
8	3/8	-CM-ML8-NS6	39.3(1.55)	14.2(0.56)	16.2(0.64)	6.4(0.25)	16.0(0.63)	18.0(0.71)	
8	1/2	-CM-ML8-NS8	45.6(1.80)	19.1(0.75)	16.2(0.64)	6.4(0.25)	16.0(0.63)	22.0(0.87)	
10	1/8	-CM-ML10-NS2	36.3(1.43)	9.7(0.38)	17.2(0.68)	4.8(0.19)	19.0(0.75)	18.0(0.71)	
10	1/4	-CM-ML10-NS4	40.9(1.61)	14.2(0.56)	17.2(0.68)	7.1(0.28)	19.0(0.75)	18.0(0.71)	
10	3/8	-CM-ML10-NS6	40.9(1.61)	14.2(0.56)	17.2(0.68)	7.9(0.31)	19.0(0.75)	18.0(0.71)	
10	1/2	-CM-ML10-NS8	46.5(1.83)	19.1(0.75)	17.2(0.68)	7.9(0.31)	19.0(0.75)	22.0(0.87)	
10	3/4	-CM-ML10-NS12	48.0(1.89)	19.1(0.75)	17.2(0.68)	7.9(0.31)	19.0(0.75)	27.0(1.06)	
10	1	-CM-ML10-NS16	54.6(2.15)	23.9(0.94)	17.2(0.68)	7.9(0.31)	19.0(0.75)	35.0(1.38)	
12	1/8	-CM-ML12-NS2	38.8(1.53)	9.7(0.38)	22.8(0.90)	4.8(0.19)	22.0(0.87)	22.0(0.87)	
12	1/4	-CM-ML12-NS4	43.4(1.71)	14.2(0.56)	22.8(0.90)	7.1(0.28)	22.0(0.87)	22.0(0.87)	
12	3/8	-CM-ML12-NS6	43.4(1.71)	14.2(0.56)	22.8(0.90)	9.5(0.37)	22.0(0.87)	22.0(0.87)	
12	1/2	-CM-ML12-NS8	49.0(1.93)	19.1(0.75)	22.8(0.90)	9.5(0.37)	22.0(0.87)	22.0(0.87)	
12	3/4	-CM-ML12-NS12	49.1(1.93)	19.1(0.75)	22.8(0.90)	9.5(0.37)	22.0(0.87)	27.0(1.06)	
14	1/8	-CM-ML14-NS2	39.9(1.57)	9.7(0.38)	24.4(0.96)	4.8(0.19)	25.0(0.98)	24.0(0.94)	
14	1/4	-CM-ML14-NS4	44.1(1.74)	14.2(0.56)	24.4(0.96)	7.1(0.28)	25.0(0.98)	24.0(0.94)	
14	3/8	-CM-ML14-NS6	44.1(1.74)	14.2(0.56)	24.4(0.96)	9.5(0.37)	25.0(0.98)	24.0(0.94)	
14	1/2	-CM-ML14-NS8	49.0(1.93)	19.1(0.75)	24.4(0.96)	11.1(0.44)	25.0(0.98)	24.0(0.94)	
14	3/4	-CM-ML14-NS12	49.1(1.93)	19.1(0.75)	24.4(0.96)	11.1(0.44)	25.0(0.98)	27.0(1.06)	
15	1/2	-CM-ML15-NS8	49.0(1.93)	19.1(0.75)	24.4(0.96)	11.9(0.47)	25.0(0.98)	24.0(0.94)	
15	3/4	-CM-ML15-NS12	50.5(1.99)	19.1(0.75)	24.4(0.96)	11.9(0.47)	25.0(0.98)	27.0(1.06)	
15	1	-CM-ML15-NS16	57.1(2.25)	23.9(0.94)	24.4(0.96)	11.9(0.47)	25.0(0.98)	35.0(1.38)	
16	1/4	-CM-ML16-NS4	44.1(1.74)	14.2(0.56)	24.4(0.96)	7.1(0.28)	25.0(0.98)	24.0(0.94)	
16	3/8	-CM-ML16-NS6	44.1(1.74)	14.2(0.56)	24.4(0.96)	9.5(0.37)	25.0(0.98)	24.0(0.94)	
16	1/2	-CM-ML16-NS8	49.0(1.93)	19.1(0.75)	24.4(0.96)	11.9(0.47)	25.0(0.98)	24.0(0.94)	
16	3/4	-CM-ML16-NS12	50.5(1.99)	19.1(0.75)	24.4(0.96)	12.7(0.5)	25.0(0.98)	27.0(1.06)	
18	3/8	-CM-ML18-NS6	45.6(1.80)	14.2(0.56)	24.4(0.96)	9.5(0.37)	30.0(1.18)	27.0(1.06)	
18	1/2	-CM-ML18-NS8	50.5(1.99)	19.1(0.75)	24.4(0.96)	11.9(0.47)	30.0(1.18)	27.0(1.06)	
18	3/4	-CM-ML18-NS12	50.5(1.99)	19.1(0.75)	24.4(0.96)	15.1(0.59)	30.0(1.18)	27.0(1.06)	
20	1/2	-CM-ML20-NS8	52.3(2.06)	19.1(0.75)	26.0(1.02)	11.9(0.47)	32.0(1.26)	30.0(1.18)	
20	3/4	-CM-ML20-NS12	52.3(2.06)	19.1(0.75)	26.0(1.02)	15.9(0.63)	32.0(1.26)	30.0(1.18)	
20	1	-CM-ML20-NS16	57.1(2.25)	23.9(0.94)	26.0(1.02)	15.9(0.63)	32.0(1.26)	35.0(1.38)	
22	1/2	-CM-ML22-NS8	52.3(2.06)	19.1(0.75)	26.0(1.02)	11.9(0.47)	32.0(1.26)	30.0(1.18)	
22	3/4	-CM-ML22-NS12	52.3(2.06)	19.1(0.75)	26.0(1.02)	15.9(0.63)	32.0(1.26)	30.0(1.18)	
22	1	-CM-ML22-NS16	57.1(2.25)	23.9(0.94)	26.0(1.02)	18.3(0.72)	32.0(1.26)	35.0(1.38)	
25	1/2	-CM-ML25-NS8	57.5(2.26)	19.1(0.75)	31.3(1.23)	11.9(0.47)	38.0(1.50)	35.0(1.38)	
25	3/4	-CM-ML25-NS12	57.5(2.26)	19.1(0.75)	31.3(1.23)	15.9(0.63)	38.0(1.50)	35.0(1.38)	
25	1	-CM-ML25-NS16	62.3(2.45)	23.9(0.94)	31.3(1.23)	21.8(0.86)	38.0(1.50)	35.0(1.38)	
28	1	-CM-ML28-NS16	72.4(2.85)	23.9(0.94)	36.6(1.44)	21.8(0.86)	46.0(1.81)	41.0(1.61)	
28	1 1/4	-CM-ML28-NS20	73.1(2.88)	23.9(0.94)	36.6(1.44)	21.8(0.86)	46.0(1.81)	46.0(1.81)	
30	1 1/4	-CM-ML30-NS20	77.2(3.04)	23.9(0.94)	39.6(1.56)	26.2(1.03)	50.0(1.97)	46.0(1.81)	
32	1 1/4	-CM-ML32-NS20	79.6(3.13)	23.9(0.94)	42.0(1.65)	28.6(1.13)	50.0(1.97)	46.0(1.81)	
38	1 1/2	-CM-ML38-NS24	91.6(3.61)	26.2(1.03)	49.4(1.94)	33.7(1.33)	60.0(2.36)	55.0(2.17)	

Штуцер с наружной резьбой

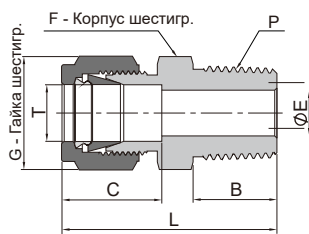

Метрическая трубка			Коническая резьба ISO (RT)					
D нар. трубки T (мм)	Размер P-RT	Артикул	Размеры, мм (дюймы)					
			L	B	C	E	G	F
2	1/8	-CM-ML2-RT2	30.5(1.20)	9.7(0.38)	12.9(0.51)	1.7(0.07)	12.0(0.47)	12.0(0.47)
3	1/8	-CM-ML3-RT2	30.5(1.20)	9.7(0.38)	12.9(0.51)	2.4(0.09)	12.0(0.47)	12.0(0.47)
3	1/4	-CM-ML3-RT4	35.6(1.40)	14.2(0.56)	12.9(0.51)	2.4(0.09)	12.0(0.47)	14.0(0.55)
4	1/8	-CM-ML4-RT2	31.2(1.23)	9.7(0.38)	13.7(0.54)	2.4(0.09)	12.0(0.47)	12.0(0.47)
4	1/4	-CM-ML4-RT4	36.3(1.43)	14.2(0.56)	13.7(0.54)	2.4(0.09)	12.0(0.47)	14.0(0.55)
6	1/8	-CM-ML6-RT2	32.8(1.29)	9.7(0.38)	15.3(0.60)	4.8(0.19)	14.0(0.55)	14.0(0.55)
6	1/4	-CM-ML6-RT4	37.9(1.49)	14.2(0.56)	15.3(0.60)	4.8(0.19)	14.0(0.55)	14.0(0.55)
6	3/8	-CM-ML6-RT6	38.4(1.51)	14.2(0.56)	15.3(0.60)	4.8(0.19)	14.0(0.55)	18.0(0.71)
6	1/2	-CM-ML6-RT8	44.7(1.76)	19.1(0.75)	15.3(0.60)	4.8(0.19)	14.0(0.55)	22.0(0.87)
8	1/8	-CM-ML8-RT2	34.2(1.35)	9.7(0.38)	16.2(0.64)	4.8(0.19)	16.0(0.63)	15.0(0.59)
8	1/4	-CM-ML8-RT4	38.7(1.52)	14.2(0.56)	16.2(0.64)	6.4(0.25)	16.0(0.63)	15.0(0.59)
8	3/8	-CM-ML8-RT6	39.2(1.54)	14.2(0.56)	16.2(0.64)	6.4(0.25)	16.0(0.63)	18.0(0.71)
8	1/2	-CM-ML8-RT8	45.6(1.80)	19.1(0.75)	16.2(0.64)	6.4(0.25)	16.0(0.63)	22.0(0.87)
10	1/8	-CM-ML10-RT2	36.3(1.43)	9.7(0.38)	17.2(0.68)	4.8(0.19)	19.0(0.75)	18.0(0.71)
10	1/4	-CM-ML10-RT4	40.9(1.61)	14.2(0.56)	17.2(0.68)	7.1(0.28)	19.0(0.75)	18.0(0.71)
10	3/8	-CM-ML10-RT6	40.9(1.61)	14.2(0.56)	17.2(0.68)	7.9(0.31)	19.0(0.75)	18.0(0.71)
10	1/2	-CM-ML10-RT8	46.5(1.83)	19.1(0.75)	17.2(0.68)	7.9(0.31)	19.0(0.75)	22.0(0.87)
10	3/4	-CM-ML10-RT12	48.0(1.89)	19.1(0.75)	17.2(0.68)	7.9(0.31)	19.0(0.75)	27.0(1.06)
12	1/8	-CM-ML12-RT2	38.9(1.53)	9.7(0.38)	22.8(0.90)	4.8(0.19)	22.0(0.87)	22.0(0.87)
12	1/4	-CM-ML12-RT4	43.4(1.71)	14.2(0.56)	22.8(0.90)	7.1(0.28)	22.0(0.87)	22.0(0.87)
12	3/8	-CM-ML12-RT6	43.4(1.71)	14.2(0.56)	22.8(0.90)	9.5(0.37)	22.0(0.87)	22.0(0.87)
12	1/2	-CM-ML12-RT8	49.0(1.93)	19.1(0.75)	22.8(0.90)	9.5(0.37)	22.0(0.87)	22.0(0.87)
12	3/4	-CM-ML12-RT12	50.5(1.99)	19.1(0.75)	22.8(0.90)	9.5(0.37)	22.0(0.87)	27.0(1.06)
14	1/8	-CM-ML14-RT2	39.9(1.57)	9.7(0.38)	24.4(0.96)	4.8(0.19)	25.0(0.98)	24.0(0.94)
14	1/4	-CM-ML14-RT4	44.1(1.74)	14.2(0.56)	24.4(0.96)	7.1(0.28)	25.0(0.98)	24.0(0.94)
14	3/8	-CM-ML14-RT6	44.1(1.74)	14.2(0.56)	24.4(0.96)	9.5(0.37)	25.0(0.98)	24.0(0.94)
14	1/2	-CM-ML14-RT8	49.0(1.93)	19.1(0.75)	24.4(0.96)	11.1(0.44)	25.0(0.98)	24.0(0.94)
14	3/4	-CM-ML14-RT12	50.5(1.99)	19.1(0.75)	24.4(0.96)	11.1(0.44)	25.0(0.98)	27.0(1.06)
15	1/2	-CM-ML15-RT8	49.0(1.93)	19.1(0.75)	24.4(0.96)	11.9(0.47)	25.0(0.98)	24.0(0.94)
16	1/4	-CM-ML16-RT4	44.1(1.74)	14.2(0.56)	24.4(0.96)	7.1(0.28)	25.0(0.98)	24.0(0.94)
16	3/8	-CM-ML16-RT6	44.1(1.74)	14.2(0.56)	24.4(0.96)	9.5(0.37)	25.0(0.98)	24.0(0.94)
16	1/2	-CM-ML16-RT8	49.0(1.93)	19.1(0.75)	24.4(0.96)	11.9(0.47)	25.0(0.98)	24.0(0.94)
16	3/4	-CM-ML16-RT12	50.5(1.99)	19.1(0.75)	24.4(0.96)	12.7(0.5)	25.0(0.98)	27.0(1.06)
18	1/2	-CM-ML18-RT8	50.5(1.99)	19.1(0.75)	24.4(0.96)	11.9(0.47)	30.0(1.18)	27.0(1.06)
18	3/4	-CM-ML18-RT12	50.5(1.99)	19.1(0.75)	24.4(0.96)	15.1(0.59)	30.0(1.18)	27.0(1.06)
20	1/2	-CM-ML20-RT8	52.3(2.06)	19.1(0.75)	26.0(1.02)	11.9(0.47)	32.0(1.26)	30.0(1.18)
20	3/4	-CM-ML20-RT12	52.3(2.06)	19.1(0.75)	26.0(1.02)	15.9(0.63)	32.0(1.26)	30.0(1.18)
22	3/4	-CM-ML22-RT12	52.3(2.06)	19.1(0.75)	26.0(1.02)	15.9(0.63)	32.0(1.26)	30.0(1.18)
22	1	-CM-ML22-RT16	57.1(2.25)	23.9(0.94)	26.0(1.02)	18.3(0.72)	32.0(1.26)	35.0(1.38)
25	1/2	-CM-ML25-RT8	57.5(2.26)	19.1(0.75)	31.3(1.23)	11.9(0.47)	38.0(1.50)	35.0(1.38)
25	3/4	-CM-ML25-RT12	57.5(2.26)	19.1(0.75)	31.3(1.23)	15.9(0.63)	38.0(1.50)	35.0(1.38)
25	1	-CM-ML25-RT16	62.3(2.45)	23.9(0.94)	31.3(1.23)	21.8(0.86)	38.0(1.50)	35.0(1.38)
28	1	-CM-ML28-RT16	72.4(2.85)	23.9(0.94)	36.6(1.44)	21.8(0.86)	46.0(1.81)	41.0(1.61)
28	1 1/4	-CM-ML28-RT20	73.1(2.88)	23.9(0.94)	36.6(1.44)	21.8(0.86)	46.0(1.81)	46.0(1.81)
30	1 1/4	-CM-ML30-RT20	77.2(3.04)	23.9(0.94)	39.6(1.56)	26.2(1.03)	50.0(1.97)	46.0(1.81)
32	1 1/4	-CM-ML32-RT20	79.6(3.13)	23.9(0.94)	42.0(1.65)	28.6(1.13)	50.0(1.97)	46.0(1.81)
38	1 1/2	-CM-ML38-RT24	91.6(3.61)	26.2(1.03)	49.4(1.94)	33.7(1.33)	60.0(2.36)	55.0(2.17)

Штуцер с наружной резьбой

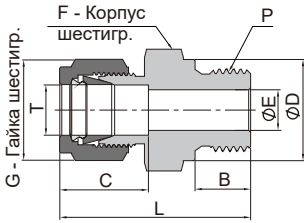

Метрическая труба			Цилиндрическая резьба по ISO (RS)						
D нар. трубки T (мм)	Размер P-RS	Артикул	Размеры, мм (дюймы)						
			L	B	C	E	G	F	D
2	1/8	-CM-ML2-RS2	30.0(1.18)	7.1(0.28)	12.9(0.51)	1.7(0.07)	12.0(0.47)	14.0(0.55)	13.7(0.54)
3	1/8	-CM-ML3-RS2	30.0(1.18)	7.1(0.28)	12.9(0.51)	2.4(0.09)	12.0(0.47)	14.0(0.55)	13.7(0.54)
3	1/4	-CM-ML3-RS4	35.3(1.39)	11.2(0.44)	12.9(0.51)	2.4(0.09)	12.0(0.47)	19.0(0.75)	18.0(0.71)
4	1/8	-CM-ML4-RS2	30.7(1.21)	7.1(0.28)	13.7(0.54)	2.4(0.09)	12.0(0.47)	14.0(0.55)	13.7(0.54)
4	1/4	-CM-ML4-RS4	36.0(1.42)	11.2(0.44)	13.7(0.54)	2.4(0.09)	12.0(0.47)	19.0(0.75)	18.0(0.71)
6	1/8	-CM-ML6-RS2	32.3(1.27)	7.1(0.28)	15.3(0.60)	4.0(0.16)	14.0(0.55)	14.0(0.55)	13.7(0.54)
6	1/4	-CM-ML6-RS4	37.6(1.48)	11.2(0.44)	15.3(0.60)	4.8(0.19)	14.0(0.55)	19.0(0.75)	18.0(0.71)
6	3/8	-CM-ML6-RS6	38.9(1.53)	11.2(0.44)	15.3(0.60)	4.8(0.19)	14.0(0.55)	22.0(0.87)	21.6(0.85)
6	1/2	-CM-ML6-RS8	44.7(1.76)	14.2(0.56)	15.3(0.60)	4.8(0.19)	14.0(0.55)	27.0(1.06)	25.9(1.02)
8	1/8	-CM-ML8-RS2	33.2(1.31)	7.1(0.28)	16.2(0.64)	4.0(0.16)	16.0(0.63)	15.0(0.59)	13.7(0.54)
8	1/4	-CM-ML8-RS4	38.5(1.52)	11.2(0.44)	16.2(0.64)	6.4(0.25)	16.0(0.63)	19.0(0.75)	18.0(0.71)
8	3/8	-CM-ML8-RS6	39.8(1.57)	11.2(0.44)	16.2(0.64)	6.4(0.25)	16.0(0.63)	22.0(0.87)	21.6(0.85)
8	1/2	-CM-ML8-RS8	45.6(1.80)	14.2(0.56)	16.2(0.64)	6.4(0.25)	16.0(0.63)	27.0(1.06)	25.9(1.02)
8	3/4	-CM-ML8-RS12	49.5(1.95)	15.7(0.62)	16.2(0.64)	6.4(0.25)	16.0(0.63)	35.0(1.38)	32.0(1.26)
10	1/4	-CM-ML10-RS4	39.4(1.55)	11.2(0.44)	17.2(0.68)	5.9(0.23)	19.0(0.75)	19.0(0.75)	18.0(0.71)
10	3/8	-CM-ML10-RS6	40.6(1.60)	11.2(0.44)	17.2(0.68)	7.9(0.31)	19.0(0.75)	22.0(0.87)	21.6(0.85)
10	1/2	-CM-ML10-RS8	46.5(1.83)	14.2(0.56)	17.2(0.68)	7.9(0.31)	19.0(0.75)	27.0(1.06)	25.9(1.02)
12	1/4	-CM-ML12-RS4	42.6(1.68)	11.2(0.44)	22.8(0.90)	5.9(0.23)	22.0(0.87)	22.0(0.87)	18.0(0.71)
12	3/8	-CM-ML12-RS6	43.1(1.70)	11.2(0.44)	22.8(0.90)	7.9(0.31)	22.0(0.87)	22.0(0.87)	21.6(0.85)
12	1/2	-CM-ML12-RS8	49.0(1.93)	14.2(0.56)	22.8(0.90)	9.5(0.37)	22.0(0.87)	27.0(1.06)	25.9(1.02)
12	3/4	-CM-ML12-RS12	52.8(2.08)	15.7(0.62)	22.8(0.90)	9.5(0.37)	22.0(0.87)	35.0(1.38)	32.0(1.26)
14	1/4	-CM-ML14-RS4	44.2(1.74)	11.2(0.44)	24.4(0.96)	6.4(0.25)	25.0(0.98)	24.0(0.94)	18.0(0.71)
14	3/8	-CM-ML14-RS6	43.9(1.73)	11.2(0.44)	24.4(0.96)	7.9(0.31)	25.0(0.98)	24.0(0.94)	21.6(0.85)
14	1/2	-CM-ML14-RS8	49.0(1.93)	14.2(0.56)	24.4(0.96)	11.1(0.44)	25.0(0.98)	27.0(1.06)	25.9(1.02)
14	3/4	-CM-ML14-RS12	52.8(2.08)	15.7(0.62)	24.4(0.96)	11.1(0.44)	25.0(0.98)	35.0(1.38)	32.0(1.26)
15	3/8	-CM-ML15-RS6	43.9(1.73)	11.2(0.44)	24.4(0.96)	7.9(0.31)	25.0(0.98)	24.0(0.94)	21.6(0.85)
15	1/2	-CM-ML15-RS8	49.0(1.93)	14.2(0.56)	24.4(0.96)	11.9(0.47)	25.0(0.98)	27.0(1.06)	25.9(1.02)
15	3/4	-CM-ML15-RS12	52.8(2.08)	15.7(0.62)	24.4(0.96)	11.9(0.47)	25.0(0.98)	35.0(1.38)	32.0(1.26)
16	3/8	-CM-ML16-RS6	43.9(1.73)	11.2(0.44)	24.4(0.96)	7.9(0.31)	25.0(0.98)	24.0(0.94)	21.6(0.85)
16	1/2	-CM-ML16-RS8	49.0(1.93)	14.2(0.56)	24.4(0.96)	11.9(0.47)	25.0(0.98)	27.0(1.06)	25.9(1.02)
16	3/4	-CM-ML16-RS12	52.8(2.08)	15.7(0.62)	24.4(0.96)	12.7(0.5)	25.0(0.98)	35.0(1.38)	32.0(1.26)
18	1/2	-CM-ML18-RS8	49.0(1.93)	14.2(0.56)	24.4(0.96)	11.9(0.47)	30.0(1.18)	27.0(1.06)	25.9(1.02)
18	3/4	-CM-ML18-RS12	52.8(2.08)	15.7(0.62)	24.4(0.96)	15.1(0.59)	30.0(1.18)	35.0(1.38)	32.0(1.26)
20	1/2	-CM-ML20-RS8	50.5(1.99)	14.2(0.56)	26.0(1.02)	11.9(0.47)	32.0(1.26)	30.0(1.18)	25.9(1.02)
20	3/4	-CM-ML20-RS12	52.8(2.08)	15.7(0.62)	26.0(1.02)	15.9(0.63)	32.0(1.26)	35.0(1.38)	32.0(1.26)
22	3/4	-CM-ML22-RS12	52.8(2.08)	15.7(0.62)	26.0(1.02)	15.9(0.63)	32.0(1.26)	35.0(1.38)	32.0(1.26)
22	1	-CM-ML22-RS16	55.3(2.18)	18.3(0.72)	26.0(1.02)	18.3(0.72)	32.0(1.26)	41.0(1.61)	39.1(1.54)
25	3/4	-CM-ML25-RS12	57.5(2.26)	15.7(0.62)	31.3(1.23)	15.9(0.63)	38.0(1.50)	35.0(1.38)	32.0(1.26)
25	1	-CM-ML25-RS16	60.1(2.37)	18.3(0.72)	31.3(1.23)	19.8(0.78)	38.0(1.50)	41.0(1.61)	39.1(1.54)
28	1	-CM-ML28-RS16	70.1(2.76)	18.3(0.72)	36.6(1.44)	19.8(0.78)	46.0(1.81)	41.0(1.61)	39.1(1.54)
28	1 1/4	-CM-ML28-RS20	73.9(2.91)	19.8(0.78)	36.6(1.44)	21.8(0.86)	46.0(1.81)	50.0(1.97)	49.0(1.93)
30	1 1/4	-CM-ML30-RS20	79.2(3.12)	19.8(0.78)	39.6(1.56)	26.2(1.03)	50.0(1.97)	50.0(1.97)	49.0(1.93)
32	1 1/4	-CM-ML32-RS20	78.9(3.11)	19.8(0.78)	42.0(1.65)	28.6(1.13)	50.0(1.97)	50.0(1.97)	49.0(1.93)
38	1 1/2	-CM-ML38-RS24	90.8(3.57)	20.6(0.81)	49.4(1.94)	31.8(1.25)	60.0(2.36)	55.0(2.17)	54.7(2.15)

Штуцер с наружной резьбой

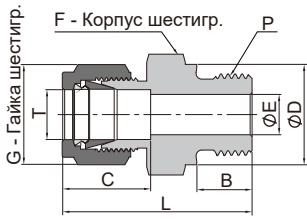

Метрическая трубка			Цилиндрическая резьба по ISO (RP)						
D нар. трубки T (мм)	Размер P-RP	Артикул	Размеры, мм (дюймы)						
			L	B	C	E	G	F	D
3	1/8	-CM-ML3-RP2	30.0(1.18)	7.1(0.28)	12.9(0.51)	2.4(0.09)	12.0(0.47)	14.0(0.55)	13.8(0.54)
3	1/4	-CM-ML3-RP4	35.3(1.39)	11.2(0.44)	12.9(0.51)	2.4(0.09)	12.0(0.47)	19.0(0.75)	18.0(0.71)
4	1/8	-CM-ML4-RP2	30.7(1.21)	7.1(0.28)	13.7(0.54)	2.4(0.09)	12.0(0.47)	14.0(0.55)	13.8(0.54)
6	1/8	-CM-ML6-RP2	32.3(1.27)	7.1(0.28)	15.3(0.60)	4.0(0.16)	14.0(0.55)	14.0(0.55)	13.8(0.54)
6	1/4	-CM-ML6-RP4	37.6(1.48)	11.2(0.44)	15.3(0.60)	4.8(0.19)	14.0(0.55)	19.0(0.75)	18.0(0.71)
6	3/8	-CM-ML6-RP6	38.9(1.53)	11.2(0.44)	15.3(0.60)	4.8(0.19)	14.0(0.55)	22.0(0.87)	21.8(0.86)
6	1/2	-CM-ML6-RP8	44.7(1.76)	14.2(0.56)	15.3(0.60)	4.8(0.19)	14.0(0.55)	27.0(1.06)	26.0(1.02)
8	1/8	-CM-ML8-RP2	33.3(1.31)	7.1(0.28)	16.2(0.64)	4.0(0.16)	16.0(0.63)	15.0(0.59)	13.8(0.54)
8	1/4	-CM-ML8-RP4	38.5(1.52)	11.2(0.44)	16.2(0.64)	5.9(0.23)	16.0(0.63)	19.0(0.75)	18.0(0.71)
8	3/8	-CM-ML8-RP6	39.8(1.57)	11.2(0.44)	16.2(0.64)	6.4(0.25)	16.0(0.63)	22.0(0.87)	21.8(0.86)
8	1/2	-CM-ML8-RP8	45.6(1.80)	14.2(0.56)	16.2(0.64)	6.4(0.25)	16.0(0.63)	27.0(1.06)	26.0(1.02)
10	1/4	-CM-ML10-RP4	39.4(1.55)	11.2(0.44)	17.2(0.68)	5.9(0.23)	19.0(0.75)	19.0(0.75)	18.0(0.71)
10	3/8	-CM-ML10-RP6	42.8(1.69)	11.2(0.44)	17.2(0.68)	7.9(0.31)	19.0(0.75)	22.0(0.87)	21.8(0.86)
10	1/2	-CM-ML10-RP8	46.5(1.83)	14.2(0.56)	17.2(0.68)	7.9(0.31)	19.0(0.75)	27.0(1.06)	26.0(1.02)
12	1/4	-CM-ML12-RP4	42.6(1.68)	11.2(0.44)	22.8(0.90)	5.9(0.23)	22.0(0.87)	22.0(0.87)	18.0(0.71)
12	3/8	-CM-ML12-RP6	43.1(1.70)	11.2(0.44)	22.8(0.90)	7.9(0.31)	22.0(0.87)	22.0(0.87)	21.8(0.86)
12	1/2	-CM-ML12-RP8	52.1(2.05)	14.2(0.56)	22.8(0.90)	9.5(0.37)	22.0(0.87)	27.0(1.06)	26.0(1.02)
12	3/4	-CM-ML12-RP12	52.8(2.08)	15.7(0.62)	22.8(0.90)	9.5(0.37)	22.0(0.87)	35.0(1.38)	32.0(1.26)
15	1/2	-CM-ML15-RP8	47.5(1.87)	14.2(0.56)	24.4(0.96)	11.9(0.47)	25.0(0.98)	27.0(1.06)	26.0(1.02)
16	3/8	-CM-ML16-RP6	43.9(1.73)	11.2(0.44)	24.4(0.96)	7.9(0.31)	25.0(0.98)	24.0(0.94)	21.8(0.86)
16	1/2	-CM-ML16-RP8	49.0(1.93)	14.2(0.56)	24.4(0.96)	11.9(0.47)	25.0(0.98)	27.0(1.06)	26.0(1.02)
18	1/2	-CM-ML18-RP8	49.0(1.93)	14.2(0.56)	24.4(0.96)	11.9(0.47)	30.0(1.18)	27.0(1.06)	26.0(1.02)
18	3/4	-CM-ML18-RP12	52.8(2.08)	15.7(0.62)	24.4(0.96)	15.1(0.59)	30.0(1.18)	35.0(1.38)	32.0(1.26)
20	1/2	-CM-ML20-RP8	50.5(1.99)	14.2(0.56)	26.0(1.02)	11.9(0.47)	32.0(1.26)	30.0(1.18)	26.0(1.02)
20	3/4	-CM-ML20-RP12	52.8(2.08)	15.7(0.62)	26.0(1.02)	15.9(0.63)	32.0(1.26)	35.0(1.38)	32.0(1.26)
22	3/4	-CM-ML22-RP12	52.8(2.08)	15.7(0.62)	26.0(1.02)	15.9(0.63)	32.0(1.26)	35.0(1.38)	32.0(1.26)
22	1	-CM-ML22-RP16	55.3(2.18)	18.3(0.72)	26.0(1.02)	18.3(0.72)	32.0(1.26)	41.0(1.61)	39.0(1.54)
25	3/4	-CM-ML25-RP12	57.5(2.26)	15.7(0.62)	31.3(1.23)	15.9(0.63)	38.0(1.50)	35.0(1.38)	32.0(1.26)
25	1	-CM-ML25-RP16	60.1(2.37)	18.3(0.72)	31.3(1.23)	19.8(0.78)	38.0(1.50)	41.0(1.61)	39.0(1.54)
28	1	-CM-ML28-RP16	70.1(2.76)	18.3(0.72)	36.6(1.44)	19.8(0.78)	46.0(1.81)	41.0(1.61)	39.0(1.54)
28	1 1/4	-CM-ML28-RP20	73.9(2.91)	19.8(0.78)	36.6(1.44)	21.8(0.86)	46.0(1.81)	50.0(1.97)	49.0(1.93)
30	1 1/4	-CM-ML30-RP20	76.5(3.01)	19.8(0.78)	39.6(1.56)	26.2(1.03)	50.0(1.97)	50.0(1.97)	49.0(1.93)
32	1 1/4	-CM-ML32-RP20	78.9(3.11)	19.8(0.78)	42.0(1.65)	28.6(1.13)	50.0(1.97)	50.0(1.97)	49.0(1.93)
38	1 1/2	-CM-ML38-RP24	89.3(3.52)	20.6(0.81)	49.4(1.94)	31.8(1.25)	60.0(2.36)	55.0(2.17)	54.7(2.15)

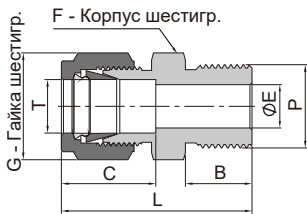

Метрическая трубка			Цилиндрическая резьба ISO (BP)					
D нар. трубки T (мм)	Размер P-BP	Артикул	Размеры, мм (дюймы)					
			L	B	C	E	G	F
6	1/4	-CM-ML6-BP4	36.9(1.45)	12.9(0.51)	15.3(0.60)	4.8(0.19)	14.0(0.55)	14.0(0.55)
6	3/8	-CM-ML6-BP6	39.5(1.56)	14.2(0.56)	15.3(0.60)	4.8(0.19)	14.0(0.55)	18.0(0.71)
8	1/8	-CM-ML8-BP2	33.9(1.33)	9.8(0.39)	16.2(0.64)	4.0(0.16)	16.0(0.63)	14.0(0.55)
8	1/4	-CM-ML8-BP4	37.0(1.46)	12.9(0.51)	16.2(0.64)	6.4(0.25)	16.0(0.63)	14.0(0.55)
8	3/8	-CM-ML8-BP6	39.3(1.55)	14.2(0.56)	16.2(0.64)	6.4(0.25)	16.0(0.63)	18.0(0.71)
8	1/2	-CM-ML8-BP8	45.4(1.79)	18.8(0.74)	16.2(0.64)	6.4(0.25)	16.0(0.63)	22.0(0.87)
10	1/4	-CM-ML10-BP4	39.5(1.56)	12.9(0.51)	17.2(0.68)	5.9(0.23)	19.0(0.75)	18.0(0.71)
10	1/2	-CM-ML10-BP8	46.3(1.82)	18.8(0.74)	17.2(0.68)	7.9(0.31)	19.0(0.75)	22.0(0.87)
12	3/8	-CM-ML12-BP6	44.2(1.74)	14.2(0.56)	22.8(0.90)	7.9(0.31)	22.0(0.87)	22.0(0.87)
12	1/2	-CM-ML12-BP8	52.1(2.05)	18.8(0.74)	22.8(0.90)	9.5(0.37)	22.0(0.87)	22.0(0.87)
14	1/4	-CM-ML14-BP4	42.9(1.69)	12.9(0.51)	24.4(0.96)	5.9(0.23)	25.0(0.98)	24.0(0.94)
16	3/8	-CM-ML16-BP6	43.4(1.71)	14.2(0.56)	24.4(0.96)	7.9(0.31)	25.0(0.98)	24.0(0.94)
16	1/2	-CM-ML16-BP8	47.9(1.89)	18.8(0.74)	24.4(0.96)	9.5(0.37)	25.0(0.98)	24.0(0.94)
18	1/2	-CM-ML18-BP8	49.8(1.96)	18.8(0.74)	24.4(0.96)	9.5(0.37)	30.0(1.18)	27.0(1.06)

Штуцер с наружной резьбой

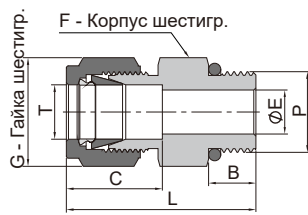

Совместим с прямой внутренней резьбой SAE J1926-1, ISO 11926-1 и MS 16142.

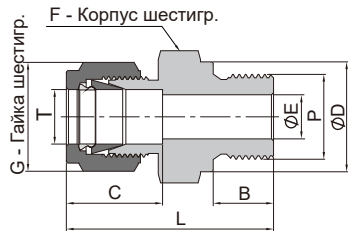

Метрическая трубка			Прямая резьба SAE/MS (ST)					
D нар. трубки T (мм)	Размер резьбы P-SAE/MS	Артикул	Размеры, мм (дюймы)					
			L	B	C	E	G	F
6	9/16-18	-CM-ML6-ST9	35.6(1.40)	9.9(0.39)	15.3(0.60)	4.8(0.19)	14.0(0.55)	18.0(0.71)
10	9/16-18	-CM-ML10-ST9	37.3(1.47)	9.9(0.39)	17.2(0.68)	7.1(0.28)	19.0(0.75)	22.0(0.87)
10	3/4-16	-CM-ML10-ST12	39.4(1.55)	11.2(0.44)	17.2(0.68)	7.9(0.31)	19.0(0.75)	22.0(0.87)
12	7/16-20	-CM-ML12-ST7	40.6(1.60)	9.1(0.36)	22.8(0.90)	5.2(0.20)	22.0(0.87)	22.0(0.87)
12	9/16-18	-CM-ML12-ST9	39.9(1.57)	9.9(0.39)	22.8(0.90)	7.1(0.28)	22.0(0.87)	22.0(0.87)

Метрическая трубка			Метрическая резьба (MRS)						
D нар. трубки T (мм)	P-размер метрической резьбы	Артикул	Размеры, мм (дюймы)						
			L	B	C	E	G	F	D
6	M8 x 1	-CM-ML6-MRS8	33.3(1.31)	8.0(0.31)	15.3(0.60)	3.0(0.12)	14.0(0.55)	14.0(0.55)	12.0(0.47)
6	M10 x 1	-CM-ML6-MRS10	33.3(1.31)	8.0(0.31)	15.3(0.60)	4.0(0.16)	14.0(0.55)	14.0(0.55)	14.0(0.55)
6	M12 x 1.5	-CM-ML6-MRS12	38.2(1.50)	12.0(0.47)	15.3(0.60)	4.8(0.19)	14.0(0.55)	18.0(0.71)	17.0(0.67)
6	M14 x 1.5	-CM-ML6-MRS14	39.7(1.56)	12.0(0.47)	15.3(0.60)	4.8(0.19)	14.0(0.55)	22.0(0.87)	19.0(0.75)
8	M8 x 1	-CM-ML8-MRS8	34.1(1.34)	8.0(0.31)	16.2(0.64)	3.0(0.12)	16.0(0.63)	14.0(0.55)	12.0(0.47)
8	M10 x 1	-CM-ML8-MRS10	34.1(1.34)	8.0(0.31)	16.2(0.64)	5.0(0.20)	16.0(0.63)	14.0(0.55)	14.0(0.55)
8	M12 x 1.5	-CM-ML8-MRS12	40.4(1.59)	12.0(0.47)	16.2(0.64)	6.0(0.24)	16.0(0.63)	18.0(0.71)	17.0(0.67)
8	M14 x 1.5	-CM-ML8-MRS14	40.4(1.59)	12.0(0.47)	16.2(0.64)	6.4(0.25)	16.0(0.63)	19.0(0.75)	19.0(0.75)
10	M12 x 1.5	-CM-ML10-MRS12	40.7(1.60)	12.0(0.47)	17.2(0.68)	6.0(0.24)	19.0(0.75)	18.0(0.71)	17.0(0.67)
10	M14 x 1.5	-CM-ML10-MRS14	39.5(1.56)	12.0(0.47)	17.2(0.68)	7.9(0.31)	19.0(0.75)	19.0(0.75)	19.0(0.75)
12	M16 x 1.5	-CM-ML12-MRS16	45.5(1.79)	12.0(0.47)	22.8(0.90)	9.0(0.35)	22.0(0.87)	22.0(0.87)	21.0(0.83)
12	M20 x 1.5	-CM-ML12-MRS20	47.2(1.86)	14.0(0.55)	22.8(0.90)	9.5(0.37)	22.0(0.87)	25.0(0.98)	25.0(0.98)
12	M22 x 1.5	-CM-ML12-MRS22	47.5(1.87)	14.0(0.55)	22.8(0.90)	9.5(0.37)	22.0(0.87)	27.0(1.06)	27.0(1.06)
14	M14 x 1.5	-CM-ML14-MRS14	44.9(1.77)	12.0(0.47)	24.4(0.96)	8.0(0.31)	25.0(0.98)	24.0(0.94)	19.0(0.75)
14	M20 x 1.5	-CM-ML14-MRS20	48.0(1.89)	14.0(0.55)	24.4(0.96)	11.1(0.44)	25.0(0.98)	27.0(1.06)	25.0(0.98)
16	M20 x 1.5	-CM-ML16-MRS20	48.0(1.89)	14.0(0.55)	24.4(0.96)	12.0(0.47)	25.0(0.98)	25.0(0.98)	25.0(0.98)
18	M20 x 1.5	-CM-ML18-MRS20	48.5(1.91)	14.0(0.55)	24.4(0.96)	12.0(0.47)	30.0(1.18)	27.0(1.06)	25.0(0.98)
20	M20 x 1.5	-CM-ML20-MRS20	50.0(1.97)	14.0(0.55)	26.0(1.02)	12.0(0.47)	32.0(1.26)	30.0(1.18)	25.0(0.98)
22	M24 x 1.5	-CM-ML22-MRS24	50.5(1.99)	14.0(0.55)	26.0(1.02)	15.0(0.59)	32.0(1.26)	30.0(1.18)	28.8(1.13)
25	M27 x 2	-CM-ML25-MRS27	57.5(2.26)	16.0(0.63)	31.3(1.23)	16.8(0.66)	38.0(1.50)	35.0(1.38)	32.0(1.26)

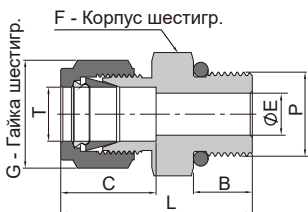

Совместим с прямой внутренней резьбой ISO 6149-1.

Метрическая трубка			Метрическая резьба (MST)					
D нар. трубки T (мм)	P-размер метрической резьбы	Артикул	Размеры, мм (дюймы)					
			L	B	C	E	G	F
6	M14 x 1.5	-CM-ML6-MST14	38.7(1.52)	11.0(0.43)	15.3(0.60)	4.8(0.19)	14.0(0.55)	19.0(0.75)
10	M14 x 1.5	-CM-ML10-MST14	40.0(1.57)	11.0(0.43)	17.2(0.68)	7.5(0.30)	19.0(0.75)	19.0(0.75)
10	M20 x 1.5	-CM-ML10-MST20	47.2(1.86)	14.0(0.55)	17.2(0.68)	7.9(0.31)	19.0(0.75)	27.0(1.06)
12	M14 x 1.5	-CM-ML12-MST14	40.2(1.58)	11.0(0.43)	22.8(0.90)	7.5(0.30)	22.0(0.87)	22.0(0.87)
12	M20 x 1.5	-CM-ML12-MST20	47.2(1.86)	14.0(0.55)	22.8(0.90)	9.5(0.37)	22.0(0.87)	27.0(1.06)

Штуцер с наружной резьбой

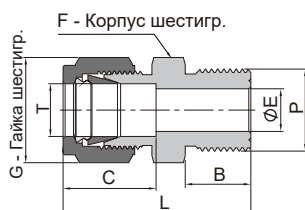

Метрическая трубка			Метрическая резьба (MS)					
D нар. трубки T (мм)	P-размер метрической резьбы	Артикул	Размеры, мм (дюймы)					
			L	B	C	E	G	F
6	M6 x 1	-CM-ML6-MS6	32.4(1.28)	8.0(0.31)	15.3(0.60)	2.0(0.08)	14.0(0.55)	14.0(0.55)
6	M8 x 1	-CM-ML6-MS8	35.3(1.39)	9.0(0.35)	15.3(0.60)	3.0(0.12)	14.0(0.55)	14.0(0.55)
6	M10 x 1	-CM-ML6-MS10	34.7(1.37)	11.0(0.43)	15.3(0.60)	4.7(0.19)	14.0(0.55)	14.0(0.55)
6	M12 x 1.5	-CM-ML6-MS12	36.4(1.43)	12.0(0.47)	15.3(0.60)	4.8(0.19)	14.0(0.55)	14.0(0.55)
6	M14 x 1.5	-CM-ML6-MS14	36.5(1.44)	13.0(0.51)	15.3(0.60)	4.8(0.19)	14.0(0.55)	16.0(0.63)
6	M16 x 1.5	-CM-ML6-MS16	38.4(1.51)	14.0(0.55)	15.3(0.60)	4.8(0.19)	14.0(0.55)	18.0(0.71)
6	M18 x 1.5	-CM-ML6-MS18	40.0(1.57)	15.0(0.59)	15.3(0.60)	4.8(0.19)	14.0(0.55)	19.0(0.75)
6	M20 x 1.5	-CM-ML6-MS20	41.7(1.64)	16.0(0.63)	15.3(0.60)	4.8(0.19)	14.0(0.55)	22.0(0.87)
8	M8 x 1	-CM-ML8-MS8	34.5(1.36)	9.0(0.35)	16.2(0.64)	3.0(0.12)	16.0(0.63)	14.0(0.55)
8	M10 x 1	-CM-ML8-MS10	36.6(1.44)	11.0(0.43)	16.2(0.64)	4.7(0.19)	16.0(0.63)	14.0(0.55)
8	M12 x 1.5	-CM-ML8-MS12	36.6(1.44)	12.0(0.47)	16.2(0.64)	6.0(0.24)	16.0(0.63)	14.0(0.55)
8	M14 x 1.5	-CM-ML8-MS14	37.7(1.48)	13.0(0.51)	16.2(0.64)	6.4(0.25)	16.0(0.63)	16.0(0.63)
8	M20 x 1.5	-CM-ML8-MS20	42.5(1.67)	16.0(0.63)	16.2(0.64)	6.4(0.25)	16.0(0.63)	22.0(0.87)
10	M12 x 1.5	-CM-ML10-MS12	38.7(1.52)	12.0(0.47)	17.2(0.68)	6.0(0.24)	19.0(0.75)	18.0(0.71)
10	M14 x 1.5	-CM-ML10-MS14	39.7(1.56)	13.0(0.51)	17.2(0.68)	7.2(0.28)	19.0(0.75)	18.0(0.71)
10	M20 x 1.5	-CM-ML10-MS20	43.5(1.71)	16.0(0.63)	17.2(0.68)	7.9(0.31)	19.0(0.75)	22.0(0.87)
12	M12 x 1.5	-CM-ML12-MS12	41.2(1.62)	12.0(0.47)	22.8(0.90)	6.0(0.24)	22.0(0.87)	22.0(0.87)
12	M16 x 1.5	-CM-ML12-MS16	43.2(1.70)	14.0(0.55)	22.8(0.90)	8.4(0.33)	22.0(0.87)	22.0(0.87)
12	M18 x 1.5	-CM-ML12-MS18	44.2(1.74)	15.0(0.59)	22.8(0.90)	9.5(0.37)	22.0(0.87)	22.0(0.87)
12	M20 x 1.5	-CM-ML12-MS20	45.2(1.78)	16.0(0.63)	22.8(0.90)	9.5(0.37)	22.0(0.87)	22.0(0.87)
14	M14 x 1.5	-CM-ML14-MS14	42.5(1.67)	13.0(0.51)	24.4(0.96)	7.2(0.28)	25.0(0.98)	24.0(0.94)
14	M16 x 1.5	-CM-ML14-MS16	43.9(1.73)	14.0(0.55)	24.4(0.96)	8.4(0.33)	25.0(0.98)	24.0(0.94)
14	M20 x 1.5	-CM-ML14-MS20	45.1(1.78)	16.0(0.63)	24.4(0.96)	10.8(0.43)	25.0(0.98)	24.0(0.94)
16	M20 x 1.5	-CM-ML16-MS20	46.1(1.81)	16.0(0.63)	24.4(0.96)	10.8(0.43)	25.0(0.98)	24.0(0.94)
18	M20 x 1.5	-CM-ML18-MS20	47.5(1.87)	16.0(0.63)	24.4(0.96)	10.8(0.43)	30.0(1.18)	27.0(1.06)
18	M22 x 1.5	-CM-ML18-MS22	48.5(1.91)	17.0(0.67)	24.4(0.96)	12.0(0.47)	30.0(1.18)	27.0(1.06)
20	M20 x 1.5	-CM-ML20-MS20	49.5(1.95)	16.0(0.63)	26.0(1.02)	10.8(0.43)	32.0(1.26)	30.0(1.18)
22	M24 x 1.5	-CM-ML22-MS24	50.5(1.99)	17.0(0.67)	26.0(1.02)	14.4(0.57)	32.0(1.26)	30.0(1.18)
25	M27 x 2	-CM-ML25-MS27	57.0(2.24)	18.0(0.71)	31.3(1.23)	16.1(0.63)	38.0(1.50)	35.0(1.38)

Штуцер с монтажной гайкой и наружной резьбой

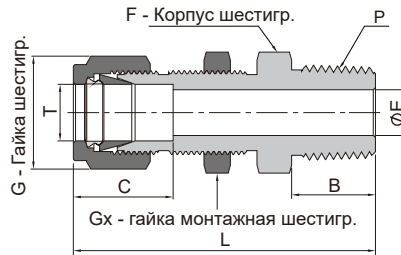

Дюймовая трубка			Размеры, мм (дюймы)									Резьба NPT	
D нар. трубки T (дюймы)	Размер P-NPT	Артикул	L	B	C	E	G	F	Gx	Размер отверстия панели, мм (дюймы)	Макс. толщина панели, мм (дюймы)		
			1/16	1/16	-BCM-FL1-NS1	30.2(1.19)	9.7(0.38)	8.6(0.34)	1.3(0.05)			7.9(0.31)	7.9(0.31)
1/16	1/8	-BCM-FL1-NS2	32.3(1.27)	9.7(0.38)	8.6(0.34)	1.3(0.05)	7.9(0.31)	11.1(0.44)	7.9(0.31)	5.2(0.20)	6.4(0.25)		
1/8	1/8	-BCM-FL2-NS2	46.5(1.83)	9.7(0.38)	12.7(0.50)	2.3(0.09)	11.1(0.44)	12.7(0.50)	12.7(0.50)	8.3(0.33)	12.7(0.50)		
3/16	1/8	-BCM-FL3-NS2	48.0(1.89)	9.7(0.38)	13.7(0.54)	3.0(0.12)	12.7(0.50)	14.3(0.56)	14.3(0.56)	9.9(0.39)	12.7(0.50)		
1/4	1/8	-BCM-FL4-NS2	49.5(1.95)	9.7(0.38)	15.2(0.60)	4.8(0.19)	14.3(0.56)	15.9(0.63)	15.9(0.63)	11.5(0.45)	10.2(0.40)		
1/4	1/4	-BCM-FL4-NS4	54.1(2.13)	14.2(0.56)	15.2(0.60)	4.8(0.19)	14.3(0.56)	15.9(0.63)	15.9(0.63)	11.5(0.45)	10.2(0.40)		
1/4	3/8	-BCM-FL4-NS6	54.9(2.16)	14.2(0.56)	15.2(0.60)	4.8(0.19)	15.9(0.63)	17.5(0.69)	15.9(0.63)	11.5(0.45)	10.2(0.40)		
1/4	1/2	-BCM-FL4-NS8	60.3(2.37)	19.1(0.75)	15.2(0.60)	4.8(0.19)	14.3(0.56)	22.2(0.87)	15.9(0.63)	11.5(0.45)	10.2(0.40)		
5/16	1/8	-BCM-FL5-NS2	52.8(2.08)	9.7(0.38)	16.3(0.64)	4.8(0.19)	15.9(0.63)	17.5(0.69)	17.5(0.69)	13.1(0.52)	11.2(0.44)		
5/16	1/4	-BCM-FL5-NS4	57.7(2.27)	14.2(0.56)	16.3(0.64)	6.4(0.25)	15.9(0.63)	17.5(0.69)	17.5(0.69)	13.1(0.52)	11.2(0.44)		
3/8	1/8	-BCM-FL6-NS2	52.9(2.08)	9.7(0.38)	16.8(0.66)	4.8(0.19)	17.5(0.69)	19.1(0.75)	19.1(0.75)	14.7(0.58)	11.2(0.44)		
3/8	1/4	-BCM-FL6-NS4	57.4(2.26)	14.2(0.56)	16.8(0.66)	7.1(0.28)	17.5(0.69)	19.1(0.75)	19.1(0.75)	14.7(0.58)	11.2(0.44)		
3/8	3/8	-BCM-FL6-NS6	57.4(2.26)	14.2(0.56)	16.8(0.66)	7.1(0.28)	17.5(0.69)	19.1(0.75)	19.1(0.75)	14.7(0.58)	11.2(0.44)		
3/8	1/2	-BCM-FL6-NS8	63.8(2.51)	19.1(0.75)	16.8(0.66)	7.1(0.28)	17.5(0.69)	22.2(0.87)	22.2(0.87)	14.7(0.58)	11.2(0.44)		
1/2	1/8	-BCM-FL8-NS2	58.7(2.31)	9.7(0.38)	22.9(0.90)	4.8(0.19)	22.2(0.87)	23.8(0.94)	23.8(0.94)	19.4(0.76)	12.7(0.50)		
1/2	1/4	-BCM-FL8-NS4	63.2(2.49)	14.2(0.56)	22.9(0.90)	7.1(0.28)	22.2(0.87)	23.8(0.94)	23.8(0.94)	19.4(0.76)	12.7(0.50)		
1/2	3/8	-BCM-FL8-NS6	63.2(2.49)	14.2(0.56)	22.9(0.90)	9.7(0.38)	22.2(0.87)	23.8(0.94)	22.2(0.87)	19.4(0.76)	12.7(0.50)		
1/2	1/2	-BCM-FL8-NS8	68.8(2.71)	19.1(0.75)	22.9(0.90)	10.4(0.41)	22.2(0.87)	23.8(0.94)	23.8(0.94)	19.4(0.76)	12.7(0.50)		
5/8	3/8	-BCM-FL10-NS6	66.7(2.63)	14.2(0.56)	24.4(0.96)	9.7(0.38)	25.4(1.00)	27.0(1.06)	27.0(1.06)	22.6(0.89)	15.1(0.59)		
5/8	1/2	-BCM-FL10-NS8	71.5(2.81)	19.1(0.75)	24.4(0.96)	11.9(0.47)	25.4(1.00)	27.0(1.06)	27.0(1.06)	22.6(0.89)	15.1(0.59)		
3/4	1/2	-BCM-FL12-NS8	76.2(3.00)	19.1(0.75)	24.4(0.96)	11.9(0.47)	28.6(1.13)	30.2(1.19)	30.2(1.19)	25.8(1.02)	16.8(0.66)		
3/4	3/4	-BCM-FL12-NS12	76.2(3.00)	19.1(0.75)	24.4(0.96)	15.7(0.62)	28.6(1.13)	30.2(1.19)	30.2(1.19)	25.8(1.02)	16.8(0.66)		
7/8	3/4	-BCM-FL14-NS12	84.1(3.31)	19.1(0.75)	25.9(1.02)	15.7(0.62)	31.8(1.25)	33.3(1.31)	33.3(1.31)	29.0(1.14)	19.1(0.75)		
1	3/4	-BCM-FL16-NS12	88.4(3.48)	19.1(0.75)	31.2(1.23)	15.7(0.62)	38.1(1.50)	41.3(1.63)	41.3(1.63)	33.7(1.33)	19.1(0.75)		
1	1	-BCM-FL16-NS16	93.2(3.67)	23.9(0.94)	31.2(1.23)	22.4(0.88)	38.1(1.50)	41.3(1.63)	41.3(1.63)	33.7(1.33)	19.1(0.75)		

Метрическая трубка			Размеры, мм (дюймы)									Резьба NPT	
D нар. трубки T (мм)	Размер P-NPT	Артикул	L	B	C	E	G	F	Gx	Размер отверстия панели, мм (дюймы)	Макс. толщина панели, мм (дюймы)		
			6	1/8	-BCM-ML6-NS2	49.6(1.95)	9.7(0.38)	15.3(0.60)	4.8(0.19)			14.0(0.55)	16.0(0.63)
6	1/4	-BCM-ML6-NS4	53.6(2.11)	14.2(0.56)	15.3(0.60)	4.8(0.19)	14.0(0.55)	16.0(0.63)	16.0(0.63)	11.5(0.45)	10.2(0.40)		
8	1/8	-BCM-ML8-NS2	52.3(2.06)	9.7(0.38)	16.2(0.64)	4.8(0.19)	16.0(0.63)	18.0(0.71)	18.0(0.71)	13.1(0.52)	11.2(0.44)		
8	1/4	-BCM-ML8-NS4	56.6(2.23)	14.2(0.56)	16.2(0.64)	6.4(0.25)	16.0(0.63)	18.0(0.71)	18.0(0.71)	13.1(0.52)	11.2(0.44)		
10	1/4	-BCM-ML10-NS4	58.4(2.30)	14.2(0.56)	17.2(0.68)	7.1(0.28)	19.0(0.75)	22.0(0.87)	22.0(0.87)	16.3(0.64)	11.2(0.44)		
10	3/8	-BCM-ML10-NS6	58.4(2.30)	14.2(0.56)	17.2(0.68)	7.9(0.31)	19.0(0.75)	22.0(0.87)	22.0(0.87)	16.3(0.64)	11.2(0.44)		
10	1/2	-BCM-ML10-NS8	63.1(2.48)	19.1(0.75)	17.2(0.68)	7.9(0.31)	19.0(0.75)	22.0(0.87)	22.0(0.87)	16.3(0.64)	11.2(0.44)		
12	1/4	-BCM-ML12-NS4	63.9(2.52)	14.2(0.56)	22.8(0.90)	7.1(0.28)	22.0(0.87)	24.0(0.94)	24.0(0.94)	19.5(0.77)	12.7(0.50)		
12	3/8	-BCM-ML12-NS6	63.9(2.52)	14.2(0.56)	22.8(0.90)	9.5(0.37)	22.0(0.87)	24.0(0.94)	24.0(0.94)	19.5(0.77)	12.7(0.50)		
12	1/2	-BCM-ML12-NS8	68.8(2.71)	19.1(0.75)	22.8(0.90)	9.5(0.37)	22.0(0.87)	24.0(0.94)	24.0(0.94)	19.5(0.77)	12.7(0.50)		

Штуцер с монтажной гайкой и наружной резьбой

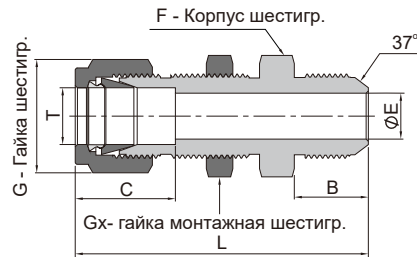

Дюймовая трубка			Развальцовка, конус 37° (AN)								
D нар. трубки T (дюймы)	Размер раструба трубки AN	Артикул	Размеры, мм (дюймы)							Размер отверстия панели, мм (дюймы)	Макс. толщина панели, мм (дюймы)
			L	B	C	E	G	F	Gx		
1/8	1/8	-BCM-FL2-AN2	48.5(1.91)	11.4(0.45)	12.7(0.50)	1.5(0.06)	11.1(0.44)	12.7(0.50)	12.7(0.50)	8.3(0.33)	12.7(0.50)
1/8	1/4	-BCM-FL2-AN4	51.8(2.04)	14.0(0.55)	12.7(0.50)	2.3(0.09)	11.1(0.44)	15.9(0.63)	12.7(0.50)	8.3(0.33)	12.7(0.50)
3/16	3/16	-BCM-FL3-AN3	50.3(1.98)	12.2(0.48)	13.7(0.54)	3.0(0.12)	12.7(0.50)	14.3(0.56)	14.3(0.56)	9.9(0.39)	12.7(0.50)
1/4	1/4	-BCM-FL4-AN4	53.8(2.12)	14.0(0.55)	15.2(0.60)	4.3(0.17)	14.3(0.56)	15.9(0.63)	15.9(0.63)	11.5(0.45)	10.2(0.40)
5/16	5/16	-BCM-FL5-AN5	56.1(2.21)	14.0(0.55)	16.2(0.64)	5.8(0.23)	15.9(0.63)	17.5(0.69)	17.5(0.69)	13.1(0.52)	14.3(0.56)
3/8	1/4	-BCM-FL6-AN4	57.2(2.25)	14.0(0.55)	16.8(0.66)	4.3(0.17)	17.5(0.69)	19.1(0.75)	19.1(0.75)	14.7(0.58)	11.2(0.44)
3/8	3/8	-BCM-FL6-AN6	57.2(2.25)	14.2(0.56)	16.8(0.66)	7.1(0.28)	17.5(0.69)	19.1(0.75)	19.1(0.75)	14.7(0.58)	11.2(0.44)
1/2	1/2	-BCM-FL8-AN8	65.8(2.59)	16.8(0.66)	22.8(0.90)	9.9(0.39)	22.2(0.87)	23.8(0.94)	23.8(0.94)	19.4(0.76)	12.7(0.50)
5/8	5/8	-BCM-FL10-AN10	69.6(2.74)	19.3(0.76)	24.4(0.96)	12.3(0.48)	25.4(1.00)	27.0(1.06)	27.0(1.06)	22.6(0.89)	15.1(0.59)
3/4	3/4	-BCM-FL12-AN12	79.0(3.11)	21.8(0.86)	24.4(0.96)	15.5(0.61)	28.6(1.13)	30.2(1.19)	30.2(1.19)	25.8(1.02)	16.8(0.66)
1	1	-BCM-FL16-AN16	92.5(3.64)	23.1(0.91)	31.2(1.23)	21.3(0.84)	38.1(1.50)	41.3(1.63)	41.3(1.63)	33.7(1.33)	19.1(0.75)

Штуцер для установки терморпары

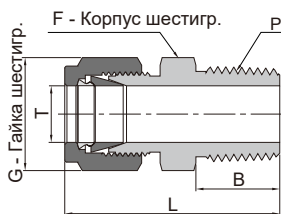

Дюймовая трубка			Резьба NPT			
D нар. трубки T (дюймы)	Размер P-NPT	Артикул	Размеры, мм (дюймы)			
			L	B	G	F
1/16	1/16	-TCM-FL1-NS1	23.9(0.94)	9.7(0.38)	7.9(0.31)	7.9(0.31)
1/16	1/8	-TCM-FL1-NS2	26.2(1.03)	9.7(0.38)	7.9(0.31)	11.1(0.44)
1/16	1/4	-TCM-FL1-NS4	31.0(1.22)	14.2(0.56)	7.9(0.31)	14.3(0.56)
1/8	1/16	-TCM-FL2-NS1	29.7(1.17)	9.7(0.38)	11.1(0.44)	11.1(0.44)
1/8	1/8	-TCM-FL2-NS2	30.5(1.20)	9.7(0.38)	11.1(0.44)	11.1(0.44)
1/8	1/4	-TCM-FL2-NS4	35.6(1.40)	14.2(0.56)	11.1(0.44)	14.3(0.56)
3/16	1/8	-TCM-FL3-NS2	31.2(1.23)	9.7(0.38)	12.7(0.50)	11.1(0.44)
3/16	1/4	-TCM-FL3-NS4	36.3(1.43)	14.2(0.56)	12.7(0.50)	14.3(0.56)
1/4	1/8	-TCM-FL4-NS2	32.8(1.29)	9.7(0.38)	14.3(0.56)	12.7(0.50)
1/4	1/4	-TCM-FL4-NS4	37.8(1.49)	14.2(0.56)	14.3(0.56)	14.3(0.56)
1/4	3/8	-TCM-FL4-NS6	38.4(1.51)	14.2(0.56)	14.3(0.56)	17.5(0.69)
1/4	1/2	-TCM-FL4-NS8	44.7(1.76)	19.1(0.75)	14.3(0.56)	22.2(0.87)
5/16	1/4	-TCM-FL5-NS4	38.6(1.52)	14.2(0.56)	15.9(0.63)	14.3(0.56)
3/8	1/4	-TCM-FL6-NS4	39.9(1.57)	14.2(0.56)	17.5(0.69)	15.9(0.63)
3/8	3/8	-TCM-FL6-NS6	39.9(1.57)	14.2(0.56)	17.5(0.69)	17.5(0.69)
3/8	1/2	-TCM-FL6-NS8	46.2(1.82)	19.1(0.75)	17.5(0.69)	22.2(0.87)
3/8	3/4	-TCM-FL6-NS12	47.8(1.88)	19.1(0.75)	17.5(0.69)	27.0(1.06)
1/2	1/2	-TCM-FL8-NS8	49.0(1.93)	19.1(0.75)	22.2(0.87)	22.2(0.87)
1/2	3/4	-TCM-FL8-NS12	50.5(1.99)	19.1(0.75)	22.2(0.87)	27.0(1.06)
5/8	3/4	-TCM-FL10-NS12	50.5(1.99)	19.1(0.75)	25.4(1.00)	27.0(1.06)
3/4	3/4	-TCM-FL12-NS12	50.5(1.99)	19.1(0.75)	28.6(1.13)	27.0(1.06)
1	1	-TCM-FL16-NS16	62.2(2.45)	23.9(0.94)	38.1(1.50)	34.9(1.37)

Штуцер для установки термопары

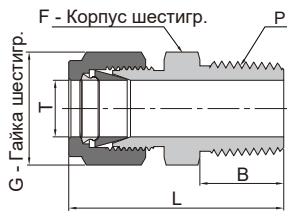

Метрическая трубка			Резьба NPT			
D нар. трубки T (мм)	Размер P-NPT	Артикул	Размеры, мм (дюймы)			
			L	B	G	F
2	1/8	-TCM-ML2-NS2	30.5(1.20)	9.7(0.38)	12.0(0.47)	12.0(0.47)
3	1/8	-TCM-ML3-NS2	30.5(1.20)	9.7(0.38)	12.0(0.47)	12.0(0.47)
3	1/4	-TCM-ML3-NS4	35.6(1.40)	14.2(0.56)	12.0(0.47)	14.0(0.55)
4	1/8	-TCM-ML4-NS2	31.2(1.23)	9.7(0.38)	12.0(0.47)	12.0(0.47)
4	1/4	-TCM-ML4-NS4	36.3(1.43)	14.2(0.56)	12.0(0.47)	14.0(0.55)
6	1/8	-TCM-ML6-NS2	32.8(1.29)	9.7(0.38)	14.0(0.55)	14.0(0.55)
6	1/4	-TCM-ML6-NS4	37.9(1.49)	14.2(0.56)	14.0(0.55)	14.0(0.55)
6	3/8	-TCM-ML6-NS6	38.4(1.51)	14.2(0.56)	14.0(0.55)	18.0(0.71)
6	1/2	-TCM-ML6-NS8	44.7(1.76)	19.1(0.75)	14.0(0.55)	22.0(0.87)
8	1/4	-TCM-ML8-NS4	38.7(1.52)	14.2(0.56)	16.0(0.63)	15.0(0.59)
8	3/8	-TCM-ML8-NS6	39.3(1.55)	14.2(0.56)	16.0(0.63)	18.0(0.71)
8	1/2	-TCM-ML8-NS8	45.6(1.80)	19.1(0.75)	16.0(0.63)	22.0(0.87)
10	3/8	-TCM-ML10-NS6	40.9(1.61)	14.2(0.56)	19.0(0.75)	18.0(0.71)
10	1/2	-TCM-ML10-NS8	46.5(1.83)	19.1(0.75)	19.0(0.75)	22.0(0.87)
10	3/4	-TCM-ML10-NS12	48.0(1.89)	19.1(0.75)	19.0(0.75)	27.0(1.06)
10	1	-TCM-ML10-NS16	54.6(2.15)	23.9(0.94)	19.0(0.75)	35.0(1.38)
12	3/8	-TCM-ML12-NS6	43.4(1.71)	14.2(0.56)	22.0(0.87)	22.0(0.87)
12	1/2	-TCM-ML12-NS8	49.0(1.93)	19.1(0.75)	22.0(0.87)	22.0(0.87)
12	3/4	-TCM-ML12-NS12	50.5(1.99)	19.1(0.75)	22.0(0.87)	27.0(1.06)
14	1/2	-TCM-ML14-NS8	49.0(1.93)	19.1(0.75)	25.0(0.98)	24.0(0.94)
14	3/4	-TCM-ML14-NS12	50.5(1.99)	19.1(0.75)	25.0(0.98)	27.0(1.06)
15	3/4	-TCM-ML15-NS12	50.5(1.99)	19.1(0.75)	25.0(0.98)	27.0(1.06)
15	1	-TCM-ML15-NS16	57.1(2.25)	23.9(0.94)	25.0(0.98)	35.0(1.38)
18	3/4	-TCM-ML18-NS12	50.5(1.99)	19.1(0.75)	30.0(1.18)	27.0(1.06)
20	1	-TCM-ML20-NS16	57.1(2.25)	23.9(0.94)	32.0(1.26)	35.0(1.38)
22	1	-TCM-ML22-NS16	57.1(2.25)	23.9(0.94)	32.0(1.26)	35.0(1.38)

Хроматографические фитинги

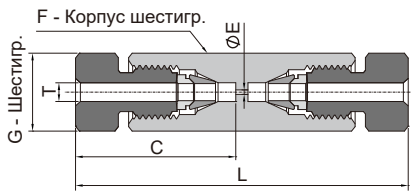

Дюймовая трубка		Размеры, мм (дюймы)					Мертвое пространство
D нар. трубки T (дюймы)	Артикул	L	C	E	G	F	
1/16	-U-NFL1	32.0(1.26)	15.5(0.61)	0.3(0.01)	6.4(0.25)	6.4(0.25)	$6.6 \times 10^{-5} \text{ см}^3$

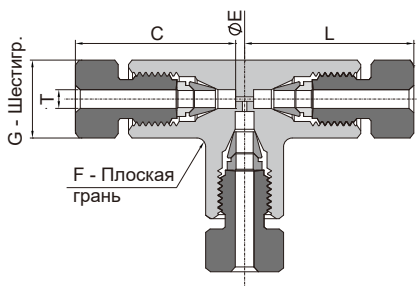

Дюймовая трубка		Размеры, мм (дюймы)					Мертвое пространство
D нар. трубки T (дюймы)	Артикул	L	C	E	G	F	
1/16	-TTT-NFL1	16.8(0.66)	15.5(0.61)	0.3(0.01)	6.4(0.25)	9.5(0.37)	$2.8 \times 10^{-4} \text{ см}^3$

Фитинги с колонками на торцах

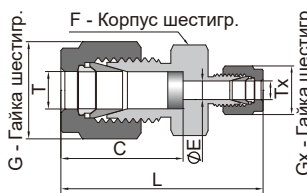
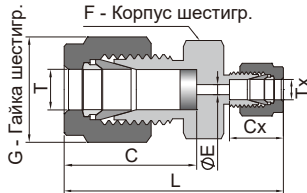
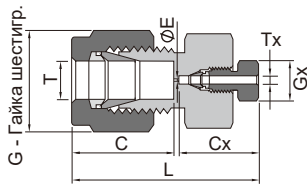

Дюймовая трубка

D нар. трубки T (дюймы)	D нар. трубки Tx (дюймы)	Артикул	Размеры, мм (дюймы)						Мертвое пространство
			L	C	Cx	E	G	Gx	
1/4	1/16	-U-FL4-NFL1	31.5(1.24)	15.2(0.60)	15.5(0.61)	0.3(0.01)	14.3(0.56)	6.4(0.25)	$6.8 \times 10^{-5} \text{ см}^3$
3/8	1/16	-U-FL6-NFL1	33.0(1.30)	16.8(0.66)	15.5(0.61)	0.3(0.01)	17.5(0.69)	6.4(0.25)	$6.8 \times 10^{-5} \text{ см}^3$

Дюймовая трубка

D нар. трубки T (дюймы)	D нар. трубки Tx (дюймы)	Артикул	Размеры, мм (дюймы)						Мертвое пространство
			L	C	Cx	G	F	E	
1/8	1/16	-U-TFL2SN7-FL1	31.0(1.22)	18.3(0.72)	8.6(0.34)	11.1(0.44)	11.1(0.44)	1.3(0.05)	$5.4 \times 10^{-3} \text{ см}^3$
1/4	1/16	-U-TFL4SN7-FL1	34.3(1.35)	20.8(0.82)	8.6(0.34)	14.3(0.56)	12.7(0.50)	1.3(0.05)	$6.7 \times 10^{-3} \text{ см}^3$
3/8	1/16	-U-TFL6SN7-FL1	36.6(1.44)	23.1(0.91)	8.6(0.34)	17.5(0.69)	15.9(0.63)	1.3(0.05)	$6.5 \times 10^{-3} \text{ см}^3$

Дюймовая трубка

D нар. трубки T (дюймы)	D нар. трубки Tx (дюймы)	Артикул	Размеры, мм (дюймы)						Мертвое пространство
			L	C	G	Gx	F	E	
1/8	1/16	-U-TFL2SN7-TFL1	31.0(1.22)	18.3(0.72)	11.1(0.44)	7.9(0.31)	11.1(0.44)	1.7(0.07)	0
1/4	1/16	-U-TFL4SN7-TFL1	34.3(1.35)	20.8(0.82)	14.3(0.56)	7.9(0.31)	12.7(0.50)	1.7(0.07)	0
3/8	1/16	-U-TFL6SN7-TFL1	36.6(1.44)	23.1(0.91)	17.5(0.69)	7.9(0.31)	15.9(0.63)	1.7(0.07)	0
1/2	1/16	-U-TFL6SN7-TFL1	40.1(1.58)	26.4(1.04)	22.2(0.87)	7.9(0.31)	20.6(0.81)	1.7(0.07)	0

Номинальный размер пор спеченного фильтрующего элемента из нержавеющей стали SN7 равен 7 мкм, имеются и другие номинальные размеры пор. Элементы из нержавеющей стали установлены неплотно для облегчения демонтажа и замены.

Штуцер с внутренней резьбой

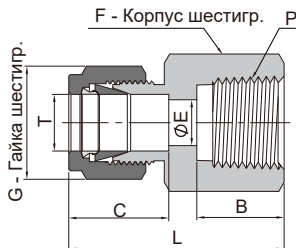

Дюймовая трубка

Резьба NPT

D нар. трубки T (дюймы)	Размер P-NPT	Артикул	Размеры, мм (дюймы)					
			L	B	C	E	G	F
1/16	1/16	-CF-FL1-NS1	23.6(0.93)	9.9(0.39)	8.6(0.34)	1.3(0.05)	7.9(0.31)	11.1(0.44)
1/16	1/8	-CF-FL1-NS2	24.4(0.96)	10.4(0.41)	8.6(0.34)	1.3(0.05)	7.9(0.31)	14.3(0.56)
1/8	1/8	-CF-FL2-NS2	28.7(1.13)	10.4(0.41)	12.7(0.50)	2.3(0.09)	11.1(0.44)	14.3(0.56)
1/8	1/4	-CF-FL2-NS4	33.5(1.32)	15.0(0.59)	12.7(0.50)	2.3(0.09)	11.1(0.44)	19.1(0.75)
3/16	1/8	-CF-FL3-NS2	29.7(1.17)	10.4(0.41)	13.7(0.54)	3.0(0.12)	12.7(0.50)	14.3(0.56)
1/4	1/8	-CF-FL4-NS2	31.2(1.23)	10.4(0.41)	15.2(0.60)	4.8(0.19)	14.3(0.56)	14.3(0.56)
1/4	1/4	-CF-FL4-NS4	35.8(1.41)	15.0(0.59)	15.2(0.60)	4.8(0.19)	14.3(0.56)	19.1(0.75)
1/4	3/8	-CF-FL4-NS6	37.6(1.48)	15.0(0.59)	15.2(0.60)	4.8(0.19)	14.3(0.56)	22.2(0.87)
1/4	1/2	-CF-FL4-NS8	42.4(1.67)	19.8(0.78)	15.2(0.60)	4.8(0.19)	14.3(0.56)	27.0(1.06)
5/16	1/8	-CF-FL5-NS2	32.0(1.26)	10.4(0.41)	16.3(0.64)	6.4(0.25)	15.9(0.63)	14.3(0.56)
5/16	1/4	-CF-FL5-NS4	36.8(1.45)	15.0(0.59)	16.3(0.64)	6.4(0.25)	15.9(0.63)	19.1(0.75)
3/8	1/8	-CF-FL6-NS2	32.8(1.29)	10.4(0.41)	16.8(0.66)	7.1(0.28)	17.5(0.69)	15.9(0.63)
3/8	1/4	-CF-FL6-NS4	37.6(1.48)	15.0(0.59)	16.8(0.66)	7.1(0.28)	17.5(0.69)	19.1(0.75)
3/8	3/8	-CF-FL6-NS6	39.1(1.54)	15.0(0.59)	16.8(0.66)	7.1(0.28)	17.5(0.69)	22.2(0.88)
3/8	1/2	-CF-FL6-NS8	43.9(1.73)	19.8(0.78)	16.8(0.66)	7.1(0.28)	17.5(0.69)	27.0(1.06)
3/8	3/4	-CF-FL6-NS12	47.8(1.88)	20.6(0.81)	16.8(0.66)	7.1(0.28)	17.5(0.69)	33.3(1.31)
1/2	1/4	-CF-FL8-NS4	40.4(1.59)	15.0(0.59)	22.9(0.90)	10.4(0.41)	22.2(0.87)	20.6(0.81)
1/2	3/8	-CF-FL8-NS6	41.9(1.65)	15.0(0.59)	22.9(0.90)	10.4(0.41)	22.2(0.87)	22.2(0.87)
1/2	1/2	-CF-FL8-NS8	46.7(1.84)	19.8(0.78)	22.9(0.90)	10.4(0.41)	22.2(0.87)	27.0(1.06)
1/2	3/4	-CF-FL8-NS12	48.3(1.90)	20.6(0.81)	22.9(0.90)	10.4(0.41)	22.2(0.87)	33.3(1.31)
5/8	3/8	-CF-FL10-NS6	41.9(1.65)	15.0(0.59)	24.4(0.96)	12.7(0.50)	25.4(1.00)	23.8(0.94)
5/8	1/2	-CF-FL10-NS8	46.7(1.84)	19.8(0.78)	24.4(0.96)	12.7(0.50)	25.4(1.00)	27.0(1.06)

Штуцер с внутренней резьбой

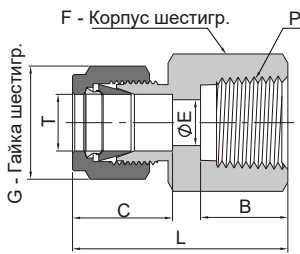

Дюймовая трубка			Резьба NPT					
D нар. трубки T (дюймы)	Размер P-NPT	Артикул	Размеры, мм (дюймы)					
			L	B	C	E	G	F
3/4	1/2	-CF-FL12-NS8	46.7(1.84)	19.8(0.78)	24.4(0.96)	15.7(0.62)	28.6(1.13)	27.0(1.06)
3/4	3/4	-CF-FL12-NS12	48.3(1.90)	20.6(0.81)	24.4(0.96)	15.7(0.62)	28.6(1.13)	33.3(1.31)
7/8	3/4	-CF-FL14-NS12	49.8(1.96)	20.6(0.81)	25.9(1.02)	18.3(0.72)	31.8(1.25)	33.3(1.31)
1	3/4	-CF-FL16-NS12	53.3(2.10)	20.6(0.81)	31.2(1.23)	22.4(0.88)	38.1(1.50)	34.9(1.37)
1	1	-CF-FL16-NS16	62.2(2.45)	25.4(1.00)	31.2(1.23)	22.4(0.88)	38.1(1.50)	41.3(1.63)
1 1/4	1 1/4	-CF-FL20-NS20	74.7(2.94)	25.4(1.00)	41.1(1.62)	27.7(1.09)	47.6(1.87)	54.0(2.13)
1 1/2	1 1/2	-CF-FL24-NS24	83.8(3.30)	27.7(1.09)	50.0(1.97)	34.0(1.34)	57.2(2.25)	60.3(2.37)

Дюймовая трубка			Коническая резьба ISO (RT)					
D нар. трубки T (дюймы)	Размер P-RT	Артикул	Размеры, мм (дюймы)					
			L	B	C	E	G	F
1/4	1/8	-CF-FL4-RT2	31.2(1.23)	10.4(0.41)	15.2(0.60)	4.8(0.19)	14.3(0.56)	14.3(0.56)
1/4	1/4	-CF-FL4-RT4	35.8(1.41)	15.0(0.59)	15.2(0.60)	4.8(0.19)	14.3(0.56)	19.1(0.75)
1/4	3/8	-CF-FL4-RT6	37.6(1.48)	15.0(0.59)	15.2(0.60)	4.8(0.19)	14.3(0.56)	22.2(0.87)
1/4	1/2	-CF-FL4-RT8	42.4(1.67)	19.8(0.78)	15.2(0.60)	4.8(0.19)	14.3(0.56)	27.0(1.06)
3/8	1/4	-CF-FL6-RT4	37.6(1.48)	15.0(0.59)	16.8(0.66)	7.1(0.28)	17.5(0.69)	19.1(0.75)
3/8	3/8	-CF-FL6-RT6	39.1(1.54)	15.0(0.59)	16.8(0.66)	7.1(0.28)	17.5(0.69)	22.2(0.87)
3/8	1/2	-CF-FL6-RT8	43.9(1.73)	19.8(0.78)	16.8(0.66)	7.1(0.28)	17.5(0.69)	27.0(1.06)
1/2	1/4	-CF-FL8-RT4	40.4(1.59)	15.0(0.59)	22.9(0.90)	10.4(0.41)	22.2(0.87)	20.6(0.81)
1/2	3/8	-CF-FL8-RT6	41.9(1.65)	15.0(0.59)	22.9(0.90)	10.4(0.41)	22.2(0.87)	22.2(0.87)
1/2	1/2	-CF-FL8-RT8	46.7(1.84)	19.8(0.78)	22.9(0.90)	10.4(0.41)	22.2(0.87)	27.0(1.06)

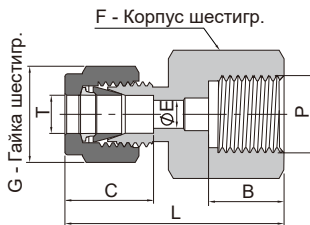

Дюймовая трубка			Цилиндрическая резьба ISO (RG)					
D нар. трубки T (дюймы)	Размер P-RG	Артикул	Размеры, мм (дюймы)					
			L	B	C	E	G	F
1/8	1/4	-CF-FL2-RG4	35.3(1.39)	12.9(0.51)	12.7(0.50)	2.3(0.09)	11.1(0.44)	19.1(0.75)
1/8	3/8	-CF-FL2-RG6	38.7(1.52)	14.2(0.56)	12.7(0.50)	2.3(0.09)	11.1(0.44)	23.8(0.94)
1/4	1/4	-CF-FL4-RG4	37.6(1.48)	12.9(0.51)	15.2(0.60)	4.8(0.19)	14.3(0.56)	19.1(0.75)
1/4	3/8	-CF-FL4-RG6	37.6(1.48)	14.2(0.56)	15.2(0.60)	4.8(0.19)	14.3(0.56)	23.8(0.94)
1/4	1/2	-CF-FL4-RG8	43.4(1.71)	18.8(0.74)	15.2(0.60)	4.8(0.19)	14.3(0.56)	27.0(1.06)
5/16	1/4	-CF-FL5-RG4	38.4(1.51)	12.9(0.51)	16.3(0.64)	5.6(0.22)	15.9(0.63)	19.1(0.75)
5/16	3/8	-CF-FL5-RG6	36.9(1.45)	14.2(0.56)	16.3(0.64)	6.4(0.25)	15.9(0.63)	23.8(0.94)
5/16	1/2	-CF-FL5-RG8	40.9(1.61)	18.8(0.74)	16.3(0.64)	7.1(0.28)	15.9(0.63)	27.0(1.06)
3/8	1/4	-CF-FL6-RG4	39.1(1.54)	12.9(0.51)	16.8(0.66)	5.6(0.22)	17.5(0.69)	19.1(0.75)
3/8	3/8	-CF-FL6-RG6	38.6(1.52)	14.2(0.56)	16.8(0.66)	6.4(0.25)	17.5(0.69)	23.8(0.94)
3/8	1/2	-CF-FL6-RG8	41.9(1.65)	18.8(0.74)	16.8(0.66)	7.1(0.28)	17.5(0.69)	27.0(1.06)
1/2	1/4	-CF-FL8-RG4	41.9(1.65)	12.9(0.51)	22.9(0.90)	5.6(0.22)	22.2(0.87)	22.2(0.87)
1/2	3/8	-CF-FL8-RG6	44.5(1.75)	14.2(0.56)	22.9(0.90)	6.4(0.25)	22.2(0.87)	23.8(0.94)
1/2	1/2	-CF-FL8-RG8	48.3(1.90)	18.8(0.74)	22.9(0.90)	7.1(0.28)	22.2(0.87)	27.0(1.06)

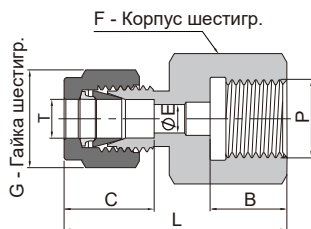

Переход к наружной резьбе в соответствии с японским стандартом для манометров

Дюймовая трубка			Цилиндрическая резьба по ISO (RJ)					
D нар. трубки T (дюймы)	Размер P-RJ	Артикул	Размеры, мм (дюймы)					
			L	B	C	E	G	F
1/4	1/4	-CF-FL4-RJ4	37.6(1.48)	12.9(0.51)	15.2(0.60)	4.6(0.18)	14.3(0.56)	19.1(0.75)
1/4	3/8	-CF-FL4-RJ6	37.6(1.48)	15.8(0.62)	15.2(0.60)	4.8(0.19)	14.3(0.56)	23.8(0.94)
1/4	1/2	-CF-FL4-RJ8	43.4(1.71)	18.8(0.74)	15.2(0.60)	4.8(0.19)	14.3(0.56)	27.0(1.06)
5/16	1/4	-CF-FL5-RJ4	38.4(1.51)	12.9(0.51)	16.3(0.64)	5.6(0.22)	15.9(0.63)	19.1(0.75)
5/16	1/2	-CF-FL5-RJ8	40.9(1.61)	18.8(0.74)	16.3(0.64)	7.1(0.28)	15.9(0.63)	27.0(1.06)
3/8	1/4	-CF-FL6-RJ4	39.1(1.54)	12.9(0.51)	16.8(0.66)	5.6(0.22)	17.5(0.69)	19.1(0.75)
3/8	3/8	-CF-FL6-RJ6	38.6(1.52)	15.8(0.62)	16.8(0.66)	6.4(0.25)	17.5(0.69)	23.8(0.94)
3/8	1/2	-CF-FL6-RJ8	41.9(1.65)	18.8(0.74)	16.8(0.66)	7.1(0.28)	17.5(0.69)	27.0(1.06)
1/2	1/4	-CF-FL8-RJ4	41.9(1.65)	12.9(0.51)	22.9(0.90)	5.6(0.22)	22.2(0.87)	20.6(0.81)
1/2	3/8	-CF-FL8-RJ6	44.5(1.75)	15.8(0.62)	22.9(0.90)	6.4(0.25)	22.2(0.87)	23.8(0.94)
1/2	1/2	-CF-FL8-RJ8	48.3(1.90)	18.8(0.74)	22.9(0.90)	7.1(0.28)	22.2(0.87)	27.0(1.06)

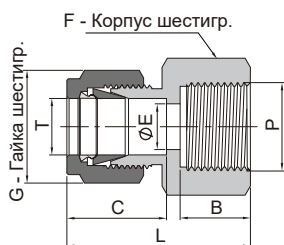

Дюймовая трубка			Метрическая резьба					
D нар. трубки T (дюймы)	P-размер метрической резьбы	Артикул	Размеры, мм (дюймы)					
			L	B	C	E	G	F
1/8	M14 x 1.5	-CF-FL2-MS14	31.0(1.22)	13.0(0.51)	12.7(0.50)	2.3(0.09)	11.1(0.44)	19.1(0.75)
1/8	M16 x 1.5	-CF-FL2-MS16	33.3(1.31)	14.0(0.55)	12.7(0.50)	2.3(0.09)	11.1(0.44)	22.2(0.87)
1/8	M18 x 1.5	-CF-FL2-MS18	34.3(1.35)	15.0(0.59)	12.7(0.50)	2.3(0.09)	11.1(0.44)	25.4(1.00)
1/8	M20 x 1.5	-CF-FL2-MS20	35.3(1.39)	16.0(0.63)	12.7(0.50)	2.3(0.09)	11.1(0.44)	27.0(1.06)
1/4	M16 x 1.5	-CF-FL4-MS16	35.8(1.41)	14.0(0.55)	15.2(0.60)	4.8(0.19)	14.3(0.56)	22.2(0.87)
1/4	M18 x 1.5	-CF-FL4-MS18	36.8(1.45)	15.0(0.59)	15.2(0.60)	4.8(0.19)	14.3(0.56)	25.4(1.00)
1/4	M20 x 1.5	-CF-FL4-MS20	37.8(1.49)	16.0(0.63)	15.2(0.60)	4.8(0.19)	14.3(0.56)	27.0(1.06)
3/8	M14 x 1.5	-CF-FL6-MS14	37.1(1.46)	13.0(0.51)	16.8(0.66)	7.1(0.28)	17.5(0.69)	19.1(0.75)
3/8	M16 x 1.5	-CF-FL6-MS16	37.5(1.48)	14.0(0.55)	16.8(0.66)	7.1(0.28)	17.5(0.69)	22.2(0.87)
3/8	M18 x 1.5	-CF-FL6-MS18	38.5(1.52)	15.0(0.59)	16.8(0.66)	7.1(0.28)	17.5(0.69)	25.4(1.00)
3/8	M20 x 1.5	-CF-FL6-MS20	39.5(1.56)	16.0(0.63)	16.8(0.66)	7.1(0.28)	17.5(0.69)	27.0(1.06)
1/2	M16 x 1.5	-CF-FL8-MS16	41.4(1.63)	14.0(0.55)	22.9(0.90)	8.4(0.33)	22.2(0.87)	22.2(0.87)
1/2	M18 x 1.5	-CF-FL8-MS18	42.4(1.67)	15.0(0.59)	22.9(0.90)	9.6(0.38)	22.2(0.87)	25.4(1.00)
1/2	M20 x 1.5	-CF-FL8-MS20	43.4(1.71)	16.0(0.63)	22.9(0.90)	10.4(0.41)	22.2(0.87)	27.0(1.06)
1/2	M22 x 1.5	-CF-FL8-MS22	41.9(1.65)	16.0(0.63)	22.9(0.90)	9.7(0.38)	22.2(0.87)	27.0(1.06)

Штуцер с внутренней резьбой

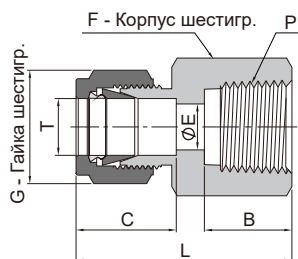

Метрическая трубка			Резьба NPT					
D нар. трубки T (мм)	Размер P-NPT	Артикул	Размеры, мм (дюймы)					
			L	B	C	E	G	F
3	1/8	-CF-ML3-NS2	28.7(1.13)	10.4(0.41)	12.9(0.51)	2.4(0.09)	12.0(0.47)	14.0(0.55)
3	1/4	-CF-ML3-NS4	33.5(1.32)	15.0(0.59)	12.9(0.51)	2.4(0.09)	12.0(0.47)	19.0(0.75)
4	1/8	-CF-ML4-NS2	29.7(1.17)	10.4(0.41)	13.7(0.54)	2.4(0.09)	12.0(0.47)	14.0(0.55)
6	1/8	-CF-ML6-NS2	31.3(1.23)	10.4(0.41)	15.3(0.60)	4.8(0.19)	14.0(0.55)	14.0(0.55)
6	1/4	-CF-ML6-NS4	35.8(1.41)	15.0(0.59)	15.3(0.60)	4.8(0.19)	14.0(0.55)	19.0(0.75)
6	3/8	-CF-ML6-NS6	37.7(1.48)	15.0(0.59)	15.3(0.60)	4.8(0.19)	14.0(0.55)	22.0(0.87)
6	1/2	-CF-ML6-NS8	42.5(1.67)	19.8(0.78)	15.3(0.60)	4.8(0.19)	14.0(0.55)	27.0(1.06)
8	1/8	-CF-ML8-NS2	32.1(1.26)	10.4(0.41)	16.2(0.64)	6.4(0.25)	16.0(0.63)	15.0(0.59)
8	1/4	-CF-ML8-NS4	37.0(1.46)	15.0(0.59)	16.2(0.64)	6.4(0.25)	16.0(0.63)	19.0(0.75)
8	3/8	-CF-ML8-NS6	38.5(1.52)	15.0(0.59)	16.2(0.64)	6.4(0.25)	16.0(0.63)	22.0(0.87)
8	1/2	-CF-ML8-NS8	43.3(1.70)	19.8(0.78)	16.2(0.64)	6.4(0.25)	16.0(0.63)	27.0(1.06)
10	1/8	-CF-ML10-NS2	33.0(1.30)	10.4(0.41)	17.2(0.68)	7.9(0.31)	19.0(0.75)	18.0(0.71)
10	1/4	-CF-ML10-NS4	37.8(1.49)	15.0(0.59)	17.2(0.68)	7.9(0.31)	19.0(0.75)	19.0(0.75)
10	3/8	-CF-ML10-NS6	39.4(1.55)	15.0(0.59)	17.2(0.68)	7.9(0.31)	19.0(0.75)	22.0(0.87)
10	1/2	-CF-ML10-NS8	44.2(1.74)	19.8(0.78)	17.2(0.68)	7.9(0.31)	19.0(0.75)	27.0(1.06)

Штуцер с внутренней резьбой

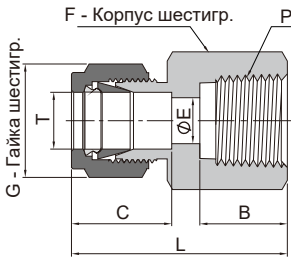

Метрическая трубка			Резьба NPT					
D нар. трубки T (мм)	Размер P-NPT	Артикул	Размеры, мм (дюймы)					
			L	B	C	E	G	F
12	1/4	-CF-ML12-NS4	40.3(1.59)	15.0(0.59)	22.8(0.90)	9.5(0.37)	22.0(0.87)	22.0(0.87)
12	3/8	-CF-ML12-NS6	41.9(1.65)	15.0(0.59)	22.8(0.90)	9.5(0.37)	22.0(0.87)	22.0(0.87)
12	1/2	-CF-ML12-NS8	46.7(1.84)	19.8(0.78)	22.8(0.90)	9.5(0.37)	22.0(0.87)	27.0(1.06)
12	3/4	-CF-ML12-NS12	49.1(1.93)	20.6(0.81)	22.8(0.90)	9.5(0.37)	22.0(0.87)	35.0(1.38)
14	3/4	-CF-ML14-NS12	49.7(1.96)	20.6(0.81)	24.4(0.96)	11.1(0.44)	25.0(0.98)	35.0(1.38)
15	1/2	-CF-ML15-NS8	46.7(1.84)	19.8(0.78)	24.4(0.96)	11.9(0.47)	25.0(0.98)	27.0(1.06)
16	3/8	-CF-ML16-NS6	41.9(1.65)	15.0(0.59)	24.4(0.96)	12.7(0.50)	25.0(0.98)	27.0(1.06)
16	1/2	-CF-ML16-NS8	46.9(1.85)	19.8(0.78)	24.4(0.96)	12.7(0.50)	25.0(0.98)	27.0(1.06)
20	1/2	-CF-ML20-NS8	47.9(1.89)	19.8(0.78)	26.0(1.02)	15.9(0.63)	32.0(1.26)	30.0(1.18)
20	3/4	-CF-ML20-NS12	49.7(1.96)	20.6(0.81)	26.0(1.02)	15.9(0.63)	32.0(1.26)	35.0(1.38)
22	3/4	-CF-ML22-NS12	49.7(1.96)	20.6(0.81)	26.0(1.02)	18.3(0.72)	32.0(1.26)	35.0(1.38)
22	1	-CF-ML22-NS16	57.9(2.28)	25.4(1.00)	26.0(1.02)	18.3(0.72)	32.0(1.26)	41.0(1.61)
25	3/4	-CF-ML25-NS12	53.4(2.10)	20.6(0.81)	31.3(1.23)	21.8(0.86)	38.0(1.50)	35.0(1.38)
25	1	-CF-ML25-NS16	62.3(2.45)	25.4(1.00)	31.3(1.23)	21.8(0.86)	38.0(1.50)	41.0(1.61)

Штуцер с внутренней резьбой

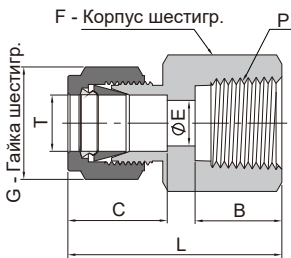

Метрическая трубка			Коническая резьба ISO (RT)					
D нар. трубки T (мм)	Размер P-RT	Артикул	Размеры, мм (дюймы)					
			L	B	C	E	G	F
3	1/8	-CF-ML3-RT2	28.7(1.13)	10.4(0.41)	12.9(0.51)	2.4(0.09)	12.0(0.47)	14.0(0.55)
6	1/8	-CF-ML6-RT2	31.3(1.23)	10.4(0.41)	15.3(0.60)	4.8(0.19)	14.0(0.55)	14.0(0.55)
6	1/4	-CF-ML6-RT4	35.8(1.41)	15.0(0.59)	15.3(0.60)	4.8(0.19)	14.0(0.55)	19.0(0.75)
6	3/8	-CF-ML6-RT6	37.9(1.49)	15.0(0.59)	15.3(0.60)	4.8(0.19)	14.0(0.55)	22.0(0.87)
6	1/2	-CF-ML6-RT8	42.5(1.67)	19.8(0.78)	15.3(0.60)	4.8(0.19)	14.0(0.55)	27.0(1.06)
8	1/8	-CF-ML8-RT2	32.1(1.26)	10.4(0.41)	16.2(0.64)	6.4(0.25)	16.0(0.63)	15.0(0.59)
8	1/4	-CF-ML8-RT4	37.0(1.46)	15.0(0.59)	16.2(0.64)	6.4(0.25)	16.0(0.63)	19.0(0.75)
8	3/8	-CF-ML8-RT6	38.5(1.52)	15.0(0.59)	16.2(0.64)	6.4(0.25)	16.0(0.63)	22.0(0.87)
8	1/2	-CF-ML8-RT8	43.3(1.70)	19.8(0.78)	16.2(0.64)	6.4(0.25)	16.0(0.63)	27.0(1.06)
10	1/8	-CF-ML10-RT2	33.0(1.30)	10.4(0.41)	17.2(0.68)	7.9(0.31)	19.0(0.75)	18.0(0.71)
10	1/4	-CF-ML10-RT4	37.8(1.49)	15.0(0.59)	17.2(0.68)	7.9(0.31)	19.0(0.75)	19.0(0.75)
10	3/8	-CF-ML10-RT6	39.4(1.55)	15.0(0.59)	17.2(0.68)	7.9(0.31)	19.0(0.75)	22.0(0.87)
10	1/2	-CF-ML10-RT8	44.2(1.74)	19.8(0.78)	17.2(0.68)	7.9(0.31)	19.0(0.75)	27.0(1.06)
12	1/8	-CF-ML12-RT2	35.5(1.40)	10.4(0.41)	22.8(0.90)	8.3(0.33)	22.0(0.87)	22.0(0.87)
12	1/4	-CF-ML12-RT4	40.3(1.59)	15.0(0.59)	22.8(0.90)	9.5(0.37)	22.0(0.87)	22.0(0.87)
12	3/8	-CF-ML12-RT6	41.9(1.65)	15.0(0.59)	22.8(0.90)	9.5(0.37)	22.0(0.87)	22.0(0.87)
12	1/2	-CF-ML12-RT8	46.7(1.84)	19.8(0.78)	22.8(0.90)	9.5(0.37)	22.0(0.87)	27.0(1.06)
12	3/4	-CF-ML12-RT12	49.0(1.93)	20.6(0.81)	22.8(0.90)	9.5(0.37)	22.0(0.87)	35.0(1.38)
15	1/2	-CF-ML15-RT8	46.7(1.84)	19.8(0.78)	24.4(0.96)	11.9(0.47)	25.0(0.98)	27.0(1.06)
16	1/2	-CF-ML16-RT8	48.4(1.91)	19.8(0.78)	24.4(0.96)	12.7(0.50)	25.0(0.98)	27.0(1.06)
16	3/4	-CF-ML16-RT12	49.7(1.96)	20.6(0.81)	24.4(0.96)	12.7(0.50)	25.0(0.98)	35.0(1.38)
20	1/2	-CF-ML20-RT8	47.9(1.89)	19.8(0.78)	26.0(1.02)	15.9(0.63)	32.0(1.26)	30.0(1.18)
20	3/4	-CF-ML20-RT12	49.7(1.96)	20.6(0.81)	26.0(1.02)	15.9(0.63)	32.0(1.26)	35.0(1.38)
22	3/4	-CF-ML22-RT12	49.7(1.96)	20.6(0.81)	26.0(1.02)	18.3(0.72)	32.0(1.26)	35.0(1.38)
22	1	-CF-ML22-RT16	57.9(2.28)	25.4(1.00)	26.0(1.02)	18.3(0.72)	32.0(1.26)	41.0(1.61)
25	3/4	-CF-ML25-RT12	53.4(2.10)	20.6(0.81)	31.3(1.23)	21.8(0.86)	38.0(1.50)	35.0(1.38)
25	1	-CF-ML25-RT16	62.3(2.45)	25.4(1.00)	31.3(1.23)	21.8(0.86)	38.0(1.50)	41.0(1.61)

Штуцер с внутренней резьбой

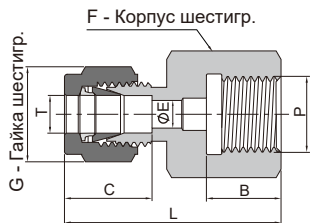
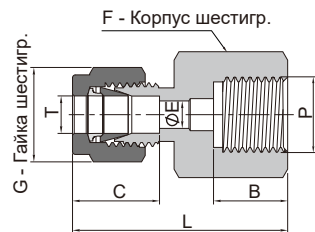
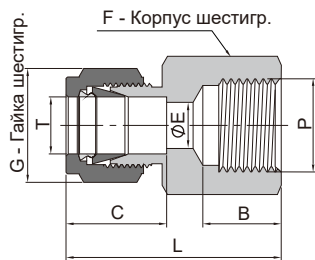

Переход к наружной резьбе
в соответствии с японским
стандартом для
манометров

Метрическая трубка			Цилиндрическая резьба ISO (RP)					
D нар. трубки T (мм)	Размер P-RP	Артикул	Размеры, мм (дюймы)					
			L	B	C	E	G	F
6	1/8	-CF-ML6-RP2	33.5(1.32)	15.5(0.61)	15.3(0.60)	4.8(0.19)	14.0(0.55)	14.0(0.55)
6	1/4	-CF-ML6-RP4	39.4(1.55)	15.5(0.61)	15.3(0.60)	4.8(0.19)	14.0(0.55)	19.0(0.75)
22	3/4	-CF-ML22-RP12	53.3(2.10)	20.5(0.81)	26.0(1.02)	18.3(0.72)	32.0(1.26)	35.0(1.38)
25	1	-CF-ML25-RP16	63.9(2.52)	23.5(0.93)	31.3(1.23)	21.8(0.86)	38.0(1.50)	40.0(1.57)

Метрическая трубка			Цилиндрическая резьба ISO (RG)					
D нар. трубки T (мм)	Размер P-RG	Артикул	Размеры, мм (дюймы)					
			L	B	C	E	G	F
3	1/4	-CF-ML3-RG4	35.3(1.39)	12.9(0.51)	12.9(0.51)	2.4(0.09)	12.0(0.47)	19.0(0.75)
6	1/4	-CF-ML6-RG4	37.6(1.48)	12.9(0.51)	15.3(0.60)	4.8(0.19)	14.0(0.55)	19.0(0.75)
6	3/8	-CF-ML6-RG6	37.6(1.48)	14.2(0.56)	15.3(0.60)	4.8(0.19)	14.0(0.55)	24.0(0.94)
6	1/2	-CF-ML6-RG8	43.5(1.71)	18.8(0.74)	15.3(0.60)	4.8(0.19)	14.0(0.55)	27.0(1.06)
8	1/4	-CF-ML8-RG4	38.5(1.52)	12.9(0.51)	16.2(0.64)	5.5(0.22)	16.0(0.63)	19.0(0.75)
8	3/8	-CF-ML8-RG6	36.2(1.43)	14.2(0.56)	16.2(0.64)	6.4(0.25)	16.0(0.63)	24.0(0.94)
8	1/2	-CF-ML8-RG8	41.0(1.61)	18.8(0.74)	16.2(0.64)	6.4(0.25)	16.0(0.63)	27.0(1.06)
10	1/4	-CF-ML10-RG4	39.4(1.55)	12.9(0.51)	17.2(0.68)	5.5(0.22)	19.0(0.75)	19.0(0.75)
10	3/8	-CF-ML10-RG6	38.8(1.53)	14.2(0.56)	17.2(0.68)	6.4(0.25)	19.0(0.75)	24.0(0.94)
10	1/2	-CF-ML10-RG8	42.1(1.66)	18.8(0.74)	17.2(0.68)	7.9(0.31)	19.0(0.75)	27.0(1.06)
12	1/4	-CF-ML12-RG4	41.9(1.65)	12.9(0.51)	22.8(0.90)	5.5(0.22)	22.0(0.87)	22.0(0.87)
12	3/8	-CF-ML12-RG6	44.4(1.75)	14.2(0.56)	22.8(0.90)	6.4(0.25)	22.0(0.87)	24.0(0.94)
12	1/2	-CF-ML12-RG8	48.2(1.90)	18.8(0.74)	22.8(0.90)	7.1(0.28)	22.0(0.87)	27.0(1.06)
20	1/2	-CF-ML20-RG8	54.3(2.14)	18.8(0.74)	26.0(1.02)	7.1(0.28)	32.0(1.26)	30.0(1.18)
22	1/2	-CF-ML22-RG8	54.3(2.14)	18.8(0.74)	26.0(1.02)	7.1(0.28)	32.0(1.26)	30.0(1.18)

Метрическая трубка			Цилиндрическая резьба ISO (RJ)					
D нар. трубки T (мм)	Размер P-RJ	Артикул	Размеры, мм (дюймы)					
			L	B	C	E	G	F
6	1/4	-CF-ML6-RJ4	37.6(1.48)	12.9(0.51)	15.3(0.60)	4.8(0.19)	14.0(0.55)	19.0(0.75)
6	3/8	-CF-ML6-RJ6	37.6(1.48)	15.8(0.62)	15.3(0.60)	4.8(0.19)	14.0(0.55)	24.0(0.94)
6	1/2	-CF-ML6-RJ8	43.5(1.71)	18.8(0.74)	15.3(0.60)	4.8(0.19)	14.0(0.55)	27.0(1.06)
8	1/4	-CF-ML8-RJ4	38.5(1.52)	12.9(0.51)	16.2(0.64)	5.5(0.22)	16.0(0.63)	19.0(0.75)
8	3/8	-CF-ML8-RJ6	36.2(1.43)	15.8(0.62)	16.2(0.64)	6.5(0.26)	16.0(0.63)	24.0(0.94)
8	1/2	-CF-ML8-RJ8	41.0(1.61)	18.8(0.74)	16.2(0.64)	7.0(0.28)	16.0(0.63)	27.0(1.06)
10	1/4	-CF-ML10-RJ4	39.4(1.55)	12.9(0.51)	17.2(0.68)	5.5(0.22)	19.0(0.75)	19.0(0.75)
10	3/8	-CF-ML10-RJ6	38.8(1.53)	15.8(0.62)	17.2(0.68)	6.5(0.26)	19.0(0.75)	24.0(0.94)
10	1/2	-CF-ML10-RJ8	42.1(1.66)	18.8(0.74)	17.2(0.68)	7.0(0.28)	19.0(0.75)	27.0(1.06)
12	1/4	-CF-ML12-RJ4	41.9(1.65)	12.9(0.51)	22.8(0.90)	5.5(0.22)	22.0(0.87)	22.0(0.87)
12	3/8	-CF-ML12-RJ6	44.4(1.75)	15.8(0.62)	22.8(0.90)	6.5(0.26)	22.0(0.87)	24.0(0.94)
12	1/2	-CF-ML12-RJ8	48.2(1.90)	18.8(0.74)	22.8(0.90)	7.0(0.28)	22.0(0.87)	27.0(1.06)

А-34 Обжимные фитинги серии 6D

Обжимные фитинги

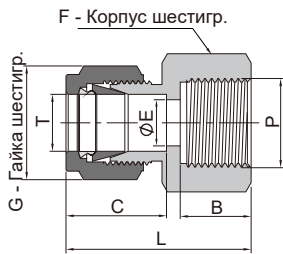

Метрическая трубка			Метрическая резьба (MS)						
D нар. трубки (мм)	P-размер метрической резьбы	Артикул	Размеры, мм (дюймы)						
			L	B	C	E	G	F	
6	M10 x 1	-CF-ML6-MS10	32.7(1.29)	11.0(0.43)	15.3(0.60)	4.7(0.19)	14.0(0.55)	16.0(0.63)	
6	M14 x 1.5	-CF-ML6-MS14	36.1(1.42)	13.0(0.51)	15.3(0.60)	4.8(0.19)	14.0(0.55)	19.0(0.75)	
6	M20 x 1.5	-CF-ML6-MS20	37.7(1.48)	16.0(0.63)	15.3(0.60)	4.8(0.19)	14.0(0.55)	27.0(1.06)	
8	M8 x 1	-CF-ML8-MS8	31.6(1.24)	9.0(0.35)	16.2(0.64)	3.0(0.12)	16.0(0.63)	14.0(0.55)	
8	M10 x 1	-CF-ML8-MS10	33.6(1.32)	11.0(0.43)	16.2(0.64)	4.0(0.16)	16.0(0.63)	16.0(0.63)	
8	M14 x 1.5	-CF-ML8-MS14	35.6(1.40)	13.0(0.51)	16.2(0.64)	6.4(0.25)	16.0(0.63)	19.0(0.75)	
8	M20 x 1.5	-CF-ML8-MS20	38.6(1.52)	16.0(0.63)	16.2(0.64)	6.4(0.25)	16.0(0.63)	27.0(1.06)	
10	M16 x 1.5	-CF-ML10-MS16	38.1(1.50)	14.0(0.55)	17.2(0.68)	7.9(0.31)	19.0(0.75)	22.0(0.87)	
12	M20 x 1.5	-CF-ML12-MS20	44.9(1.77)	16.0(0.63)	22.8(0.90)	9.5(0.37)	22.0(0.87)	27.0(1.06)	
14	M10 x 1	-CF-ML14-MS10	42.5(1.67)	11.0(0.43)	24.4(0.96)	4.0(0.16)	25.0(0.98)	24.0(0.94)	
14	M20 x 1.5	-CF-ML14-MS20	44.9(1.77)	16.0(0.63)	24.4(0.96)	10.8(0.43)	25.0(0.98)	27.0(1.06)	
14	M22 x 1.5	-CF-ML14-MS22	45.9(1.81)	17.0(0.67)	24.4(0.96)	11.1(0.44)	25.0(0.98)	27.0(1.06)	
16	M20 x 1.5	-CF-ML16-MS20	44.9(1.77)	16.0(0.63)	24.4(0.96)	10.8(0.43)	25.0(0.98)	27.0(1.06)	
20	M20 x 1.5	-CF-ML20-MS20	46.5(1.83)	16.0(0.63)	26.0(1.02)	10.8(0.43)	32.0(1.26)	30.0(1.18)	
25	M27 x 2	-CF-ML25-MS27	54.4(2.14)	18.0(0.71)	31.3(1.23)	16.1(0.63)	38.0(1.50)	35.0(1.38)	

Штуцер с монтажной гайкой и внутренней резьбой

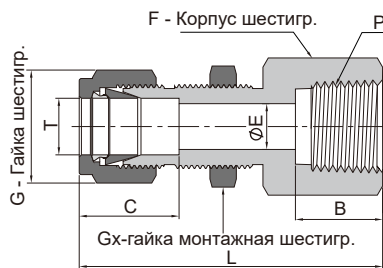

Дюймовая трубка			Резьба NPT									
D нар. трубки T (дюймы)	Размер P-NPT	Артикул	Размеры, мм (дюймы)							Размер отверстия панели, мм (дюймы)	Макс. толщина панели, мм (дюймы)	
			L	B	C	E	G	F	Gx			
1/16	1/16	-BCF-FL1-NS1	30.2(1.19)	9.9(0.39)	8.6(0.34)	1.3(0.05)	7.9(0.31)	11.1(0.44)	7.9(0.31)	5.2(0.20)	3.2(0.13)	
1/16	1/8	-BCF-FL1-NS2	30.7(1.20)	10.4(0.41)	8.6(0.34)	1.3(0.05)	7.9(0.31)	14.3(0.56)	7.9(0.31)	5.2(0.20)	3.2(0.13)	
1/8	1/8	-BCF-FL2-NS2	44.7(1.76)	10.4(0.41)	12.7(0.50)	2.3(0.09)	11.1(0.44)	14.3(0.56)	12.7(0.50)	8.3(0.33)	12.7(0.50)	
1/8	1/4	-BCF-FL2-NS4	49.6(1.95)	15.0(0.59)	12.7(0.50)	2.3(0.09)	11.1(0.44)	19.1(0.75)	12.7(0.50)	8.3(0.33)	12.7(0.50)	
3/16	1/8	-BCF-FL3-NS2	45.5(1.79)	10.4(0.41)	13.7(0.54)	3.0(0.12)	12.7(0.50)	14.3(0.56)	14.3(0.56)	9.9(0.39)	12.7(0.50)	
1/4	1/8	-BCF-FL4-NS2	47.0(1.85)	10.4(0.41)	15.2(0.60)	4.8(0.19)	14.3(0.56)	15.9(0.63)	15.9(0.63)	11.5(0.45)	10.2(0.40)	
1/4	1/4	-BCF-FL4-NS4	51.8(2.04)	15.0(0.59)	15.2(0.60)	4.8(0.19)	14.3(0.56)	19.1(0.75)	15.9(0.63)	11.5(0.45)	10.2(0.40)	
1/4	3/8	-BCF-FL4-NS6	53.3(2.10)	15.0(0.59)	15.2(0.60)	4.8(0.19)	14.3(0.56)	22.2(0.87)	15.9(0.63)	11.5(0.45)	10.2(0.40)	
1/4	1/2	-BCF-FL4-NS8	58.2(2.29)	19.8(0.78)	15.2(0.60)	4.8(0.19)	14.3(0.56)	27.0(1.06)	15.9(0.63)	11.5(0.45)	10.2(0.40)	
5/16	1/8	-BCF-FL5-NS2	49.8(1.96)	10.4(0.41)	16.3(0.64)	6.4(0.25)	15.9(0.63)	17.5(0.69)	17.5(0.69)	13.1(0.52)	11.2(0.44)	
5/16	1/4	-BCF-FL5-NS4	60.5(2.38)	15.0(0.59)	16.3(0.64)	6.4(0.25)	15.9(0.63)	19.1(0.75)	17.5(0.69)	13.1(0.52)	11.2(0.44)	
3/8	1/8	-BCF-FL6-NS2	50.3(1.98)	10.4(0.41)	16.8(0.66)	7.1(0.28)	17.5(0.69)	19.1(0.75)	19.1(0.75)	14.7(0.58)	11.2(0.44)	
3/8	1/4	-BCF-FL6-NS4	55.1(2.17)	15.0(0.59)	16.8(0.66)	7.1(0.28)	17.5(0.69)	19.1(0.75)	19.1(0.75)	14.7(0.58)	11.2(0.44)	
3/8	3/8	-BCF-FL6-NS6	56.6(2.23)	15.0(0.59)	16.8(0.66)	7.1(0.28)	17.5(0.69)	22.2(0.87)	19.1(0.75)	14.7(0.58)	11.2(0.44)	
3/8	1/2	-BCF-FL6-NS8	61.5(2.42)	19.8(0.78)	16.8(0.66)	7.1(0.28)	17.5(0.69)	27.0(1.06)	19.1(0.75)	14.7(0.58)	11.2(0.44)	
3/8	3/4	-BCF-FL6-NS12	65.3(2.57)	20.6(0.81)	16.8(0.66)	7.1(0.28)	17.5(0.69)	33.3(1.31)	19.1(0.75)	14.7(0.58)	11.2(0.44)	
1/2	1/4	-BCF-FL8-NS4	60.2(2.37)	15.0(0.59)	22.9(0.90)	10.4(0.41)	22.2(0.87)	23.8(0.94)	23.8(0.94)	19.4(0.76)	12.7(0.50)	
1/2	3/8	-BCF-FL8-NS6	61.7(2.43)	15.0(0.59)	22.9(0.90)	10.4(0.41)	22.2(0.87)	23.8(0.94)	23.8(0.94)	19.4(0.76)	12.7(0.50)	
1/2	1/2	-BCF-FL8-NS8	66.5(2.62)	19.8(0.78)	22.9(0.90)	10.4(0.41)	22.2(0.87)	27.0(1.06)	23.8(0.94)	19.4(0.76)	12.7(0.50)	
1/2	3/4	-BCF-FL8-NS12	68.1(2.68)	20.6(0.81)	22.9(0.90)	10.4(0.41)	22.2(0.87)	33.3(1.31)	23.8(0.94)	19.4(0.76)	12.7(0.50)	

Штуцер с монтажной гайкой и внутренней резьбой

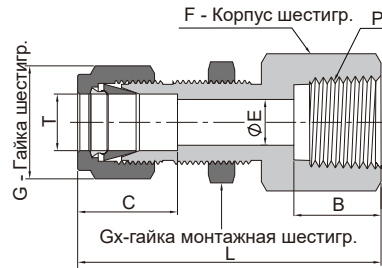

Дюймовая трубка			Резьба NPT									
D нар. трубки T (дюймы)	Размер P-NPT	Артикул	Размеры, мм (дюймы)							Размер отверстия панели, мм (дюймы)	Макс. толщина панели, мм (дюймы)	
			L	B	C	E	G	F	Gx			
5/8	3/8	-BCF-FL10-NS6	62.5(2.46)	15.0(0.59)	24.4(0.96)	12.7(0.50)	25.4(1.00)	27.0(1.06)	27.0(1.06)	22.6(0.89)	15.1(0.59)	
5/8	1/2	-BCF-FL10-NS8	67.3(2.65)	19.8(0.78)	24.4(0.96)	12.7(0.50)	25.4(1.00)	27.0(1.06)	27.0(1.06)	22.6(0.89)	15.1(0.59)	
3/4	1/2	-BCF-FL12-NS8	72.2(2.84)	19.8(0.78)	24.4(0.96)	15.7(0.62)	28.6(1.13)	30.2(1.19)	30.2(1.19)	25.8(1.02)	19.8(0.78)	
3/4	3/4	-BCF-FL12-NS12	73.7(2.90)	20.6(0.81)	24.4(0.96)	15.7(0.62)	28.6(1.13)	33.3(1.31)	30.2(1.19)	25.8(1.02)	19.8(0.78)	
7/8	3/4	-BCF-FL14-NS12	80.8(3.18)	20.6(0.81)	25.9(1.02)	18.3(0.72)	31.8(1.25)	33.3(1.31)	33.3(1.31)	29.0(1.14)	23.8(0.94)	
1	3/4	-BCF-FL16-NS12	84.7(3.33)	20.6(0.81)	31.2(1.23)	22.4(0.88)	38.1(1.50)	41.3(1.63)	41.3(1.63)	33.7(1.33)	23.8(0.94)	
1	1	-BCF-FL16-NS16	93.5(3.68)	25.4(1.00)	31.2(1.23)	22.4(0.88)	38.1(1.50)	41.3(1.63)	41.3(1.63)	33.7(1.33)	23.8(0.94)	

Метрическая трубка			Резьба NPT									
D нар. трубки T (мм)	Размер P-NPT	Артикул	Размеры, мм (дюймы)							Размер отверстия панели, мм (дюймы)	Макс. толщина панели, мм (дюймы)	
			L	B	C	E	G	F	Gx			
6	1/8	-BCF-ML6-NS2	47.2(1.86)	10.4(0.41)	15.3(0.60)	4.8(0.19)	14.0(0.55)	16.0(0.63)	16.0(0.63)	11.5(0.45)	10.2(0.40)	
6	1/4	-BCF-ML6-NS4	51.8(2.04)	15.0(0.59)	15.3(0.60)	4.8(0.19)	14.0(0.55)	19.0(0.75)	16.0(0.63)	11.5(0.45)	10.2(0.40)	
8	1/8	-BCF-ML8-NS2	49.6(1.95)	10.4(0.41)	16.2(0.64)	6.4(0.25)	16.0(0.63)	18.0(0.71)	18.0(0.71)	13.1(0.52)	11.2(0.44)	
10	1/4	-BCF-ML10-NS4	55.2(2.17)	15.0(0.59)	17.2(0.68)	7.9(0.31)	19.0(0.75)	22.0(0.87)	22.0(0.87)	16.3(0.64)	11.2(0.44)	
12	3/8	-BCF-ML12-NS6	62.9(2.48)	15.0(0.59)	22.8(0.90)	9.5(0.37)	22.0(0.87)	24.0(0.94)	24.0(0.94)	19.5(0.77)	12.7(0.50)	
12	1/2	-BCF-ML12-NS8	66.5(2.62)	19.8(0.78)	22.8(0.90)	9.5(0.37)	22.0(0.87)	27.0(1.06)	24.0(0.94)	19.5(0.77)	12.7(0.50)	

Муфта дюймовая

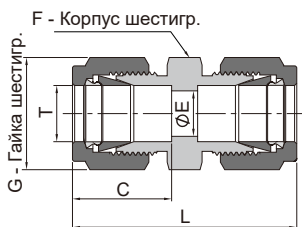

Дюймовая трубка		Размеры, мм (дюймы)				
D нар. трубки T (дюймы)	Артикул	L	C	G	F	E
		1/16	-U-FL1	25.1(0.99)	8.6(0.34)	7.9(0.31)
1/8	-U-FL2	35.6(1.40)	12.7(0.50)	11.1(0.44)	11.1(0.44)	2.3(0.09)
3/16	-U-FL3	37.3(1.47)	13.7(0.54)	12.7(0.50)	12.7(0.50)	3.0(0.12)
1/4	-U-FL4	40.9(1.61)	15.2(0.60)	14.3(0.56)	12.7(0.50)	4.8(0.19)
5/16	-U-FL5	42.9(1.69)	16.2(0.64)	15.9(0.63)	14.3(0.56)	6.4(0.25)
3/8	-U-FL6	45.0(1.77)	16.8(0.66)	17.5(0.69)	15.9(0.63)	7.1(0.28)
1/2	-U-FL8	51.3(2.02)	22.9(0.90)	22.2(0.87)	20.6(0.81)	10.4(0.41)
5/8	-U-FL10	52.1(2.05)	24.4(0.96)	25.4(1.00)	23.9(0.94)	12.7(0.50)
3/4	-U-FL12	53.6(2.11)	24.4(0.96)	28.6(1.13)	27.0(1.06)	15.7(0.62)
7/8	-U-FL14	55.7(2.19)	25.9(1.02)	31.8(1.25)	30.2(1.19)	18.3(0.72)
1	-U-FL16	64.8(2.55)	31.2(1.23)	38.1(1.5)	34.9(1.37)	22.4(0.88)
1 1/8	-U-FL18	88.2(3.47)	36.7(1.44)	44.5(1.75)	41.3(1.63)	24.6(0.97)
1 1/4	-U-FL20	92.2(3.63)	41.1(1.62)	47.6(1.87)	44.5(1.75)	27.7(1.09)
1 1/2	-U-FL24	108.0(4.25)	50.0(1.97)	57.2(2.25)	54.0(2.13)	34.0(1.34)

Муфта метрическая

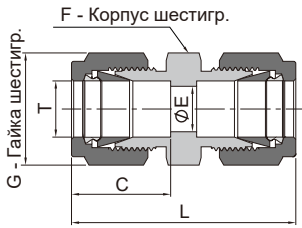

Метрическая трубка		Размеры, мм (дюймы)				
D нар. трубки T (мм)	Артикул	L	C	G	F	E
		2	-U-ML2	35.6(1.40)	12.9(0.51)	12.0(0.47)
3	-U-ML3	35.3(1.39)	12.9(0.51)	12.0(0.47)	12.0(0.47)	2.4(0.09)
4	-U-ML4	37.3(1.47)	13.7(0.54)	12.0(0.47)	12.0(0.47)	2.4(0.09)
6	-U-ML6	41.0(1.61)	15.3(0.60)	14.0(0.55)	14.0(0.55)	4.8(0.19)
8	-U-ML8	43.2(1.70)	16.2(0.64)	16.0(0.63)	15.0(0.59)	6.4(0.25)
10	-U-ML10	46.2(1.82)	17.2(0.68)	19.0(0.75)	18.0(0.71)	7.9(0.31)
12	-U-ML12	51.2(2.02)	22.8(0.90)	22.0(0.87)	22.0(0.87)	9.5(0.37)
14	-U-ML14	52.0(2.05)	24.4(0.96)	25.0(0.98)	24.0(0.94)	11.1(0.44)
15	-U-ML15	52.0(2.05)	24.4(0.96)	25.0(0.98)	24.0(0.94)	11.9(0.47)
16	-U-ML16	52.0(2.05)	24.4(0.96)	25.0(0.98)	24.0(0.94)	12.7(0.50)
18	-U-ML18	53.5(2.11)	24.4(0.96)	30.0(1.18)	27.0(1.06)	15.1(0.59)
20	-U-ML20	55.0(2.17)	26.0(1.02)	32.0(1.26)	30.0(1.18)	15.9(0.63)
22	-U-ML22	55.0(2.17)	26.0(1.02)	32.0(1.26)	30.0(1.18)	18.3(0.72)
25	-U-ML25	65.0(2.56)	31.3(1.23)	38.0(1.50)	35.0(1.38)	21.8(0.86)
28	-U-ML28	85.0(3.35)	36.6(1.44)	46.0(1.81)	41.0(1.61)	21.8(0.86)
30	-U-ML30	92.7(3.65)	39.6(1.56)	50.0(1.97)	46.0(1.81)	26.2(1.03)
32	-U-ML32	97.3(3.83)	42.0(1.65)	50.0(1.97)	46.0(1.81)	28.6(1.13)
38	-U-ML38	113.6(4.47)	49.4(1.94)	60.0(2.36)	55.0(2.17)	33.7(1.33)

Муфта переходная

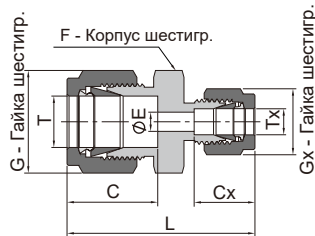

Метрическая трубка			Дюймовая трубка						
D нар. трубки T (мм)	D нар. трубки Tx (дюймы)	Артикул	Размеры, мм (дюймы)						
			L	C	G	F	E	Cx	Gx
4	1/8	-U-ML4-FL2	36.5(1.44)	13.7(0.54)	12.0(0.47)	12.0(0.47)	2.4(0.09)	12.7(0.50)	11.1(0.44)
6	1/8	-U-ML6-FL2	38.5(1.52)	15.3(0.60)	14.0(0.55)	14.0(0.55)	2.4(0.09)	12.7(0.50)	11.1(0.44)
6	5/16	-U-ML6-FL5	42.3(1.67)	15.3(0.60)	14.0(0.55)	14.0(0.55)	4.8(0.19)	15.2(0.60)	14.3(0.56)
8	1/4	-U-ML8-FL4	42.3(1.67)	16.2(0.64)	16.0(0.63)	15.0(0.59)	4.8(0.19)	15.2(0.60)	14.3(0.56)
10	1/8	-U-ML10-FL2	41.8(1.65)	17.2(0.68)	19.0(0.75)	18.0(0.71)	2.4(0.09)	12.7(0.50)	11.1(0.44)
10	1/4	-U-ML10-FL4	44.5(1.75)	17.2(0.68)	19.0(0.75)	18.0(0.71)	4.8(0.19)	15.2(0.60)	14.3(0.56)
10	5/16	-U-ML10-FL5	45.1(1.78)	17.2(0.68)	19.0(0.75)	18.0(0.71)	6.4(0.25)	16.2(0.64)	15.9(0.63)
10	3/8	-U-ML10-FL6	45.9(1.81)	17.2(0.68)	19.0(0.75)	18.0(0.71)	7.1(0.28)	16.8(0.66)	17.5(0.69)
12	5/16	-U-ML12-FL5	47.8(1.88)	22.8(0.90)	22.0(0.87)	22.0(0.87)	6.4(0.25)	16.2(0.64)	15.9(0.63)
12	3/8	-U-ML12-FL6	48.4(1.91)	22.8(0.90)	22.0(0.87)	22.0(0.87)	7.1(0.28)	16.8(0.66)	17.5(0.69)
15	1/2	-U-ML15-FL8	52.0(2.05)	24.4(0.96)	25.0(0.98)	24.0(0.94)	10.4(0.41)	22.9(0.90)	22.2(0.87)
16	5/8	-U-ML16-FL10	52.0(2.05)	24.4(0.96)	25.0(0.98)	24.0(0.94)	12.7(0.50)	24.4(0.96)	25.4(1.00)
20	1/2	-U-ML20-FL8	55.0(2.17)	26.0(1.02)	32.0(1.26)	30.0(1.18)	10.4(0.41)	22.9(0.90)	22.2(0.87)

Муфта переходная

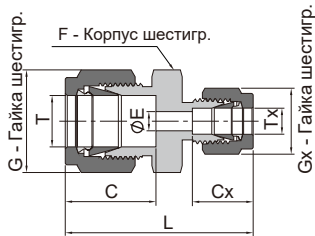

Дюймовая трубка

D нар. трубки T (дюймы)	D нар. трубки Tx (дюймы)	Артикул	Размеры, мм (дюймы)						
			L	C	G	F	E	Cx	Gx
1/8	1/16	-U-FL2-FL1	31.0(1.22)	12.7(0.50)	11.1(0.44)	11.1(0.44)	1.3(0.05)	8.6(0.34)	7.9(0.31)
3/16	1/16	-U-FL3-FL1	32.3(1.27)	13.7(0.54)	12.7(0.50)	11.1(0.44)	1.3(0.05)	8.6(0.34)	7.9(0.31)
3/16	1/8	-U-FL3-FL2	36.6(1.44)	13.7(0.54)	12.7(0.50)	11.1(0.44)	2.3(0.09)	12.7(0.50)	11.1(0.44)
1/4	1/16	-U-FL4-FL1	34.3(1.35)	15.2(0.60)	14.3(0.56)	12.7(0.50)	1.3(0.05)	8.6(0.34)	7.9(0.31)
1/4	1/8	-U-FL4-FL2	38.6(1.52)	15.2(0.60)	14.3(0.56)	12.7(0.50)	2.3(0.09)	12.7(0.50)	11.1(0.44)
1/4	3/16	-U-FL4-FL3	39.4(1.55)	15.2(0.60)	14.3(0.56)	12.7(0.50)	3.0(0.12)	13.7(0.54)	12.7(0.50)
5/16	1/8	-U-FL5-FL2	39.6(1.56)	16.2(0.64)	15.9(0.63)	14.3(0.56)	2.3(0.09)	12.7(0.50)	11.1(0.44)
5/16	1/4	-U-FL5-FL4	42.2(1.66)	16.2(0.64)	15.9(0.63)	14.3(0.56)	4.8(0.19)	15.2(0.60)	14.3(0.56)
3/8	1/16	-U-FL6-FL1	36.6(1.44)	16.8(0.66)	17.5(0.69)	15.9(0.63)	1.3(0.05)	8.6(0.34)	7.9(0.31)
3/8	1/8	-U-FL6-FL2	40.9(1.61)	16.8(0.66)	17.5(0.69)	15.9(0.63)	2.3(0.09)	12.7(0.50)	11.1(0.44)
3/8	1/4	-U-FL6-FL4	43.2(1.70)	16.8(0.66)	17.5(0.69)	15.9(0.63)	4.8(0.19)	15.2(0.60)	14.3(0.56)
3/8	5/16	-U-FL6-FL5	44.2(1.74)	16.8(0.66)	17.5(0.69)	15.9(0.63)	6.4(0.25)	16.2(0.64)	15.9(0.63)
1/2	1/8	-U-FL8-FL2	45.2(1.78)	22.8(0.90)	22.2(0.87)	20.6(0.81)	2.3(0.09)	12.7(0.50)	11.1(0.44)
1/2	1/4	-U-FL8-FL4	47.0(1.85)	22.8(0.90)	22.2(0.87)	20.6(0.81)	4.8(0.19)	15.2(0.60)	14.3(0.56)
1/2	3/8	-U-FL8-FL6	48.5(1.91)	22.8(0.90)	22.2(0.87)	20.6(0.81)	7.1(0.28)	16.8(0.66)	17.5(0.69)
5/8	3/8	-U-FL10-FL6	49.3(1.94)	24.4(0.96)	25.4(1.00)	23.9(0.94)	7.1(0.28)	16.8(0.66)	17.5(0.69)
5/8	1/2	-U-FL10-FL8	52.1(2.05)	24.4(0.96)	25.4(1.00)	23.9(0.94)	10.4(0.41)	22.8(0.90)	22.2(0.87)
3/4	1/4	-U-FL12-FL4	49.3(1.94)	24.4(0.96)	28.6(1.13)	27.0(1.06)	4.8(0.19)	15.2(0.60)	14.3(0.56)
3/4	3/8	-U-FL12-FL6	50.8(2.00)	24.4(0.96)	28.6(1.13)	27.0(1.06)	7.1(0.28)	16.8(0.66)	17.5(0.69)
3/4	1/2	-U-FL12-FL8	53.6(2.11)	24.4(0.96)	28.6(1.13)	27.0(1.06)	10.4(0.41)	22.8(0.90)	22.2(0.87)
3/4	5/8	-U-FL12-FL10	53.6(2.11)	24.4(0.96)	28.6(1.13)	27.0(1.06)	12.7(0.50)	24.4(0.96)	25.4(1.00)
1	1/2	-U-FL16-FL8	60.5(2.38)	31.2(1.23)	38.1(1.50)	34.9(1.37)	10.4(0.41)	22.8(0.90)	22.2(0.87)
1	3/4	-U-FL16-FL12	60.5(2.38)	31.2(1.23)	38.1(1.50)	34.9(1.37)	15.7(0.62)	24.4(0.96)	28.6(1.13)

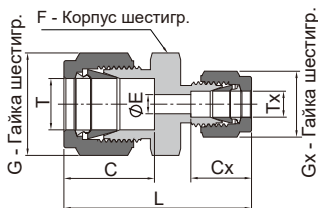

Метрическая трубка

D нар. трубки T (мм)	D нар. трубки Tx (мм)	Артикул	Размеры, мм (дюймы)						
			L	C	G	F	E	Cx	Gx
3	2	-U-ML3-ML2	35.3(1.39)	12.9(0.51)	12.0(0.47)	12.0(0.47)	1.7(0.07)	12.9(0.51)	12.0(0.47)
6	2	-U-ML6-ML2	38.6(1.52)	15.3(0.60)	14.0(0.55)	14.0(0.55)	1.7(0.07)	12.9(0.51)	12.0(0.47)
6	3	-U-ML6-ML3	38.6(1.52)	15.3(0.60)	14.0(0.55)	14.0(0.55)	2.4(0.09)	12.9(0.51)	12.0(0.47)
6	4	-U-ML6-ML4	39.4(1.55)	15.3(0.60)	14.0(0.55)	14.0(0.55)	2.4(0.09)	13.7(0.54)	12.0(0.47)
8	6	-U-ML8-ML6	42.3(1.67)	16.3(0.64)	16.0(0.63)	15.0(0.59)	4.8(0.19)	15.3(0.60)	14.0(0.55)
10	6	-U-ML10-ML6	44.5(1.75)	17.2(0.68)	19.0(0.75)	18.0(0.71)	4.8(0.19)	15.3(0.60)	14.0(0.55)
10	8	-U-ML10-ML8	45.1(1.78)	17.2(0.68)	19.0(0.75)	18.0(0.71)	6.4(0.25)	16.3(0.64)	16.0(0.63)
12	6	-U-ML12-ML6	47.0(1.85)	22.8(0.90)	22.0(0.87)	22.0(0.87)	4.8(0.19)	15.3(0.60)	14.0(0.55)
12	8	-U-ML12-ML8	47.8(1.88)	22.8(0.90)	22.0(0.87)	22.0(0.87)	6.4(0.25)	16.3(0.64)	16.0(0.63)
12	10	-U-ML12-ML10	48.7(1.92)	22.8(0.90)	22.0(0.87)	22.0(0.87)	7.9(0.31)	17.2(0.68)	19.0(0.75)
16	10	-U-ML16-ML10	49.5(1.95)	24.4(0.96)	25.0(0.98)	24.0(0.94)	7.9(0.31)	17.2(0.68)	19.0(0.75)
16	12	-U-ML16-ML12	52.0(2.05)	24.4(0.96)	25.0(0.98)	24.0(0.94)	9.5(0.37)	22.8(0.90)	22.0(0.87)
18	12	-U-ML18-ML12	53.5(2.11)	24.4(0.96)	30.0(1.18)	27.0(1.06)	9.5(0.37)	22.8(0.90)	22.0(0.87)
25	18	-U-ML25-ML18	61.0(2.40)	31.3(1.23)	38.0(1.50)	35.0(1.38)	15.1(0.59)	24.4(0.96)	30.0(1.18)
25	20	-U-ML25-ML20	62.3(2.45)	31.3(1.23)	38.0(1.50)	35.0(1.38)	15.9(0.63)	26.0(1.02)	32.0(1.26)
30	18	-U-ML30-ML18	75.4(2.97)	39.6(1.56)	50.0(1.97)	46.0(1.81)	15.1(0.59)	24.4(0.96)	30.0(1.18)
30	20	-U-ML30-ML20	75.4(2.97)	39.6(1.56)	50.0(1.97)	46.0(1.81)	15.9(0.63)	26.0(1.02)	32.0(1.26)
30	25	-U-ML30-ML25	80.1(3.15)	39.6(1.56)	50.0(1.97)	46.0(1.81)	21.8(0.86)	31.3(1.23)	38.0(1.50)
32	18	-U-ML32-ML18	77.8(3.06)	42.0(1.65)	50.0(1.97)	46.0(1.81)	15.1(0.59)	24.4(0.96)	30.0(1.18)
32	20	-U-ML32-ML20	77.8(3.06)	42.0(1.65)	50.0(1.97)	46.0(1.81)	15.9(0.63)	26.0(1.02)	32.0(1.26)
32	25	-U-ML32-ML25	82.3(3.24)	42.0(1.65)	50.0(1.97)	46.0(1.81)	21.8(0.86)	31.3(1.23)	38.0(1.50)
38	20	-U-ML38-ML20	87.5(3.44)	49.4(1.94)	60.0(2.36)	55.0(2.17)	15.9(0.63)	26.0(1.02)	32.0(1.26)
38	25	-U-ML38-ML25	92.0(3.62)	49.4(1.94)	60.0(2.36)	55.0(2.17)	21.8(0.86)	31.3(1.23)	38.0(1.50)
38	30	-U-ML38-ML30	104.6(4.12)	49.4(1.94)	60.0(2.36)	55.0(2.17)	26.2(1.03)	39.6(1.56)	50.0(1.97)

Муфта с монтажной гайкой

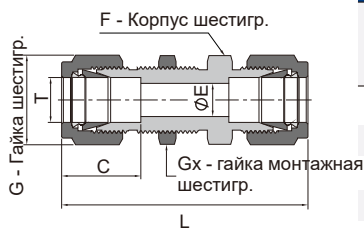

Дюймовая трубка		Размеры, мм (дюймы)						Размер отверстия панели, мм (дюйм)	Макс. толщина панели, мм (дюйм)
D нар. трубки Tx (дюймы)	Артикул	L	C	E	G	F	Gx		
1/16	-BU-FL1	31.5(1.24)	8.6(0.34)	1.3(0.05)	7.9(0.31)	7.9(0.31)	7.9(0.31)	5.2(0.20)	3.0(0.12)
1/8	-BU-FL2	51.3(2.02)	12.7(0.50)	2.3(0.09)	11.1(0.44)	12.7(0.50)	12.7(0.50)	8.3(0.33)	12.7(0.50)
3/16	-BU-FL3	53.6(2.11)	13.7(0.54)	3.0(0.12)	12.7(0.50)	14.3(0.56)	14.3(0.56)	9.9(0.39)	12.7(0.50)
1/4	-BU-FL4	57.7(2.27)	15.2(0.60)	4.8(0.19)	14.3(0.56)	15.9(0.63)	15.9(0.63)	11.5(0.45)	10.2(0.40)
5/16	-BU-FL5	60.7(2.39)	16.3(0.64)	6.4(0.25)	15.9(0.63)	17.5(0.69)	17.5(0.69)	13.1(0.52)	11.2(0.44)
3/8	-BU-FL6	62.2(2.45)	16.8(0.66)	7.1(0.28)	17.5(0.69)	19.1(0.75)	19.1(0.75)	14.7(0.58)	11.2(0.44)
1/2	-BU-FL8	71.1(2.80)	22.9(0.90)	10.4(0.41)	22.2(0.87)	23.8(0.94)	23.8(0.94)	19.4(0.76)	12.7(0.50)
5/8	-BU-FL10	72.6(2.86)	24.4(0.96)	12.7(0.50)	25.4(1.00)	27.0(1.06)	27.0(1.06)	22.6(0.89)	12.7(0.50)
3/4	-BU-FL12	79.0(3.11)	24.4(0.96)	15.7(0.62)	28.6(1.13)	30.2(1.19)	30.2(1.19)	25.8(1.02)	16.8(0.66)
7/8	-BU-FL14	85.2(3.35)	25.9(1.02)	18.3(0.72)	31.8(1.25)	34.9(1.38)	34.9(1.37)	29.0(1.14)	19.1(0.75)
1	-BU-FL16	95.8(3.77)	31.2(1.23)	22.4(0.88)	38.1(1.50)	41.3(1.63)	41.3(1.63)	33.7(1.33)	19.1(0.75)
1 1/4	-BU-FL20	123.2(4.85)	41.1(1.62)	27.8(1.09)	47.6(1.87)	47.6(1.87)	47.6(1.87)	41.7(1.64)	19.1(0.75)
1 1/2	-BU-FL24	139.2(5.48)	50.0(1.97)	34.0(1.34)	57.2(2.25)	57.2(2.25)	57.2(2.25)	49.6(1.95)	19.1(0.75)

Метрическая трубка		Размеры, мм (дюймы)						Размер отверстия панели, мм (дюймы)	Макс. толщина панели, мм (дюйм)
D нар. трубки Tx мм	Артикул	L	C	E	G	F	Gx		
3	-BU-ML3	51.3(2.02)	12.9(0.51)	2.4(0.09)	12.0(0.47)	14.0(0.55)	14.0(0.55)	8.3(0.33)	12.7(0.50)
4	-BU-ML4	53.6(2.11)	13.7(0.54)	2.4(0.09)	12.0(0.47)	14.0(0.55)	14.0(0.55)	9.9(0.39)	12.7(0.50)
6	-BU-ML6	57.7(2.27)	15.3(0.60)	4.8(0.19)	14.0(0.55)	16.0(0.63)	16.0(0.63)	11.5(0.45)	10.2(0.40)
8	-BU-ML8	61.0(2.40)	16.2(0.64)	6.4(0.25)	16.0(0.63)	18.0(0.71)	18.0(0.71)	13.1(0.52)	11.2(0.44)
10	-BU-ML10	63.7(2.51)	17.2(0.68)	7.9(0.31)	19.0(0.75)	22.0(0.87)	22.0(0.87)	16.3(0.64)	11.2(0.44)
12	-BU-ML12	71.0(2.80)	22.8(0.90)	9.5(0.37)	22.0(0.87)	24.0(0.94)	24.0(0.94)	19.5(0.77)	12.7(0.50)
14	-BU-ML14	72.5(2.85)	24.4(0.96)	11.1(0.44)	25.0(0.98)	27.0(1.06)	27.0(1.06)	22.5(0.89)	12.7(0.50)
15	-BU-ML15	72.5(2.85)	24.4(0.96)	11.9(0.47)	25.0(0.98)	27.0(1.06)	27.0(1.06)	22.8(0.90)	12.7(0.50)
16	-BU-ML16	72.5(2.85)	24.4(0.96)	12.7(0.50)	25.0(0.98)	27.0(1.06)	27.0(1.06)	22.8(0.90)	12.7(0.50)
18	-BU-ML18	78.9(3.11)	24.4(0.96)	15.1(0.59)	30.0(1.18)	30.0(1.18)	30.0(1.18)	26.0(1.02)	16.8(0.66)
20	-BU-ML20	84.5(3.33)	26.0(1.02)	15.9(0.63)	32.0(1.26)	35.0(1.38)	35.0(1.38)	29.0(1.14)	19.0(0.75)
25	-BU-ML25	96.0(3.78)	31.3(1.23)	21.8(0.86)	38.0(1.5)	41.0(1.61)	41.0(1.61)	34.0(1.34)	19.0(0.75)
30	-BU-ML30	124.0(4.88)	39.6(1.56)	26.2(1.03)	50.0(1.97)	50.0(1.97)	50.0(1.97)	40.5(1.59)	19.0(0.75)
32	-BU-ML32	128.0(5.04)	42.0(1.65)	28.6(1.13)	50.0(1.97)	50.0(1.97)	50.0(1.97)	42.5(1.67)	19.0(0.75)
38	-BU-ML38	145.0(5.71)	49.4(1.94)	33.7(1.33)	60.0(2.36)	60.0(2.36)	60.0(2.36)	50.5(1.99)	19.0(0.75)

Муфта переходная с монтажной гайкой

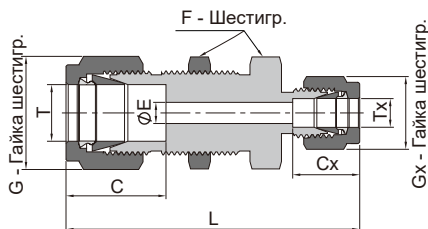

Дюймовая трубка			Размеры, мм (дюймы)						Размер отверстия панели, мм (дюйм)	Макс. толщина панели, мм (дюйм)	
D нар. трубки T (дюймы)	D нар. трубки Tx (дюймы)	Артикул	L	C	E	G	F	Cx			Gx
1/4	1/8	-BU-FL4-FL2	55.1(2.17)	15.2(0.60)	2.3(0.09)	14.3(0.56)	15.9(0.63)	12.7(0.50)	11.1(0.44)	11.5(0.45)	10.2(0.40)
3/8	1/4	-BU-FL6-FL4	60.7(2.39)	16.8(0.66)	4.8(0.19)	17.5(0.69)	19.1(0.75)	15.2(0.60)	14.3(0.56)	14.7(0.58)	11.2(0.44)
1/2	1/4	-BU-FL8-FL4	66.8(2.63)	22.9(0.90)	4.8(0.19)	22.2(0.87)	23.8(0.94)	15.2(0.60)	14.3(0.56)	19.4(0.76)	12.7(0.50)

Муфта переходная с монтажной гайкой

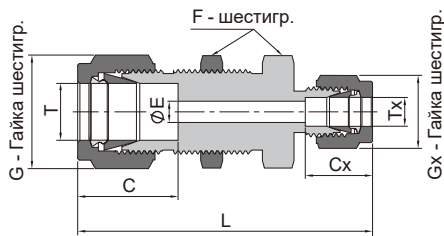

Метрическая трубка

D нар. трубки T мм	D нар. трубки Tx мм	Артикул	Размеры, мм (дюймы)							Размер отверстия панели, мм (дюймы)	Макс. толщина панели, мм (дюймы)
			L	C	E	G	F	Cx	Gx		
6	3	-BU-ML6-ML3	55.1(2.17)	15.3(0.60)	2.4(0.09)	14.0(0.55)	16.0(0.63)	12.9(0.51)	12.0(0.47)	11.5(0.45)	10.2(0.40)
8	6	-BU-ML8-ML6	60.1(2.37)	16.2(0.64)	4.8(0.19)	16.0(0.63)	18.0(0.71)	15.3(0.60)	14.0(0.55)	13.1(0.52)	11.2(0.44)
12	8	-BU-ML12-ML8	67.6(2.66)	22.8(0.90)	6.4(0.25)	22.0(0.87)	24.0(0.94)	16.2(0.64)	16.0(0.63)	19.5(0.77)	12.7(0.50)

Муфта переходная с монтажной гайкой

Дюймовая трубка

Метрическая трубка

D нар. трубки T дюймы	D нар. трубки Tx мм	Артикул	Размеры, мм (дюймы)							Размер отверстия панели, мм (дюйм)	Макс. толщина панели, мм (дюйм)
			L	C	E	G	F	Cx	Gx		
1/4	6	-BU-FL4-ML6	57.7(2.27)	15.2(0.60)	4.8(0.19)	14.3(0.56)	15.9(0.63)	15.3(0.60)	14.0(0.55)	11.5(0.45)	10.2(0.40)

Метрическая трубка

Дюймовая трубка

D нар. трубки T мм	D нар. трубки Tx дюймы	Артикул	Размеры, мм (дюймы)							Размер отверстия панели, мм (дюймы)	Макс. толщина панели, мм (дюймы)
			L	C	E	G	F	Cx	Gx		
6	1/8	-BU-ML6-FL2	55.1(2.17)	15.3(0.60)	2.3(0.09)	14.0(0.55)	16.0(0.63)	12.7(0.5)	11.0(0.43)	11.5(0.45)	10.2(0.40)
6	1/4	-BU-ML6-FL4	57.7(2.27)	15.3(0.60)	4.8(0.19)	14.0(0.55)	16.0(0.63)	15.2(0.6)	14.3(0.56)	11.5(0.45)	10.2(0.40)

Гайка для крепления на панель



Дюймовая трубка

D нар. трубки T дюймы	Артикул
1/16	-BN-FL1
1/8	-BN-FL2
3/16	-BN-FL3
1/4	-BN-FL4
5/16	-BN-FL5
3/8	-BN-FL6
1/2	-BN-FL8
5/8	-BN-FL10
3/4	-BN-FL12
7/8	-BN-FL14
1	-BN-FL16
1 1/4	-BN-FL20
1 1/2	-BN-FL24

Метрическая трубка

D нар. трубки T мм	Артикул
3	-BN-ML3
4	-BN-ML4
6	-BN-ML6
8	-BN-ML8
10	-BN-ML10
12	-BN-ML12
14	-BN-ML14
18	-BN-ML18
20	-BN-ML20
22	-BN-ML22
25	-BN-ML25
28	-BN-ML28
30	-BN-ML30
32	-BN-ML32
38	-BN-ML38

Угольник ввертной 90°

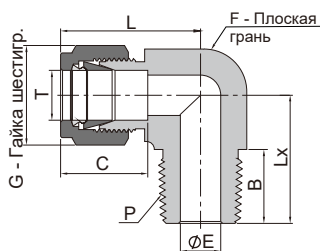

Обжимные
фитинги

Дюймовая трубка			Резьба NPT							
D нар. трубки T (дюймы)	Размер P-NPT	Артикул	Размеры, мм (дюймы)							
			L	C	G	F	E	B	Lx	
1/16	1/16	-LM-FL1-NS1	19.1(0.75)	8.6(0.34)	7.9(0.31)	11.1(0.44)	1.3(0.05)	9.7(0.38)	17.8(0.70)	
1/16	1/8	-LM-FL1-NS2	19.1(0.75)	8.6(0.34)	7.9(0.31)	11.1(0.44)	1.3(0.05)	9.7(0.38)	17.8(0.70)	
1/8	1/16	-LM-FL2-NS1	23.6(0.93)	12.7(0.50)	11.1(0.44)	11.1(0.44)	2.4(0.09)	9.7(0.38)	17.8(0.70)	
1/8	1/8	-LM-FL2-NS2	23.6(0.93)	12.7(0.50)	11.1(0.44)	11.1(0.44)	2.4(0.09)	9.7(0.38)	17.8(0.70)	
1/8	1/4	-LM-FL2-NS4	24.6(0.97)	12.7(0.50)	11.1(0.44)	12.7(0.50)	2.4(0.09)	14.2(0.56)	23.4(0.92)	
3/16	1/8	-LM-FL3-NS2	25.4(1.00)	13.7(0.54)	12.7(0.50)	12.7(0.50)	3.0(0.12)	9.7(0.38)	18.8(0.74)	
3/16	1/4	-LM-FL3-NS4	25.4(1.00)	13.7(0.54)	12.7(0.50)	12.7(0.50)	3.0(0.12)	14.2(0.56)	23.4(0.92)	
1/4	1/16	-LM-FL4-NS1	26.9(1.06)	15.2(0.60)	14.3(0.56)	12.7(0.50)	3.0(0.12)	9.7(0.38)	18.8(0.74)	
1/4	1/8	-LM-FL4-NS2	26.9(1.06)	15.2(0.60)	14.3(0.56)	12.7(0.50)	4.8(0.19)	9.7(0.38)	18.8(0.74)	
1/4	1/4	-LM-FL4-NS4	26.9(1.06)	15.2(0.60)	14.3(0.56)	12.7(0.50)	4.8(0.19)	14.2(0.56)	23.4(0.92)	
1/4	3/8	-LM-FL4-NS6	29.7(1.17)	15.2(0.60)	14.3(0.56)	17.5(0.69)	4.8(0.19)	14.2(0.56)	26.2(1.03)	
1/4	1/2	-LM-FL4-NS8	31.8(1.25)	15.2(0.60)	14.3(0.56)	20.6(0.81)	4.8(0.19)	19.1(0.75)	33.0(1.30)	
5/16	1/8	-LM-FL5-NS2	28.7(1.13)	16.3(0.64)	15.9(0.63)	14.3(0.56)	4.8(0.19)	9.7(0.38)	19.8(0.78)	
5/16	1/4	-LM-FL5-NS4	28.7(1.13)	16.3(0.64)	15.9(0.63)	14.3(0.56)	6.4(0.25)	14.2(0.56)	24.4(0.96)	
5/16	3/8	-LM-FL5-NS6	30.5(1.20)	16.3(0.64)	15.9(0.63)	17.5(0.69)	6.4(0.25)	14.2(0.56)	26.2(1.03)	
3/8	1/8	-LM-FL6-NS2	30.5(1.20)	16.8(0.66)	17.5(0.69)	15.9(0.63)	4.8(0.19)	9.7(0.38)	20.8(0.82)	
3/8	1/4	-LM-FL6-NS4	30.5(1.20)	16.8(0.66)	17.5(0.69)	15.9(0.63)	7.1(0.28)	14.2(0.56)	25.4(1.00)	
3/8	3/8	-LM-FL6-NS6	31.2(1.23)	16.8(0.66)	17.5(0.69)	17.5(0.69)	7.1(0.28)	14.2(0.56)	26.2(1.03)	
3/8	1/2	-LM-FL6-NS8	33.3(1.31)	16.8(0.66)	17.5(0.69)	20.6(0.81)	7.1(0.28)	19.1(0.75)	33.0(1.30)	
3/8	3/4	-LM-FL6-NS12	37.1(1.46)	16.8(0.66)	17.5(0.69)	27.0(1.06)	7.1(0.28)	19.1(0.75)	36.8(1.45)	
1/2	1/4	-LM-FL8-NS4	36.1(1.42)	22.9(0.90)	22.2(0.87)	20.6(0.81)	7.1(0.28)	14.2(0.56)	28.2(1.11)	
1/2	3/8	-LM-FL8-NS6	36.1(1.42)	22.9(0.90)	22.2(0.87)	20.6(0.81)	9.7(0.38)	14.2(0.56)	28.2(1.11)	
1/2	1/2	-LM-FL8-NS8	36.1(1.42)	22.9(0.90)	22.2(0.87)	20.6(0.81)	10.4(0.41)	19.1(0.75)	33.0(1.30)	
1/2	3/4	-LM-FL8-NS12	39.9(1.57)	22.9(0.90)	22.2(0.87)	27.0(1.06)	10.4(0.41)	19.1(0.75)	36.8(1.45)	
5/8	3/8	-LM-FL10-NS6	38.1(1.50)	24.4(0.96)	25.4(1.00)	23.8(0.94)	9.7(0.38)	14.2(0.56)	30.2(1.19)	
5/8	1/2	-LM-FL10-NS8	38.1(1.50)	24.4(0.96)	25.4(1.00)	23.8(0.94)	11.9(0.47)	19.1(0.75)	35.1(1.38)	
5/8	3/4	-LM-FL10-NS12	39.9(1.57)	24.4(0.96)	25.4(1.00)	27.0(1.06)	12.7(0.50)	19.1(0.75)	36.8(1.45)	
3/4	1/2	-LM-FL12-NS8	39.9(1.57)	24.4(0.96)	28.6(1.13)	27.0(1.06)	11.9(0.47)	19.1(0.75)	36.8(1.45)	
3/4	3/4	-LM-FL12-NS12	39.9(1.57)	24.4(0.96)	28.6(1.13)	27.0(1.06)	15.7(0.62)	19.1(0.75)	36.8(1.45)	
7/8	3/4	-LM-FL14-NS12	44.7(1.76)	25.9(1.02)	31.8(1.25)	34.9(1.37)	15.7(0.62)	19.1(0.75)	41.7(1.64)	
1	3/4	-LM-FL16-NS12	49.0(1.93)	31.2(1.23)	38.1(1.50)	34.9(1.37)	15.7(0.62)	19.1(0.75)	41.7(1.64)	
1	1	-LM-FL16-NS16	49.0(1.93)	31.2(1.23)	38.1(1.50)	34.9(1.37)	22.4(0.88)	23.9(0.94)	46.5(1.83)	
1 1/4	1 1/4	-LM-FL20-NS20	66.5(2.62)	41.1(1.62)	47.6(1.87)	42.9(1.69)	27.7(1.09)	23.9(0.94)	52.4(2.06)	
1 1/2	1 1/2	-LM-FL24-NS24	78.0(3.07)	50.0(1.97)	57.2(2.25)	50.8(2.00)	34.0(1.34)	26.2(1.03)	60.5(2.38)	

Дюймовая трубка			Коническая резьба ISO (RT)							
D нар. трубки T (дюймы)	Размер P-RT	Артикул	Размеры, мм (дюймы)							
			L	C	G	F	E	B	Lx	
1/8	1/8	-LM-FL2-RT2	23.6(0.93)	12.7(0.50)	11.1(0.44)	11.1(0.44)	2.4(0.09)	9.7(0.38)	22.2(0.87)	
1/8	1/4	-LM-FL2-RT4	24.6(0.97)	12.7(0.50)	11.1(0.44)	12.7(0.50)	2.4(0.09)	14.2(0.56)	23.4(0.92)	
1/4	1/8	-LM-FL4-RT2	26.9(1.06)	15.2(0.60)	14.3(0.56)	12.7(0.50)	4.8(0.19)	9.7(0.38)	18.8(0.74)	
1/4	1/4	-LM-FL4-RT4	26.9(1.06)	15.2(0.60)	14.3(0.56)	12.7(0.50)	4.8(0.19)	14.2(0.56)	23.4(0.92)	
1/4	3/8	-LM-FL4-RT6	29.7(1.17)	15.2(0.60)	14.3(0.56)	17.5(0.69)	4.8(0.19)	14.2(0.56)	26.2(1.03)	
1/4	1/2	-LM-FL4-RT8	31.8(1.25)	15.2(0.60)	14.3(0.56)	20.6(0.81)	4.8(0.19)	19.1(0.75)	33.0(1.30)	
5/16	1/4	-LM-FL5-RT4	28.7(1.13)	16.3(0.64)	15.9(0.63)	14.3(0.56)	6.4(0.25)	14.2(0.56)	24.4(0.96)	
3/8	1/8	-LM-FL6-RT2	30.5(1.20)	16.8(0.66)	17.5(0.69)	15.9(0.63)	4.8(0.19)	9.7(0.38)	20.8(0.82)	
3/8	1/4	-LM-FL6-RT4	30.5(1.20)	16.8(0.66)	17.5(0.69)	15.9(0.63)	7.1(0.28)	14.2(0.56)	25.4(1.00)	
3/8	3/8	-LM-FL6-RT6	31.2(1.23)	16.8(0.66)	17.5(0.69)	17.5(0.69)	7.1(0.28)	14.2(0.56)	26.2(1.03)	
1/2	3/8	-LM-FL8-RT6	36.1(1.42)	22.9(0.90)	22.2(0.87)	20.6(0.81)	9.7(0.38)	14.2(0.56)	28.2(1.11)	
1/2	1/2	-LM-FL8-RT8	36.1(1.42)	22.9(0.90)	22.2(0.87)	20.6(0.81)	10.4(0.41)	19.1(0.75)	33.0(1.30)	
3/4	1/2	-LM-FL12-RT8	39.9(1.57)	24.4(0.96)	28.6(1.13)	27.0(1.06)	9.5(0.37)	19.1(0.75)	36.8(1.45)	
1	1	-LM-FL16-RT16	49.0(1.93)	31.2(1.23)	38.1(1.50)	34.9(1.37)	22.4(0.88)	23.9(0.94)	46.5(1.83)	

Угольник ввертной 90°

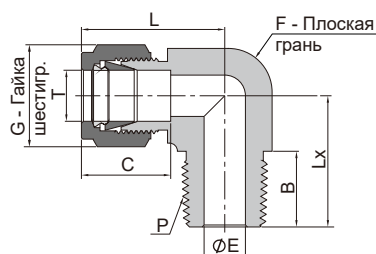

Метрическая трубка			Резьба NPT							
D нар. трубки T (мм)	Размер P-NPT	Артикул	Размеры, мм (дюймы)							
			L	C	G	F	E	B	Lx	
3	1/8	-LM-ML3-NS2	23.6(0.93)	12.9(0.51)	12.0(0.47)	11.1(0.44)	2.4(0.09)	9.7(0.38)	17.8(0.70)	
3	1/4	-LM-ML3-NS4	24.6(0.97)	12.9(0.51)	12.0(0.47)	12.7(0.50)	2.4(0.09)	14.2(0.56)	23.4(0.92)	
4	1/8	-LM-ML4-NS2	25.4(1.00)	13.7(0.54)	12.0(0.47)	12.7(0.50)	2.4(0.09)	9.7(0.38)	18.8(0.74)	
4	1/4	-LM-ML4-NS4	25.4(1.00)	13.7(0.54)	12.0(0.47)	12.7(0.50)	2.4(0.09)	14.2(0.56)	23.4(0.92)	
6	1/8	-LM-ML6-NS2	27.0(1.06)	15.3(0.60)	14.0(0.55)	12.7(0.50)	4.8(0.19)	9.7(0.38)	18.8(0.74)	
6	1/4	-LM-ML6-NS4	27.0(1.06)	15.3(0.60)	14.0(0.55)	12.7(0.50)	4.8(0.19)	14.2(0.56)	23.4(0.92)	
6	3/8	-LM-ML6-NS6	29.8(1.17)	15.3(0.60)	14.0(0.55)	17.5(0.69)	4.8(0.19)	14.2(0.56)	26.2(1.03)	
6	1/2	-LM-ML6-NS8	31.8(1.25)	15.3(0.60)	14.0(0.55)	20.6(0.81)	4.8(0.19)	19.1(0.75)	33.0(1.30)	
8	1/8	-LM-ML8-NS2	28.8(1.13)	16.2(0.64)	16.0(0.63)	14.3(0.56)	4.8(0.19)	9.7(0.38)	19.8(0.78)	
8	1/4	-LM-ML8-NS4	28.8(1.13)	16.2(0.64)	16.0(0.63)	14.3(0.56)	6.4(0.25)	14.2(0.56)	24.4(0.96)	
8	3/8	-LM-ML8-NS6	30.6(1.20)	16.2(0.64)	16.0(0.63)	17.5(0.69)	6.4(0.25)	14.2(0.56)	26.2(1.03)	
8	1/2	-LM-ML8-NS8	32.6(1.28)	16.2(0.64)	16.0(0.63)	20.6(0.81)	6.4(0.25)	19.1(0.75)	33.0(1.30)	
10	1/8	-LM-ML10-NS2	31.5(1.24)	17.2(0.68)	19.0(0.75)	17.5(0.69)	4.8(0.19)	9.7(0.38)	21.6(0.85)	
10	1/4	-LM-ML10-NS4	31.5(1.24)	17.2(0.68)	19.0(0.75)	17.5(0.69)	7.1(0.28)	14.2(0.56)	26.2(1.03)	
10	3/8	-LM-ML10-NS6	31.5(1.24)	17.2(0.68)	19.0(0.75)	17.5(0.69)	7.9(0.31)	14.2(0.56)	26.2(1.03)	
10	1/2	-LM-ML10-NS8	33.5(1.32)	17.2(0.68)	19.0(0.75)	20.6(0.81)	7.9(0.31)	19.1(0.75)	33.0(1.30)	
12	1/8	-LM-ML12-NS2	36.0(1.42)	22.8(0.90)	22.0(0.87)	20.6(0.81)	4.8(0.19)	9.7(0.38)	23.6(0.93)	
12	1/4	-LM-ML12-NS4	36.0(1.42)	22.8(0.90)	22.0(0.87)	20.6(0.81)	7.1(0.28)	14.2(0.56)	28.2(1.11)	
12	3/8	-LM-ML12-NS6	36.0(1.42)	22.8(0.90)	22.0(0.87)	20.6(0.81)	9.5(0.37)	14.2(0.56)	28.2(1.11)	
12	1/2	-LM-ML12-NS8	36.0(1.42)	22.8(0.90)	22.0(0.87)	20.6(0.81)	9.5(0.37)	19.1(0.75)	33.0(1.30)	
12	3/4	-LM-ML12-NS12	39.8(1.57)	22.8(0.90)	22.0(0.87)	27.0(1.06)	9.5(0.37)	19.1(0.75)	36.8(1.45)	
15	1/2	-LM-ML15-NS8	38.0(1.50)	24.4(0.96)	25.0(0.98)	23.8(0.94)	11.9(0.47)	19.1(0.75)	35.1(1.38)	
16	1/4	-LM-ML16-NS4	38.0(1.50)	24.4(0.96)	25.0(0.98)	23.8(0.94)	7.1(0.28)	14.2(0.56)	30.2(1.19)	
16	3/8	-LM-ML16-NS6	38.0(1.50)	24.4(0.96)	25.0(0.98)	23.8(0.94)	9.5(0.37)	14.2(0.56)	30.2(1.19)	
16	1/2	-LM-ML16-NS8	38.0(1.50)	24.4(0.96)	25.0(0.98)	23.8(0.94)	11.9(0.47)	19.1(0.75)	35.1(1.38)	
16	3/4	-LM-ML16-NS12	39.8(1.57)	24.4(0.96)	25.0(0.98)	27.0(1.06)	12.7(0.50)	19.1(0.75)	36.8(1.45)	
18	1/2	-LM-ML18-NS8	39.8(1.57)	24.4(0.96)	30.0(1.18)	27.0(1.06)	11.9(0.47)	19.1(0.75)	36.8(1.45)	
18	3/4	-LM-ML18-NS12	39.8(1.57)	24.4(0.96)	30.0(1.18)	27.0(1.06)	15.1(0.59)	19.1(0.75)	36.8(1.45)	
20	1/2	-LM-ML20-NS8	44.6(1.76)	26.0(1.02)	32.0(1.26)	34.9(1.37)	11.9(0.47)	19.1(0.75)	41.7(1.64)	
20	3/4	-LM-ML20-NS12	44.6(1.76)	26.0(1.02)	32.0(1.26)	34.9(1.37)	15.9(0.63)	19.1(0.75)	41.7(1.64)	
22	3/4	-LM-ML22-NS12	44.6(1.76)	26.0(1.02)	32.0(1.26)	34.9(1.37)	15.9(0.63)	19.1(0.75)	41.7(1.64)	
22	1	-LM-ML22-NS16	44.6(1.76)	26.0(1.02)	32.0(1.26)	34.9(1.37)	18.3(0.72)	23.9(0.94)	46.5(1.83)	
25	3/4	-LM-ML25-NS12	49.1(1.93)	31.3(1.23)	38.0(1.50)	34.9(1.37)	15.9(0.63)	19.1(0.75)	41.7(1.64)	
25	1	-LM-ML25-NS16	49.1(1.93)	31.3(1.23)	38.0(1.50)	34.9(1.37)	21.8(0.86)	23.9(0.94)	46.5(1.83)	
30	1 1/4	-LM-ML30-NS20	69.9(2.75)	39.6(1.56)	50.0(1.97)	42.9(1.69)	26.2(1.03)	23.9(0.94)	53.1(2.09)	
32	1 1/4	-LM-ML32-NS20	72.3(2.85)	42.0(1.65)	50.0(1.97)	42.9(1.69)	27.8(1.09)	23.9(0.94)	53.1(2.09)	
38	1 1/2	-LM-ML38-NS24	84.0(3.31)	49.4(1.94)	60.0(2.36)	50.8(2.00)	33.7(1.33)	26.2(1.03)	60.4(2.38)	

Угольник ввертной 90°

Обжимные
фитинги

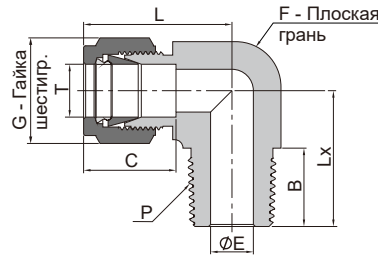

Метрическая трубка			Коническая резьба ISO (RT)						
D нар. трубки T (мм)	Размер P-RT	Артикул	Размеры, мм (дюймы)						
			L	C	G	F	E	B	Lx
3	1/8	-LM-ML3-RT2	23.6(0.93)	12.9(0.51)	12.0(0.47)	11.1(0.44)	2.4(0.09)	9.7(0.38)	17.8(0.70)
3	1/4	-LM-ML3-RT4	24.6(0.97)	12.9(0.51)	12.0(0.47)	12.7(0.50)	2.4(0.09)	14.2(0.56)	23.4(0.92)
4	1/8	-LM-ML4-RT2	25.4(1.00)	13.7(0.54)	12.0(0.47)	12.7(0.50)	2.4(0.09)	9.7(0.38)	18.8(0.74)
4	1/4	-LM-ML4-RT4	25.4(1.00)	13.7(0.54)	12.0(0.47)	12.7(0.50)	2.4(0.09)	14.2(0.56)	23.4(0.92)
6	1/8	-LM-ML6-RT2	27.0(1.06)	15.3(0.60)	14.0(0.55)	12.7(0.50)	4.8(0.19)	9.7(0.38)	18.8(0.74)
6	1/4	-LM-ML6-RT4	27.0(1.06)	15.3(0.60)	14.0(0.55)	12.7(0.50)	4.8(0.19)	14.2(0.56)	23.4(0.92)
6	3/8	-LM-ML6-RT6	29.8(1.17)	15.3(0.60)	14.0(0.55)	17.5(0.69)	4.8(0.19)	14.2(0.56)	26.2(1.03)
6	1/2	-LM-ML6-RT8	31.8(1.25)	15.3(0.60)	14.0(0.55)	20.6(0.81)	4.8(0.19)	19.1(0.75)	33.0(1.30)
8	1/8	-LM-ML8-RT2	28.8(1.13)	16.2(0.64)	16.0(0.63)	14.3(0.56)	4.8(0.19)	9.7(0.38)	19.8(0.78)
8	1/4	-LM-ML8-RT4	28.8(1.13)	16.2(0.64)	16.0(0.63)	14.3(0.56)	6.4(0.25)	14.2(0.56)	24.4(0.96)
8	3/8	-LM-ML8-RT6	30.6(1.20)	16.2(0.64)	16.0(0.63)	17.5(0.69)	6.4(0.25)	14.2(0.56)	26.2(1.03)
8	1/2	-LM-ML8-RT8	32.6(1.28)	16.2(0.64)	16.0(0.63)	20.6(0.81)	6.4(0.25)	19.1(0.75)	33.0(1.30)
10	1/8	-LM-ML10-RT2	31.5(1.24)	17.2(0.68)	19.0(0.75)	17.5(0.69)	4.8(0.19)	9.7(0.38)	21.6(0.85)
10	1/4	-LM-ML10-RT4	31.5(1.24)	17.2(0.68)	19.0(0.75)	17.5(0.69)	7.1(0.28)	14.2(0.56)	26.2(1.03)
10	3/8	-LM-ML10-RT6	31.5(1.24)	17.2(0.68)	19.0(0.75)	17.5(0.69)	7.9(0.31)	14.2(0.56)	26.2(1.03)
10	1/2	-LM-ML10-RT8	33.5(1.32)	17.2(0.68)	19.0(0.75)	20.6(0.81)	7.9(0.31)	19.1(0.75)	33.0(1.30)
12	1/8	-LM-ML12-RT2	36.0(1.42)	22.8(0.90)	22.0(0.87)	20.6(0.81)	4.8(0.19)	9.7(0.38)	23.6(0.93)
12	1/4	-LM-ML12-RT4	36.0(1.42)	22.8(0.90)	22.0(0.87)	20.6(0.81)	7.1(0.28)	14.2(0.56)	28.2(1.11)
12	3/8	-LM-ML12-RT6	36.0(1.42)	22.8(0.90)	22.0(0.87)	20.6(0.81)	9.5(0.37)	14.2(0.56)	28.2(1.11)
12	1/2	-LM-ML12-RT8	36.0(1.42)	22.8(0.90)	22.0(0.87)	20.6(0.81)	9.5(0.37)	19.1(0.75)	33.0(1.30)
12	3/4	-LM-ML12-RT12	39.8(1.57)	22.8(0.90)	22.0(0.87)	27.0(1.06)	9.5(0.37)	19.1(0.75)	36.8(1.45)
14	1/2	-LM-ML14-RT8	38.1(1.50)	24.4(0.96)	25.0(0.98)	23.8(0.94)	11.1(0.44)	19.1(0.75)	35.1(1.38)
15	1/2	-LM-ML15-RT8	38.1(1.50)	24.4(0.96)	25.0(0.98)	23.8(0.94)	11.9(0.47)	19.1(0.75)	35.1(1.38)
16	1/4	-LM-ML16-RT4	38.0(1.50)	24.4(0.96)	25.0(0.98)	23.8(0.94)	7.1(0.28)	14.2(0.56)	30.2(1.19)
16	3/8	-LM-ML16-RT6	38.0(1.50)	24.4(0.96)	25.0(0.98)	23.8(0.94)	9.5(0.37)	14.2(0.56)	30.2(1.19)
16	1/2	-LM-ML16-RT8	38.0(1.50)	24.4(0.96)	25.0(0.98)	23.8(0.94)	11.9(0.47)	19.1(0.75)	35.1(1.38)
16	3/4	-LM-ML16-RT12	39.8(1.57)	24.4(0.96)	25.0(0.98)	27.0(1.06)	12.7(0.50)	19.1(0.75)	36.8(1.45)
18	1/2	-LM-ML18-RT8	39.8(1.57)	24.4(0.96)	30.0(1.18)	27.0(1.06)	11.9(0.47)	19.1(0.75)	36.8(1.45)
18	3/4	-LM-ML18-RT12	39.8(1.57)	24.4(0.96)	30.0(1.18)	27.0(1.06)	15.1(0.59)	19.1(0.75)	36.8(1.45)
20	1/2	-LM-ML20-RT8	44.6(1.76)	26.0(1.02)	32.0(1.26)	34.9(1.37)	11.9(0.47)	19.1(0.75)	41.7(1.64)
20	3/4	-LM-ML20-RT12	44.6(1.76)	26.0(1.02)	32.0(1.26)	34.9(1.37)	15.9(0.63)	19.1(0.75)	41.7(1.64)
22	3/4	-LM-ML22-RT12	44.6(1.76)	26.0(1.02)	32.0(1.26)	34.9(1.37)	15.9(0.63)	19.1(0.75)	41.7(1.64)
22	1	-LM-ML22-RT16	44.6(1.76)	26.0(1.02)	32.0(1.26)	34.9(1.37)	18.3(0.72)	23.9(0.94)	46.5(1.83)
25	3/4	-LM-ML25-RT12	49.1(1.93)	31.3(0.90)	38.0(1.50)	34.9(1.37)	15.9(0.63)	19.1(0.75)	41.7(1.64)
25	1	-LM-ML25-RT16	49.1(1.93)	31.3(0.90)	38.0(1.50)	34.9(1.37)	21.8(0.86)	23.9(0.94)	46.5(1.83)
28	1	-LM-ML28-RT16	64.0(2.52)	36.6(0.90)	46.0(1.81)	42.9(1.69)	21.8(0.86)	23.9(0.94)	53.1(2.09)

Угольник ввертной с углом 45°

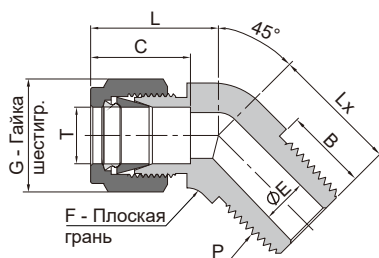

Дюймовая трубка			Резьба NPT							
D нар. трубки T (дюймы)	Размер P-NPT	Артикул	Размеры, мм (дюймы)							
			L	C	G	F	E	B	Lx	
1/16	1/16	-VM-FL1-NS1	20.8(0.82)	8.6(0.34)	7.9(0.31)	11.1(0.44)	1.3(0.05)	9.7(0.38)	16.8(0.66)	
1/8	1/8	-VM-FL2-NS2	20.8(0.82)	12.7(0.50)	11.1(0.44)	11.1(0.44)	2.3(0.09)	9.7(0.38)	16.8(0.66)	
3/16	1/8	-VM-FL3-NS2	21.6(0.85)	13.7(0.54)	12.7(0.50)	11.1(0.44)	3.0(0.12)	9.7(0.38)	14.7(0.58)	
1/4	1/8	-VM-FL4-NS2	24.6(0.97)	15.2(0.60)	14.3(0.56)	12.7(0.50)	4.8(0.19)	9.7(0.38)	16.5(0.65)	
1/4	1/4	-VM-FL4-NS4	24.6(0.97)	15.2(0.60)	14.3(0.56)	12.7(0.50)	4.8(0.19)	14.2(0.56)	21.1(0.83)	
5/16	1/8	-VM-FL5-NS2	24.0(0.94)	16.3(0.64)	15.9(0.63)	14.3(0.56)	4.8(0.19)	9.7(0.38)	16.8(0.66)	
3/8	1/8	-VM-FL6-NS2	27.9(1.10)	16.8(0.66)	17.5(0.69)	15.9(0.63)	4.8(0.19)	9.7(0.38)	18.3(0.72)	
3/8	1/4	-VM-FL6-NS4	27.9(1.10)	16.8(0.66)	17.5(0.69)	15.9(0.63)	7.1(0.28)	14.2(0.56)	22.9(0.90)	
3/8	3/8	-VM-FL6-NS6	29.2(1.15)	16.8(0.66)	17.5(0.69)	20.6(0.81)	7.1(0.28)	14.2(0.56)	24.1(0.95)	
1/2	3/8	-VM-FL8-NS6	32.0(1.26)	22.9(0.90)	22.2(0.87)	20.6(0.81)	9.7(0.38)	14.2(0.56)	24.1(0.95)	
5/8	1/2	-VM-FL10-NS8	30.7(1.21)	24.4(0.96)	25.4(1.00)	23.8(0.94)	11.9(0.47)	14.2(0.56)	29.7(1.17)	
3/4	3/4	-VM-FL12-NS12	34.0(1.34)	24.4(0.96)	28.6(1.13)	27.0(1.06)	11.9(0.47)	19.1(0.75)	31.0(1.22)	
7/8	3/4	-VM-FL14-NS12	40.4(1.59)	25.9(1.02)	31.8(1.25)	31.8(1.25)	15.7(0.62)	19.1(0.75)	32.3(1.27)	
1	1	-VM-FL16-NS16	40.4(1.59)	31.2(1.23)	38.1(1.50)	34.9(1.37)	22.4(0.88)	23.9(0.94)	37.8(1.49)	

Метрическая трубка			Резьба NPT							
D нар. трубки T (мм)	Размер P-NPT	Артикул	Размеры, мм (дюймы)							
			L	C	G	F	E	B	Lx	
6	1/8	-VM-ML6-NS2	23.4(0.92)	15.3(0.60)	14.0(0.55)	12.7(0.50)	4.8(0.19)	9.7(0.38)	16.8(0.66)	
6	1/4	-VM-ML6-NS4	23.4(0.92)	15.3(0.60)	14.0(0.55)	12.7(0.50)	4.8(0.19)	14.2(0.56)	21.8(0.86)	
8	1/8	-VM-ML8-NS2	24.3(0.96)	16.2(0.64)	16.0(0.63)	15.9(0.63)	4.8(0.19)	9.7(0.38)	16.8(0.66)	
10	1/4	-VM-ML10-NS4	26.6(1.05)	17.2(0.68)	19.0(0.75)	17.5(0.69)	7.9(0.31)	14.2(0.56)	24.1(0.95)	
12	3/8	-VM-ML12-NS6	29.1(1.15)	22.8(0.90)	22.0(0.87)	20.6(0.81)	9.5(0.37)	14.2(0.56)	24.1(0.95)	
12	1/2	-VM-ML12-NS8	30.7(1.21)	22.8(0.90)	22.0(0.87)	20.6(0.81)	9.5(0.37)	19.1(0.75)	29.7(1.17)	
16	1/2	-VM-ML16-NS8	30.7(1.21)	24.4(0.96)	25.0(0.98)	23.8(0.94)	11.9(0.47)	19.1(0.75)	29.7(1.17)	

Угольник ввертной 90° с гайкой для позиционирования

Прямая резьба SAE/MS

Совместим с внутренней резьбой SAE J1926-1, ISO 11926-1 и MS 16142.

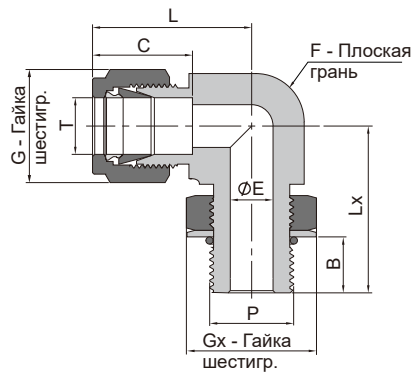

Дюймовая трубка			Прямая резьба SAE/MS								
D нар. трубки T (дюймы)	Размер резьбы P-SAE/MS	Артикул	Размеры, мм (дюймы)								
			L	B	C	G	E	F	Lx	Gx	
1/4	7/16-20	-LP-FL4-ST7	28.4(1.12)	9.9(0.39)	15.2(0.60)	14.3(0.56)	4.8(0.19)	12.7(0.50)	27.0(1.06)	14.3(0.56)	
1/4	9/16-18	-LP-FL4-ST9	30.5(1.20)	11.2(0.44)	15.2(0.60)	14.3(0.56)	4.8(0.19)	15.9(0.63)	32.3(1.27)	17.5(0.69)	
5/16	1/2-20	-LP-FL5-ST8	30.2(1.19)	9.9(0.39)	16.3(0.64)	15.9(0.63)	5.8(0.23)	14.3(0.56)	29.5(1.16)	15.9(0.63)	
3/8	7/16-20	-LP-FL6-ST7	33.3(1.31)	9.9(0.39)	16.8(0.66)	17.5(0.69)	5.1(0.20)	15.9(0.63)	31.5(1.24)	14.3(0.56)	
3/8	9/16-18	-LP-FL6-ST9	32.0(1.26)	11.2(0.44)	16.8(0.66)	17.5(0.69)	7.1(0.28)	15.9(0.63)	32.3(1.27)	17.5(0.69)	
3/8	3/4-16	-LP-FL6-ST12	34.8(1.37)	12.7(0.50)	16.8(0.66)	17.5(0.69)	7.1(0.28)	20.6(0.81)	37.8(1.49)	22.2(0.87)	
1/2	9/16-18	-LP-FL8-ST9	37.6(1.48)	11.2(0.44)	22.9(0.90)	22.2(0.87)	7.1(0.28)	20.6(0.81)	37.5(1.48)	17.5(0.69)	
1/2	3/4-16	-LP-FL8-ST12	37.6(1.48)	12.7(0.50)	22.9(0.90)	22.2(0.87)	10.4(0.41)	20.6(0.81)	37.8(1.49)	22.2(0.87)	
5/8	7/8-14	-LP-FL10-ST14	39.6(1.56)	14.2(0.56)	24.4(0.96)	25.4(1.00)	12.7(0.50)	23.8(0.94)	43.4(1.71)	25.4(1.00)	
3/4	1 1/16-12	-LP-FL12-ST17	41.4(1.63)	16.8(0.66)	24.4(0.96)	28.6(1.13)	15.7(0.62)	27.0(1.06)	48.8(1.92)	31.8(1.25)	
7/8	1 3/16-12	-LP-FL14-ST19	43.2(1.70)	16.8(0.66)	25.9(1.02)	31.8(1.25)	18.3(0.72)	31.8(1.25)	50.5(1.99)	34.9(1.37)	
1	1 5/16-12	-LP-FL16-ST21	50.5(1.99)	16.8(0.66)	31.2(1.23)	38.1(1.50)	22.4(0.88)	34.9(1.37)	53.6(2.11)	38.1(1.50)	
1 1/4	1 5/8-12	-LP-FL20-ST26	67.8(2.67)	16.8(0.66)	41.1(1.62)	47.6(1.87)	27.7(1.09)	42.9(1.69)	58.2(2.29)	47.6(1.87)	
1 1/2	1 7/8-12	-LP-FL24-ST30	78.0(3.07)	16.8(0.66)	50.0(1.97)	57.2(2.25)	34.0(1.34)	50.8(2.00)	60.5(2.38)	54.0(2.13)	

Угольник ввертной 90° с гайкой для позиционирования

Цилиндрическая резьба по ISO

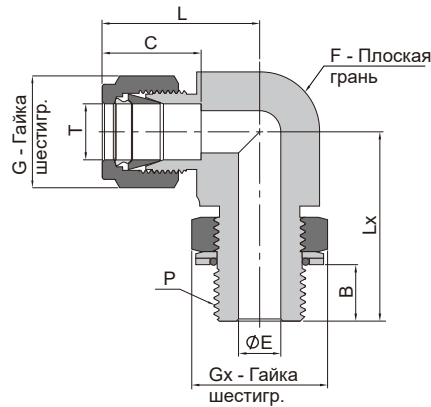

Дюймовая трубка			Цилиндрическая резьба ISO (PP)								
D нар. трубки T (дюймы)	Размер цилиндрической резьбы ISO-P	Артикул	Размеры, мм (дюймы)								
			L	B	C	G	E	F	Lx	Gx	
1/4	1/8	-LP-FL4-PP2	26.9(1.06)	6.6(0.26)	15.2(0.60)	14.3(0.56)	4.1(0.16)	12.7(0.50)	26.4(1.04)	14.3(0.56)	
1/4	1/4	-LP-FL4-PP4	29.0(1.14)	9.0(0.35)	15.2(0.60)	14.3(0.56)	4.8(0.19)	15.9(0.63)	32.3(1.27)	19.1(0.75)	
3/8	1/4	-LP-FL6-PP4	30.5(1.20)	9.0(0.35)	16.8(0.66)	17.5(0.69)	5.8(0.23)	15.9(0.63)	32.3(1.27)	19.1(0.75)	
3/8	3/8	-LP-FL6-PP6	33.3(1.31)	9.4(0.37)	16.8(0.66)	17.5(0.69)	7.1(0.28)	20.6(0.81)	37.1(1.46)	22.2(0.87)	
1/2	1/4	-LP-FL8-PP4	36.1(1.42)	9.0(0.35)	22.9(0.90)	22.2(0.87)	5.8(0.23)	20.6(0.81)	35.1(1.38)	19.1(0.75)	
1/2	3/8	-LP-FL8-PP6	36.1(1.42)	9.4(0.37)	22.9(0.90)	22.2(0.87)	7.9(0.31)	20.6(0.81)	37.1(1.46)	22.2(0.87)	
1/2	1/2	-LP-FL8-PP8	38.1(1.50)	13.0(0.51)	22.9(0.90)	22.2(0.87)	10.4(0.41)	23.8(0.94)	43.4(1.71)	27.0(1.06)	
5/8	1/2	-LP-FL10-PP8	38.1(1.50)	13.0(0.51)	24.4(0.96)	25.4(1.00)	11.9(0.47)	23.8(0.94)	43.4(1.71)	27.0(1.06)	
3/4	1/2	-LP-FL12-PP8	39.9(1.57)	13.0(0.51)	24.4(0.96)	28.6(1.13)	11.9(0.47)	27.0(1.06)	45.2(1.78)	27.0(1.06)	
3/4	3/4	-LP-FL12-PP12	39.9(1.57)	13.0(0.51)	24.4(0.96)	28.6(1.13)	15.7(0.62)	27.0(1.06)	48.8(1.92)	34.9(1.37)	
1	3/4	-LP-FL16-PP12	49.0(1.93)	13.0(0.51)	31.2(1.23)	38.1(1.50)	15.7(0.62)	34.9(1.37)	53.3(2.10)	34.9(1.37)	
1	1	-LP-FL16-PP16	49.0(1.93)	13.2(0.52)	31.2(1.23)	38.1(1.50)	19.8(0.78)	34.9(1.37)	53.6(2.11)	41.3(1.63)	

Метрическая трубка			Цилиндрическая резьба ISO (PP)								
D нар. трубки T (мм)	Размер цилиндрической резьбы ISO-P	Артикул	Размеры, мм (дюймы)								
			L	B	C	G	E	F	Lx	Gx	
6	1/8	-LP-ML6-PP2	27.0(1.06)	6.6(0.26)	15.3(0.60)	14.0(0.55)	4.0(0.16)	12.7(0.50)	26.4(1.04)	14.3(0.56)	
6	1/4	-LP-ML6-PP4	29.0(1.14)	9.0(0.35)	15.3(0.60)	14.0(0.55)	4.8(0.19)	15.9(0.63)	32.3(1.27)	19.1(0.75)	
8	1/8	-LP-ML8-PP2	28.8(1.13)	6.6(0.26)	16.2(0.64)	16.0(0.63)	4.0(0.16)	14.3(0.56)	27.4(1.08)	14.3(0.56)	
8	1/4	-LP-ML8-PP4	29.9(1.18)	9.0(0.35)	16.2(0.64)	16.0(0.63)	5.9(0.23)	15.9(0.63)	32.2(1.27)	19.1(0.75)	
10	1/4	-LP-ML10-PP4	33.5(1.32)	9.0(0.35)	17.2(0.68)	19.0(0.75)	5.9(0.23)	20.6(0.81)	35.0(1.38)	19.1(0.75)	
10	3/8	-LP-ML10-PP6	33.5(1.32)	9.4(0.37)	17.2(0.68)	19.0(0.75)	7.9(0.31)	20.6(0.81)	37.1(1.46)	22.2(0.87)	
12	1/4	-LP-ML12-PP4	36.0(1.42)	9.0(0.35)	22.8(0.90)	22.0(0.87)	5.9(0.23)	20.6(0.81)	35.0(1.38)	19.1(0.75)	
12	3/8	-LP-ML12-PP6	36.0(1.42)	9.4(0.37)	22.8(0.90)	22.0(0.87)	7.9(0.31)	20.6(0.81)	37.1(1.46)	22.2(0.87)	
12	1/2	-LP-ML12-PP8	38.0(1.50)	13.0(0.51)	22.8(0.90)	22.0(0.87)	9.5(0.37)	23.8(0.94)	43.4(1.71)	27.0(1.06)	
12	3/4	-LP-ML12-PP12	39.8(1.57)	13.0(0.51)	22.8(0.90)	22.0(0.87)	9.5(0.37)	27.0(1.06)	48.8(1.92)	34.9(1.37)	

Угольник ввертной 45° с гайкой для позиционирования

Прямая резьба SAE/MS

Совместим с внутренней резьбой SAE J1926-1, ISO 11926-1 и MS 16142.

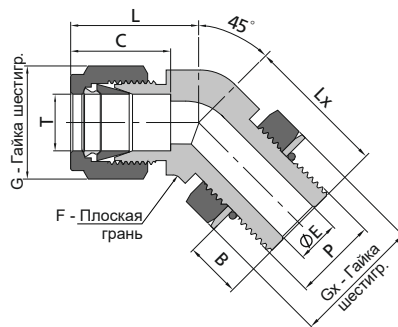

Дюймовая трубка			Прямая резьба SAE/MS								
D нар. трубки T (дюймы)	Размер резьбы P-SAE/MS	Артикул	Размеры, мм (дюймы)								
			L	B	C	G	E	F	Lx	Gx	
1/4	7/16-20	-VP-FL4-ST7	25.7(1.01)	9.9(0.39)	15.2(0.60)	14.3(0.56)	4.8(0.19)	12.7(0.50)	25.7(1.01)	14.3(0.56)	
3/8	9/16-18	-VP-FL6-ST9	27.9(1.10)	11.2(0.44)	16.8(0.66)	17.5(0.69)	7.1(0.28)	15.9(0.63)	28.2(1.11)	17.5(0.69)	
1/2	3/4-16	-VP-FL8-ST12	32.0(1.26)	12.7(0.50)	22.9(0.90)	22.2(0.87)	10.4(0.41)	20.6(0.81)	32.3(1.27)	22.2(0.87)	
3/4	1 1/16-12	-VP-FL12-ST17	39.9(1.57)	16.8(0.66)	24.4(0.96)	28.6(1.13)	15.7(0.62)	27.0(1.06)	47.2(1.86)	31.8(1.25)	
1	1 5/16-12	-VP-FL16-ST21	47.5(1.87)	16.8(0.66)	31.2(1.23)	38.1(1.50)	22.4(0.88)	34.9(1.37)	50.5(1.99)	38.1(1.50)	

Угольник навертной 90°

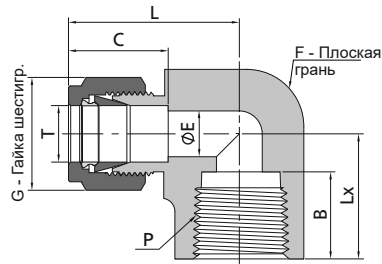

Дюймовая трубка			Резьба NPT						
D нар. трубки T (дюймы)	Размер P-NPT	Артикул	Размеры, мм (дюймы)						
			L	B	C	G	E	F	Lx
1/16	1/16	-LF-FL1-NS1	18.0(0.71)	9.9(0.39)	8.6(0.34)	7.9(0.31)	1.3(0.05)	11.1(0.44)	14.2(0.56)
1/16	1/8	-LF-FL1-NS2	20.6(0.81)	10.4(0.41)	8.6(0.34)	7.9(0.31)	1.3(0.05)	14.3(0.56)	19.1(0.75)
1/8	1/8	-LF-FL2-NS2	24.6(0.97)	10.4(0.41)	12.7(0.50)	11.1(0.44)	2.3(0.09)	12.7(0.50)	19.1(0.75)
1/8	1/4	-LF-FL2-NS4	27.4(1.08)	15.0(0.59)	12.7(0.50)	11.1(0.44)	2.3(0.09)	17.5(0.69)	22.4(0.88)
3/16	1/8	-LF-FL3-NS2	25.4(1.00)	10.4(0.41)	13.7(0.54)	12.7(0.50)	3.0(0.12)	12.7(0.5)	19.1(0.75)
1/4	1/8	-LF-FL4-NS2	26.9(1.06)	10.4(0.41)	15.2(0.60)	14.3(0.56)	4.8(0.19)	12.7(0.50)	19.1(0.75)
1/4	1/4	-LF-FL4-NS4	29.7(1.17)	15.0(0.59)	15.2(0.60)	14.3(0.56)	4.8(0.19)	17.5(0.69)	22.4(0.88)
1/4	3/8	-LF-FL4-NS6	31.8(1.25)	15.0(0.59)	15.2(0.60)	14.3(0.56)	4.8(0.19)	20.6(0.81)	22.4(0.88)
1/4	1/2	-LF-FL4-NS8	34.5(1.36)	19.8(0.78)	15.2(0.60)	14.3(0.56)	4.8(0.19)	25.4(1.00)	28.4(1.12)
5/16	1/8	-LF-FL5-NS2	28.7(1.13)	10.4(0.41)	16.3(0.64)	15.9(0.63)	6.4(0.25)	14.3(0.56)	19.1(0.75)
5/16	1/4	-LF-FL5-NS4	30.5(1.20)	15.0(0.59)	16.3(0.64)	15.9(0.63)	6.4(0.25)	17.5(0.69)	22.4(0.88)
3/8	1/8	-LF-FL6-NS2	30.5(1.20)	10.4(0.41)	16.8(0.66)	17.5(0.69)	7.1(0.28)	15.9(0.63)	19.1(0.75)
3/8	1/4	-LF-FL6-NS4	31.2(1.23)	15.0(0.59)	16.8(0.66)	17.5(0.69)	7.1(0.28)	17.5(0.69)	22.4(0.88)
3/8	3/8	-LF-FL6-NS6	33.3(1.31)	15.0(0.59)	16.8(0.66)	17.5(0.69)	7.1(0.28)	20.6(0.81)	22.4(0.88)
3/8	1/2	-LF-FL6-NS8	36.1(1.42)	19.8(0.78)	16.8(0.66)	17.5(0.69)	7.1(0.28)	25.4(1.00)	28.4(1.12)
1/2	1/4	-LF-FL8-NS4	36.1(1.42)	15.0(0.59)	22.9(0.90)	22.2(0.87)	10.4(0.41)	20.6(0.81)	22.4(0.88)
1/2	3/8	-LF-FL8-NS6	36.1(1.42)	15.0(0.59)	22.9(0.90)	22.2(0.87)	10.4(0.41)	20.6(0.81)	22.4(0.88)
1/2	1/2	-LF-FL8-NS8	38.9(1.53)	19.8(0.78)	22.9(0.90)	22.2(0.87)	10.4(0.41)	25.4(1.00)	28.4(1.12)
5/8	3/8	-LF-FL10-NS6	38.1(1.50)	15.0(0.59)	24.4(0.96)	25.4(1.00)	12.7(0.50)	23.8(0.94)	22.4(0.88)
5/8	1/2	-LF-FL10-NS8	39.9(1.57)	19.8(0.78)	24.4(0.96)	25.4(1.00)	12.7(0.50)	27.0(1.06)	28.4(1.12)
3/4	1/2	-LF-FL12-NS8	39.9(1.57)	19.8(0.78)	24.4(0.96)	28.6(1.13)	15.7(0.62)	27.0(1.06)	28.4(1.12)
3/4	3/4	-LF-FL12-NS12	44.7(1.76)	20.6(0.81)	24.4(0.96)	28.6(1.13)	15.7(0.62)	34.9(1.37)	31.8(1.25)
7/8	3/4	-LF-FL14-NS12	44.7(1.76)	20.6(0.81)	25.9(1.02)	31.8(1.25)	18.3(0.72)	34.9(1.37)	31.8(1.25)
1	3/4	-LF-FL16-NS12	49.0(1.93)	20.6(0.81)	31.2(1.23)	38.1(1.50)	22.4(0.88)	34.9(1.37)	31.8(1.25)
1	1	-LF-FL16-NS16	53.6(2.11)	26.9(1.06)	31.2(1.23)	38.1(1.50)	22.4(0.88)	42.9(1.69)	38.1(1.50)

Метрическая трубка			Резьба NPT						
D нар. трубки T (мм)	Размер P-NPT	Артикул	Размеры, мм (дюймы)						
			L	B	C	G	E	F	Lx
6	1/8	-LF-ML6-NS2	27.0(1.06)	10.4(0.41)	15.3(0.60)	14.0(0.55)	4.8(0.19)	12.7(0.50)	19.0(0.75)
6	1/4	-LF-ML6-NS4	29.8(1.17)	15.0(0.59)	15.3(0.60)	14.0(0.55)	4.8(0.19)	17.5(0.69)	22.4(0.88)
8	1/8	-LF-ML8-NS2	28.8(1.13)	10.4(0.41)	16.2(0.64)	16.0(0.63)	6.4(0.25)	14.3(0.56)	19.1(0.75)
8	1/4	-LF-ML8-NS4	30.6(1.20)	15.0(0.59)	16.2(0.64)	16.0(0.63)	6.4(0.25)	17.5(0.69)	22.4(0.88)
10	1/4	-LF-ML10-NS4	33.5(1.32)	15.0(0.59)	17.2(0.68)	19.0(0.75)	7.9(0.31)	20.6(0.81)	22.4(0.88)
10	3/8	-LF-ML10-NS6	33.5(1.32)	15.0(0.59)	17.2(0.68)	19.0(0.75)	7.9(0.31)	20.6(0.81)	22.4(0.88)
10	1/2	-LF-ML10-NS8	36.6(1.44)	19.8(0.78)	17.2(0.68)	19.0(0.75)	7.9(0.31)	25.4(1.00)	28.5(1.12)
12	1/4	-LF-ML12-NS4	36.0(1.42)	15.0(0.59)	22.8(0.90)	22.0(0.87)	9.5(0.37)	20.6(0.81)	22.4(0.88)
12	3/8	-LF-ML12-NS6	36.0(1.42)	15.0(0.59)	22.8(0.90)	22.0(0.87)	9.5(0.37)	20.6(0.81)	22.4(0.88)
12	1/2	-LF-ML12-NS8	38.8(1.53)	19.8(0.78)	22.8(0.90)	22.0(0.87)	9.5(0.37)	25.4(1.00)	28.4(1.12)
16	3/8	-LF-ML16-NS6	39.5(1.56)	15.0(0.59)	24.4(0.96)	25.0(0.98)	12.7(0.50)	27.0(1.06)	23.6(0.93)
16	1/2	-LF-ML16-NS8	39.5(1.56)	19.8(0.78)	24.4(0.96)	25.0(0.98)	12.7(0.50)	27.0(1.06)	28.5(1.12)

Угольник проходной 90°

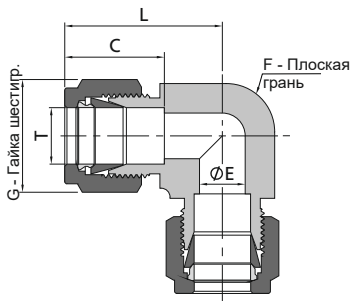

Дюймовая трубка		Размеры, мм (дюймы)				
D нар. трубки T (дюймы)	Артикул	L	C	G	F	E
		1/16	-LU-FL1	17.8(0.70)	8.6(0.34)	7.9(0.31)
1/8	-LU-FL2	22.4(0.88)	12.7(0.50)	11.1(0.44)	9.5(0.37)	2.3(0.09)
3/16	-LU-FL3	25.4(1.00)	13.7(0.54)	12.7(0.50)	12.7(0.50)	3.0(0.12)
1/4	-LU-FL4	26.9(1.06)	15.2(0.60)	14.3(0.56)	12.7(0.50)	4.8(0.19)
5/16	-LU-FL5	28.7(1.13)	16.3(0.64)	15.9(0.63)	14.3(0.56)	6.4(0.25)
3/8	-LU-FL6	30.5(1.20)	16.8(0.66)	17.5(0.69)	15.9(0.63)	7.1(0.28)
1/2	-LU-FL8	36.1(1.42)	22.9(0.90)	22.2(0.87)	20.6(0.81)	10.4(0.41)
5/8	-LU-FL10	38.1(1.50)	24.4(0.96)	25.4(1.00)	23.8(0.94)	12.7(0.5)
3/4	-LU-FL12	39.9(1.57)	24.4(0.96)	28.6(1.13)	27.0(1.06)	15.7(0.62)
7/8	-LU-FL14	44.7(1.76)	25.9(1.02)	31.8(1.25)	34.9(1.37)	18.3(0.72)
1	-LU-FL16	49.0(1.93)	31.2(1.23)	38.1(1.50)	34.9(1.37)	22.4(0.88)
1 1/8	-LU-FL18	66.9(2.63)	36.7(1.44)	44.5(1.75)	42.9(1.69)	24.6(0.97)
1 1/4	-LU-FL20	66.5(2.62)	41.1(1.62)	47.6(1.87)	42.9(1.69)	27.7(1.09)
1 1/2	-LU-FL24	78.0(3.07)	50.0(1.97)	57.2(2.25)	50.8(2.00)	34.0(1.34)

Метрическая трубка		Размеры, мм (дюймы)				
D нар. трубки T (мм)	Артикул	L	C	G	F	E
		3	-LU-ML3	22.3(0.88)	12.9(0.51)	12.0(0.47)
4	-LU-ML4	25.4(1.00)	13.7(0.54)	12.0(0.47)	12.7(0.50)	2.4(0.09)
6	-LU-ML6	27.0(1.06)	15.3(0.60)	14.0(0.55)	12.7(0.50)	4.8(0.19)
8	-LU-ML8	28.8(1.13)	16.2(0.64)	16.0(0.63)	14.3(0.56)	6.4(0.25)
10	-LU-ML10	31.5(1.24)	17.2(0.68)	19.0(0.75)	17.5(0.69)	7.9(0.31)
12	-LU-ML12	36.0(1.42)	22.8(0.90)	22.0(0.87)	20.6(0.81)	9.5(0.37)
14	-LU-ML14	38.0(1.50)	24.4(0.96)	25.0(0.98)	23.8(0.94)	11.0(0.43)
15	-LU-ML15	38.0(1.50)	24.4(0.96)	25.0(0.98)	23.8(0.94)	11.9(0.47)
16	-LU-ML16	38.0(1.50)	24.4(0.96)	25.0(0.98)	23.8(0.94)	12.7(0.50)
18	-LU-ML18	39.8(1.57)	24.4(0.96)	30.0(1.18)	27.0(1.06)	15.1(0.59)
20	-LU-ML20	44.6(1.76)	26.0(1.02)	32.0(1.26)	34.9(1.37)	15.9(0.63)
22	-LU-ML22	44.6(1.76)	26.0(1.02)	32.0(1.26)	34.9(1.37)	18.3(0.72)
25	-LU-ML25	49.1(1.93)	31.3(1.23)	38.0(1.5)	34.9(1.37)	21.8(0.86)
28	-LU-ML28	64.0(2.52)	36.6(1.44)	46.0(1.81)	42.9(1.69)	21.8(0.86)
30	-LU-ML30	69.9(2.75)	39.6(1.56)	50.0(1.97)	42.9(1.69)	26.2(1.03)
32	-LU-ML32	72.3(2.85)	42.0(1.65)	50.0(1.97)	42.9(1.69)	28.6(1.13)
38	-LU-ML38	84.0(3.31)	49.4(1.94)	60.0(2.36)	50.8(2.00)	33.7(1.33)

Угольник переходной 90°

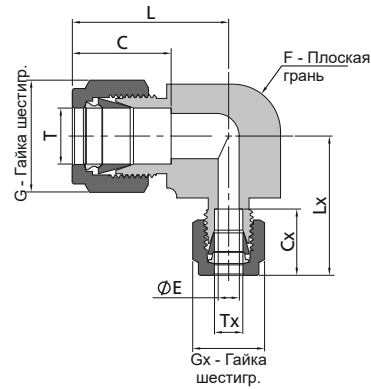

Дюймовая трубка

D нар. трубки Т (дюймы)	D нар. трубки Тх (дюймы)	Артикул	Размеры, мм (дюймы)							
			L	C	G	F	E	Cx	Gx	Lx
3/16	1/8	-LU-FL3-FL2	25.4(1.00)	13.7(0.54)	12.7(0.50)	12.7(0.50)	2.3(0.09)	12.7(0.50)	11.1(0.44)	24.7(0.97)
1/4	1/8	-LU-FL4-FL2	26.9(1.06)	15.2(0.60)	14.3(0.56)	12.7(0.50)	2.3(0.09)	12.7(0.50)	11.1(0.44)	25.4(1.00)
5/16	1/8	-LU-FL5-FL2	29.7(1.17)	16.3(0.64)	15.9(0.63)	14.3(0.56)	2.3(0.09)	12.7(0.50)	11.1(0.44)	26.4(1.04)
5/16	1/4	-LU-FL5-FL4	29.7(1.17)	16.3(0.64)	15.9(0.63)	14.3(0.56)	4.8(0.19)	15.2(0.60)	14.3(0.56)	29.0(1.14)
3/8	1/8	-LU-FL6-FL2	30.5(1.20)	16.8(0.66)	17.5(0.69)	15.9(0.63)	2.3(0.09)	12.7(0.50)	11.1(0.44)	26.4(1.04)
3/8	1/4	-LU-FL6-FL4	30.5(1.20)	16.8(0.66)	17.5(0.69)	15.9(0.63)	4.8(0.19)	15.2(0.60)	14.3(0.56)	29.0(1.14)
3/8	5/16	-LU-FL6-FL5	30.5(1.20)	16.8(0.66)	17.5(0.69)	15.9(0.63)	6.4(0.25)	16.3(0.64)	15.9(0.63)	29.7(1.17)
1/2	1/4	-LU-FL8-FL4	36.1(1.42)	22.9(0.90)	22.2(0.87)	20.6(0.81)	4.8(0.19)	15.2(0.60)	14.3(0.56)	32.2(1.27)
1/2	5/16	-LU-FL8-FL5	36.1(1.42)	22.9(0.90)	22.2(0.87)	20.6(0.81)	6.4(0.25)	16.3(0.64)	15.9(0.63)	32.5(1.28)
1/2	3/8	-LU-FL8-FL6	36.1(1.42)	22.9(0.90)	22.2(0.87)	20.6(0.81)	7.1(0.28)	16.8(0.66)	17.5(0.69)	33.6(1.32)
5/8	3/8	-LU-FL10-FL6	38.1(1.50)	24.4(0.96)	25.4(1.00)	23.8(0.94)	7.1(0.28)	16.8(0.66)	17.5(0.69)	35.6(1.40)
5/8	1/2	-LU-FL10-FL8	38.1(1.50)	24.4(0.96)	25.4(1.00)	23.8(0.94)	10.4(0.41)	22.9(0.90)	22.2(0.87)	38.1(1.50)
3/4	1/4	-LU-FL12-FL4	39.9(1.57)	24.4(0.96)	28.6(1.13)	27.0(1.06)	4.8(0.19)	15.2(0.60)	14.3(0.56)	35.9(1.41)
3/4	3/8	-LU-FL12-FL6	39.9(1.57)	24.4(0.96)	28.6(1.13)	27.0(1.06)	7.1(0.28)	16.8(0.66)	17.5(0.69)	37.4(1.47)
3/4	1/2	-LU-FL12-FL8	39.9(1.57)	24.4(0.96)	28.6(1.13)	27.0(1.06)	10.4(0.41)	22.9(0.90)	22.2(0.87)	39.9(1.57)
7/8	1/4	-LU-FL14-FL4	44.7(1.76)	25.9(1.02)	31.8(1.25)	34.9(1.37)	4.8(0.19)	15.2(0.60)	14.3(0.56)	40.7(1.60)
1	1/2	-LU-FL16-FL8	49.0(1.93)	31.2(1.23)	38.1(1.50)	34.9(1.37)	10.4(0.41)	22.9(0.90)	22.2(0.87)	44.4(1.75)
1	3/4	-LU-FL16-FL12	49.0(1.93)	31.2(1.23)	38.1(1.50)	34.9(1.37)	15.7(0.62)	24.4(0.96)	28.6(1.13)	47.1(1.85)

Метрическая трубка

D нар. трубки Т (мм)	D нар. трубки Тх (мм)	Артикул	Размеры, мм (дюймы)							
			L	C	G	F	E	Cx	Gx	Lx
8	6	-LU-ML8-ML6	28.8(1.13)	16.2(0.64)	16.0(0.63)	14.3(0.56)	4.8(0.19)	15.3(0.60)	14.0(0.55)	27.9(1.10)
10	8	-LU-ML10-ML8	31.5(1.24)	17.2(0.68)	19.0(0.75)	17.5(0.69)	6.4(0.25)	16.2(0.64)	16.0(0.63)	30.5(1.20)
12	8	-LU-ML12-ML8	36.0(1.42)	22.8(0.90)	22.0(0.87)	20.6(0.81)	6.4(0.25)	16.2(0.64)	16.0(0.63)	32.6(1.28)
14	8	-LU-ML14-ML8	38.8(1.53)	24.4(0.96)	25.0(0.98)	23.8(0.94)	6.4(0.25)	16.2(0.64)	16.0(0.63)	34.7(1.37)
14	10	-LU-ML14-ML10	38.8(1.53)	24.4(0.96)	25.0(0.98)	23.8(0.94)	7.9(0.31)	17.2(0.68)	19.0(0.75)	35.5(1.40)

Угольник проходной 90° с монтажной гайкой

Обжимные
фитинги

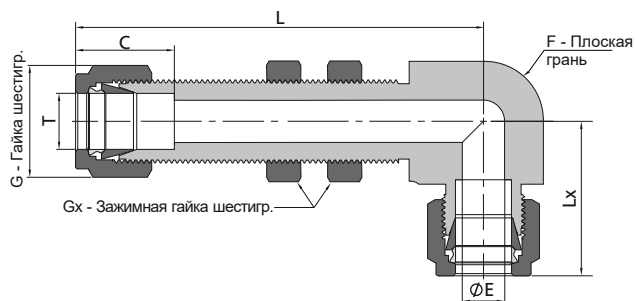

Дюймовая трубка		Размеры, мм (дюймы)							Размер отверстия панели, мм (дюймы)	Макс. толщина панели, мм (дюймы)
D нар. трубки T (дюймы)	Артикул	L	C	E	G	F	Lx	Gx		
1/8	-BBLU-FL2	49.0(1.93)	12.7(0.50)	2.3(0.09)	11.1(0.44)	9.5(0.37)	22.4(0.88)	12.7(0.50)	8.3(0.33)	15.2(0.60)
3/16	-BBLU-FL3	51.6(2.03)	13.7(0.54)	3.0(0.12)	12.7(0.50)	12.7(0.50)	25.4(1.00)	14.3(0.56)	9.9(0.39)	15.5(0.61)
1/4	-BBLU-FL4	53.3(2.10)	15.2(0.60)	4.8(0.19)	14.3(0.56)	12.7(0.50)	26.9(1.06)	15.9(0.63)	11.5(0.45)	15.5(0.61)
5/6	-BBLU-FL5	58.4(2.30)	16.3(0.64)	6.4(0.25)	15.9(0.63)	15.9(0.63)	28.7(1.13)	17.5(0.69)	13.1(0.52)	18.8(0.74)
3/8	-BBLU-FL6	59.9(2.36)	16.8(0.66)	7.1(0.28)	15.7(0.69)	15.9(0.63)	30.5(1.20)	19.1(0.75)	14.7(0.58)	18.8(0.74)
1/2	-BBLU-FL8	67.8(2.67)	22.9(0.90)	10.4(0.41)	22.2(0.87)	20.6(0.81)	36.1(1.42)	23.8(0.94)	19.4(0.76)	18.8(0.74)
5/8	-BBLU-FL10	71.6(2.82)	24.4(0.96)	12.7(0.50)	25.4(1.00)	23.8(0.94)	38.1(1.50)	27.0(1.06)	22.6(0.89)	12.7(0.50)
3/4	-BBLU-FL12	78.2(3.08)	24.4(0.96)	12.7(0.62)	28.6(1.13)	27.0(1.06)	39.9(1.57)	30.2(1.19)	25.0(1.02)	16.8(0.66)

Тройник симметричный ввертной

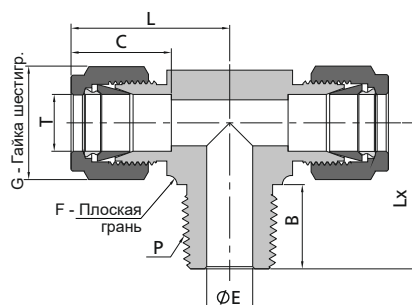

Дюймовая трубка			Резьба NPT							
D нар. трубки T (дюймы)	Размер P-NPT	Артикул	Размеры, мм (дюймы)							
			L	C	G	F	E	B	Lx	
1/8	1/8	-TTM-FL2-NS2	23.6(0.93)	12.7(0.50)	11.1(0.44)	11.1(0.44)	2.3(0.09)	9.7(0.38)	17.8(0.70)	
1/8	1/4	-TTM-FL2-NS4	24.6(0.97)	12.7(0.50)	11.1(0.44)	12.7(0.50)	2.3(0.09)	14.2(0.56)	23.4(0.92)	
3/16	1/8	-TTM-FL3-NS2	24.4(0.96)	13.7(0.54)	12.7(0.50)	11.1(0.44)	3.0(0.12)	9.7(0.38)	17.8(0.70)	
1/4	1/8	-TTM-FL4-NS2	26.9(1.06)	15.2(0.60)	14.3(0.56)	12.7(0.50)	4.8(0.19)	9.7(0.38)	18.8(0.74)	
1/4	1/4	-TTM-FL4-NS4	26.9(1.06)	15.2(0.60)	14.3(0.56)	12.7(0.50)	4.8(0.19)	14.2(0.56)	23.4(0.92)	
5/16	1/8	-TTM-FL5-NS2	29.7(1.17)	16.3(0.64)	15.9(0.63)	15.9(0.63)	4.8(0.19)	9.7(0.38)	20.8(0.82)	
5/16	1/4	-TTM-FL5-NS4	29.7(1.17)	16.3(0.64)	15.9(0.63)	15.9(0.63)	6.4(0.25)	14.2(0.56)	25.7(1.01)	
3/8	1/4	-TTM-FL6-NS4	30.5(1.20)	16.8(0.66)	17.5(0.69)	15.9(0.63)	7.1(0.28)	14.2(0.56)	25.4(1.00)	
3/8	3/8	-TTM-FL6-NS6	33.3(1.31)	16.8(0.66)	17.5(0.69)	20.6(0.81)	7.1(0.28)	14.2(0.56)	28.2(1.11)	
1/2	3/8	-TTM-FL8-NS6	36.1(1.42)	22.9(0.90)	22.2(0.87)	20.6(0.81)	9.7(0.38)	14.2(0.56)	28.2(1.11)	
1/2	1/2	-TTM-FL8-NS8	36.1(1.42)	22.9(0.90)	22.2(0.87)	20.6(0.81)	10.4(0.41)	19.1(0.75)	33.0(1.30)	
5/8	1/2	-TTM-FL10-NS8	38.9(1.53)	24.4(0.96)	25.4(1.00)	25.4(1.00)	11.9(0.47)	19.1(0.75)	35.8(1.41)	
3/4	3/4	-TTM-FL12-NS12	39.9(1.57)	24.4(0.96)	28.6(1.13)	27.0(1.06)	15.7(0.62)	19.1(0.75)	36.8(1.45)	
7/8	3/4	-TTM-FL14-NS12	47.8(1.88)	25.9(1.02)	31.8(1.25)	34.9(1.37)	15.7(0.62)	19.1(0.75)	47.5(1.87)	
1	3/4	-TTM-FL16-NS12	49.3(1.94)	31.2(1.23)	38.1(1.50)	34.9(1.37)	15.7(0.62)	19.1(0.75)	47.5(1.87)	
1	1	-TTM-FL16-NS16	49.3(1.94)	31.2(1.23)	38.1(1.50)	34.9(1.37)	22.4(0.88)	23.9(0.94)	46.7(1.84)	

Метрическая трубка			Резьба NPT							
D нар. трубки T (мм)	Размер P-NPT	Артикул	Размеры, мм (дюймы)							
			L	C	G	F	E	B	Lx	
6	1/8	-TTM-ML6-NS2	27.0(1.06)	15.3(0.60)	14.0(0.55)	12.7(0.50)	4.8(0.19)	9.7(0.38)	18.8(0.74)	
6	1/4	-TTM-ML6-NS4	27.0(1.06)	15.3(0.60)	14.0(0.55)	12.7(0.50)	4.8(0.19)	14.2(0.56)	23.4(0.92)	
8	1/8	-TTM-ML8-NS2	29.9(1.18)	16.2(0.64)	16.0(0.63)	15.9(0.63)	4.8(0.19)	9.7(0.38)	20.8(0.82)	
8	1/4	-TTM-ML8-NS4	29.9(1.18)	16.2(0.64)	16.0(0.63)	15.9(0.63)	6.4(0.25)	14.2(0.56)	25.4(1.00)	
10	1/4	-TTM-ML10-NS4	33.5(1.32)	17.2(0.68)	19.0(0.75)	20.6(0.81)	7.1(0.28)	14.2(0.56)	28.2(1.11)	
10	3/8	-TTM-ML10-NS6	33.5(1.32)	17.2(0.68)	19.0(0.75)	20.6(0.81)	7.9(0.31)	14.2(0.56)	28.2(1.11)	
12	1/4	-TTM-ML12-NS4	36.0(1.42)	22.8(0.90)	22.0(0.87)	20.6(0.81)	7.1(0.28)	14.2(0.56)	28.2(1.11)	
12	3/8	-TTM-ML12-NS6	36.0(1.42)	22.8(0.90)	22.0(0.87)	20.6(0.81)	9.5(0.37)	14.2(0.56)	28.2(1.11)	
12	1/2	-TTM-ML12-NS8	36.0(1.42)	22.8(0.90)	22.0(0.87)	20.6(0.81)	9.5(0.37)	19.1(0.75)	33.0(1.30)	
16	1/2	-TTM-ML16-NS8	38.8(1.53)	24.4(0.96)	25.0(0.98)	25.4(1.00)	11.9(0.47)	19.1(0.75)	35.8(1.41)	

Тройник ввертной с боковым отводом

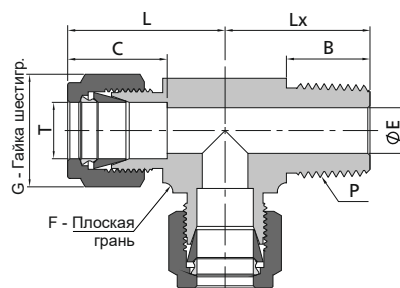

Дюймовая трубка			Резьба NPT						
D нар. трубки T (дюймы)	Размер P-NPT	Артикул	Размеры, мм (дюймы)						
			L	C	G	F	E	B	Lx
1/8	1/8	-TMT-FL2-NS2	23.6(0.93)	12.7(0.50)	11.1(0.44)	11.1(0.44)	2.3(0.09)	9.7(0.38)	17.8(0.70)
1/8	1/4	-TMT-FL2-NS4	24.6(0.97)	12.7(0.50)	11.1(0.44)	12.7(0.50)	2.3(0.09)	14.2(0.56)	23.4(0.92)
3/16	1/8	-TMT-FL3-NS2	24.4(0.96)	13.7(0.54)	12.7(0.50)	11.1(0.44)	3.0(0.12)	9.7(0.38)	17.8(0.70)
1/4	1/8	-TMT-FL4-NS2	26.9(1.06)	15.2(0.60)	14.3(0.56)	12.7(0.50)	4.8(0.19)	9.7(0.38)	18.8(0.74)
1/4	1/4	-TMT-FL4-NS4	26.9(1.06)	15.2(0.60)	14.3(0.56)	12.7(0.50)	4.8(0.19)	14.2(0.56)	23.4(0.92)
5/16	1/8	-TMT-FL5-NS2	29.7(1.17)	16.3(0.64)	15.9(0.63)	15.9(0.63)	4.8(0.19)	9.7(0.38)	20.8(0.82)
5/16	1/4	-TMT-FL5-NS4	29.7(1.17)	16.3(0.64)	15.9(0.63)	15.9(0.63)	6.4(0.25)	14.2(0.56)	25.7(1.01)
3/8	1/4	-TMT-FL6-NS4	30.5(1.20)	16.8(0.66)	17.5(0.69)	15.9(0.63)	7.1(0.28)	14.2(0.56)	25.4(1.00)
3/8	3/8	-TMT-FL6-NS6	33.3(1.31)	16.8(0.66)	17.5(0.69)	20.6(0.81)	7.1(0.28)	14.2(0.56)	28.2(1.11)
1/2	3/8	-TMT-FL8-NS6	36.1(1.42)	22.9(0.90)	22.2(0.87)	20.6(0.81)	9.7(0.38)	14.2(0.56)	28.2(1.11)
1/2	1/2	-TMT-FL8-NS8	36.1(1.42)	22.9(0.90)	22.2(0.87)	20.6(0.81)	10.4(0.41)	19.1(0.75)	33.0(1.3)
5/8	1/2	-TMT-FL10-NS8	38.1(1.50)	24.4(0.96)	25.4(1.00)	23.8(0.94)	11.9(0.47)	19.1(0.75)	35.8(1.41)
3/4	3/4	-TMT-FL12-NS12	39.9(1.57)	24.4(0.96)	28.6(1.13)	27.0(1.06)	15.7(0.62)	19.1(0.75)	36.8(1.45)
7/8	3/4	-TMT-FL14-NS12	47.8(1.88)	25.9(1.02)	31.8(1.25)	34.9(1.37)	15.7(0.62)	19.1(0.75)	47.5(1.87)
1	3/4	-TMT-FL16-NS12	49.3(1.94)	31.2(1.23)	38.1(1.50)	34.9(1.37)	15.7(0.62)	19.1(0.75)	47.5(1.87)
1	1	-TMT-FL16-NS16	49.3(1.94)	31.2(1.23)	38.1(1.50)	34.9(1.37)	22.4(0.88)	23.9(0.94)	46.7(1.84)

Метрическая трубка			Резьба NPT						
D нар. трубки T (мм)	Размер P-NPT	Артикул	Размеры, мм (дюймы)						
			L	C	G	F	E	B	Lx
6	1/8	-TMT-ML6-NS2	27.0(1.06)	15.3(0.60)	14.0(0.55)	12.7(0.50)	4.8(0.19)	9.7(0.38)	18.0(0.71)
6	1/4	-TMT-ML6-NS4	27.0(1.06)	15.3(0.60)	14.0(0.55)	12.7(0.50)	4.8(0.19)	14.2(0.56)	23.4(0.92)
8	1/8	-TMT-ML8-NS2	29.9(1.18)	16.2(0.64)	16.0(0.63)	15.9(0.63)	4.8(0.19)	9.7(0.38)	20.8(0.82)
8	1/4	-TMT-ML8-NS4	29.9(1.18)	16.2(0.64)	16.0(0.63)	15.9(0.63)	6.4(0.25)	14.2(0.56)	25.4(1.00)
10	1/4	-TMT-ML10-NS4	33.5(1.32)	17.2(0.68)	19.0(0.75)	20.6(0.81)	7.1(0.28)	14.2(0.56)	28.2(1.11)
10	1/2	-TMT-ML10-NS8	33.5(1.32)	17.2(0.68)	19.0(0.75)	20.6(0.81)	7.9(0.31)	19.1(0.75)	33.0(1.3)
12	1/4	-TMT-ML12-NS4	36.0(1.42)	22.8(0.90)	22.0(0.87)	20.6(0.81)	7.1(0.28)	14.2(0.56)	28.2(1.11)
12	3/8	-TMT-ML12-NS6	36.0(1.42)	22.8(0.90)	22.0(0.87)	20.6(0.81)	9.5(0.37)	14.2(0.56)	28.2(1.11)
12	1/2	-TMT-ML12-NS8	36.0(1.42)	22.8(0.90)	22.0(0.87)	20.6(0.81)	9.5(0.37)	19.1(0.75)	33.0(1.30)
16	1/2	-TMT-ML16-NS8	38.0(1.50)	24.4(0.96)	25.0(0.98)	23.8(0.94)	11.9(0.47)	19.1(0.75)	35.0(1.38)

Тройник симметричный ввертной с гайкой для позиционирования

Прямая резьба SAE/MS

Совместим с внутренней резьбой SAE J1926-1, ISO 11926-1 и MS 16142.

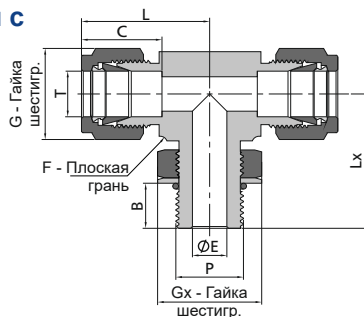

Дюймовая трубка			Прямая резьба SAE/MS							
D нар. трубки T (дюймы)	Размер резьбы P-SAE/MS	Артикул	Размеры, мм (дюймы)							
			L	B	C	E	G	F	Lx	Gx
1/4	7/16-20	-TTP-FL4-ST7	28.5(1.12)	9.9(0.39)	15.2(0.60)	4.8(0.19)	14.3(0.56)	12.7(0.50)	27.0(1.06)	14.3(0.56)
3/8	9/16-18	-TTP-FL6-ST9	32.0(1.26)	11.2(0.44)	16.8(0.66)	7.1(0.28)	17.5(0.69)	15.9(0.63)	32.3(1.27)	17.5(0.69)
1/2	3/4-16	-TTP-FL8-ST12	37.6(1.48)	12.7(0.50)	22.9(0.90)	10.4(0.41)	22.2(0.87)	20.6(0.81)	37.8(1.49)	22.2(0.87)
3/4	1 1/16-12	-TTP-FL12-ST17	41.4(1.63)	16.8(0.66)	24.4(0.96)	15.7(0.62)	28.6(1.13)	27.0(1.06)	48.8(1.92)	31.8(1.25)
1	1 5/16-12	-TTP-FL16-ST21	50.5(1.99)	16.8(0.66)	31.2(1.23)	22.4(0.88)	38.1(1.50)	34.9(1.37)	53.6(2.11)	38.1(1.50)
1 1/4	1 5/8-12	-TTP-FL20-ST26	67.8(2.67)	16.8(0.66)	41.1(1.62)	27.7(1.09)	47.6(1.87)	42.9(1.69)	58.2(2.29)	47.6(1.87)
1 1/2	1 7/8-12	-TTP-FL24-ST30	78.0(3.07)	16.8(0.66)	50.0(1.97)	34.0(1.34)	57.2(2.25)	50.8(2.00)	60.5(2.38)	54.0(2.13)

Тройник симметричный ввертной с гайкой для позиционирования

Цилиндрическая резьба ISO

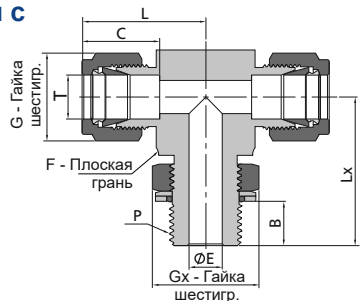

Дюймовая трубка			Цилиндрическая резьба ISO (PP)							
D нар. трубки T (дюймы)	Размер параллельной резьбы P-ISO	Артикул	Размеры, мм (дюймы)							
			L	B	C	E	G	F	Lx	Gx
1/4	1/8	-TTP-FL4-PP2	26.9(1.06)	6.6(0.26)	15.2(0.60)	4.1(0.16)	14.3(0.56)	12.7(0.50)	26.4(1.04)	14.3(0.56)
1/4	1/4	-TTP-FL4-PP4	29.0(1.14)	9.0(0.35)	15.2(0.60)	4.8(0.19)	14.3(0.56)	15.9(0.63)	32.3(1.27)	19.1(0.75)
3/8	1/4	-TTP-FL6-PP4	30.5(1.20)	9.0(0.35)	16.8(0.66)	5.8(0.23)	17.5(0.69)	15.9(0.63)	32.3(1.27)	19.1(0.75)
1/2	3/8	-TTP-FL8-PP6	36.1(1.42)	9.4(0.37)	22.9(0.90)	7.9(0.31)	22.2(0.87)	20.6(0.81)	37.1(1.46)	22.2(0.87)
1/2	1/2	-TTP-FL8-PP8	38.1(1.50)	13.0(0.51)	22.9(0.90)	10.4(0.41)	22.2(0.87)	23.8(0.94)	43.4(1.71)	27.0(1.06)
5/8	1/2	-TTP-FL10-PP8	38.1(1.50)	13.0(0.51)	24.4(0.96)	11.9(0.47)	25.4(1.00)	23.8(0.94)	43.4(1.71)	27.0(1.06)
3/4	1/2	-TTP-FL12-PP8	39.9(1.57)	13.0(0.51)	24.4(0.96)	11.9(0.47)	28.6(1.13)	27.0(1.06)	45.2(1.78)	27.0(1.06)
3/4	3/4	-TTP-FL12-PP12	39.9(1.57)	13.0(0.51)	24.4(0.96)	15.7(0.62)	28.6(1.13)	27.0(1.06)	48.8(1.92)	34.9(1.37)
1	1	-TTP-FL16-PP16	49.0(1.93)	13.2(0.52)	31.2(1.23)	19.8(0.78)	38.1(1.50)	34.9(1.37)	53.6(2.11)	41.3(1.63)

Метрическая трубка			Цилиндрическая резьба ISO (PP)							
D нар. трубки T (мм)	Размер параллельной резьбы P-ISO	Артикул	Размеры, мм (дюймы)							
			L	B	C	E	G	F	Lx	Gx
6	1/8	-TTP-ML6-PP2	27.0(1.06)	6.6(0.26)	15.3(0.60)	4.0(0.16)	14.0(0.55)	12.7(0.50)	26.4(1.04)	14.3(0.56)
6	1/4	-TTP-ML6-PP4	29.0(1.14)	9.0(0.35)	15.3(0.60)	4.8(0.19)	14.0(0.55)	15.9(0.63)	32.2(1.27)	19.1(0.75)
8	1/8	-TTP-ML8-PP2	28.8(1.13)	6.6(0.26)	16.2(0.64)	4.0(0.16)	16.0(0.63)	14.3(0.56)	27.5(1.08)	14.3(0.56)
8	1/4	-TTP-ML8-PP4	29.9(1.18)	9.0(0.35)	16.2(0.64)	5.9(0.23)	16.0(0.63)	15.9(0.63)	32.2(1.27)	19.1(0.75)
10	1/4	-TTP-ML10-PP4	33.5(1.32)	9.0(0.35)	17.2(0.68)	5.9(0.23)	19.0(0.75)	20.6(0.81)	35.1(1.38)	19.1(0.75)
12	3/8	-TTP-ML12-PP6	36.0(1.42)	9.4(0.37)	22.8(0.90)	7.9(0.31)	22.0(0.87)	20.6(0.81)	37.1(1.46)	22.2(0.87)
12	1/2	-TTP-ML12-PP8	38.0(1.50)	13.0(0.51)	22.8(0.90)	9.5(0.37)	22.0(0.87)	23.8(0.94)	43.5(1.71)	27.0(1.06)

Тройник ввертной с боковым отводом с гайкой для позиционирования

Прямая резьба SAE/MS

Совместим с внутренней резьбой SAE J1926-1, ISO 11926-1 и MS 16142.

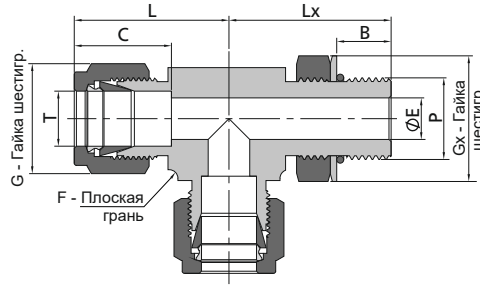

Дюймовая трубка			Прямая резьба SAE/MS							
D нар. трубки T (дюймы)	Размер резьбы P-SAE/MS	Артикул	Размеры, мм (дюймы)							
			L	B	C	E	G	F	Lx	Gx
1/4	7/16-20	-TPT-FL4-ST7	28.5(1.12)	9.9(0.39)	15.2(0.60)	4.8(0.19)	14.3(0.56)	12.7(0.50)	27.0(1.06)	14.3(0.56)
3/8	9/16-18	-TPT-FL6-ST9	32.0(1.26)	11.2(0.44)	16.8(0.66)	7.1(0.28)	17.5(0.69)	15.9(0.63)	32.3(1.27)	17.5(0.69)
1/2	3/4-16	-TPT-FL8-ST12	37.6(1.48)	12.7(0.50)	22.9(0.90)	10.4(0.41)	22.2(0.87)	20.6(0.81)	37.8(1.49)	22.2(0.87)
3/4	1 1/16-12	-TPT-FL12-ST17	41.4(1.63)	16.8(0.66)	24.4(0.96)	15.7(0.62)	31.75(1.25)	27.0(1.06)	48.8(1.92)	31.8(1.25)
1	1 5/16-12	-TPT-FL16-ST21	50.5(1.99)	16.8(0.66)	31.2(1.23)	22.4(0.88)	38.1(1.50)	34.9(1.37)	53.6(2.11)	38.1(1.50)
1 1/4	1 5/8-12	-TPT-FL20-ST26	67.8(2.67)	16.8(0.66)	41.1(1.62)	27.7(1.09)	47.6(1.87)	42.9(1.69)	58.2(2.29)	47.6(1.87)
1 1/2	1 7/8-12	-TPT-FL24-ST30	78.0(3.07)	16.8(0.66)	50.0(1.97)	34.0(1.34)	57.2(2.25)	50.8(2.00)	60.5(2.38)	54.0(2.13)

Тройник ввертной с боковым отводом с гайкой для позиционирования

Цилиндрическая резьба ISO

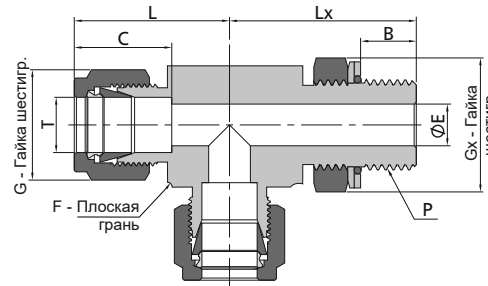

Дюймовая трубка			Цилиндрическая резьба ISO (PP)							
D нар. трубки T (дюймы)	Размер параллельной резьбы P-ISO	Артикул	Размеры, мм (дюймы)							
			L	B	C	E	G	F	Lx	Gx
1/4	1/8	-TPT-FL4-PP2	26.9(1.06)	6.6(0.26)	15.2(0.60)	4.1(0.16)	14.3(0.56)	12.7(0.50)	26.4(1.04)	14.3(0.56)
1/4	1/4	-TPT-FL4-PP4	29.0(1.14)	9.0(0.35)	15.2(0.60)	4.8(0.19)	14.3(0.56)	15.9(0.63)	32.3(1.27)	19.1(0.75)
3/8	1/4	-TPT-FL6-PP4	30.5(1.20)	9.0(0.35)	16.8(0.66)	5.8(0.23)	17.5(0.69)	15.9(0.63)	32.3(1.27)	19.1(0.75)
1/2	3/8	-TPT-FL8-PP6	36.1(1.42)	9.4(0.37)	22.9(0.90)	7.9(0.31)	22.2(0.87)	20.6(0.81)	37.1(1.46)	22.2(0.87)
1/2	1/2	-TPT-FL8-PP8	38.1(1.50)	13.0(0.51)	22.9(0.90)	10.4(0.41)	22.2(0.87)	23.8(0.94)	43.4(1.71)	27.0(1.06)
5/8	1/2	-TPT-FL10-PP8	38.1(1.50)	13.0(0.51)	24.4(0.96)	11.9(0.47)	25.4(1.00)	23.8(0.94)	43.4(1.71)	27.0(1.06)
3/4	1/2	-TPT-FL12-PP8	39.9(1.57)	13.0(0.51)	24.4(0.96)	11.9(0.47)	28.6(1.13)	27.0(1.06)	45.2(1.78)	27.0(1.06)
3/4	3/4	-TPT-FL12-PP12	39.9(1.57)	13.0(0.51)	24.4(0.96)	15.7(0.62)	28.6(1.13)	27.0(1.06)	48.8(1.92)	34.9(1.37)
1	1	-TPT-FL16-PP16	49.0(1.93)	13.2(0.52)	31.2(1.23)	19.8(0.78)	38.1(1.50)	34.9(1.37)	53.6(2.11)	41.3(1.63)

Метрическая трубка			Цилиндрическая резьба ISO (PP)							
D нар. трубки T (мм)	Размер параллельной резьбы P-ISO	Артикул	Размеры, мм (дюймы)							
			L	B	C	E	G	F	Lx	Gx
6	1/8	-TPT-ML6-PP2	27.0(1.06)	6.6(0.26)	15.3(0.60)	4.0(0.16)	14.0(0.55)	12.7(0.50)	26.4(1.04)	14.3(0.56)
6	1/4	-TPT-ML6-PP4	29.0(1.14)	9.0(0.35)	15.3(0.60)	4.8(0.19)	14.0(0.55)	15.9(0.63)	32.2(1.27)	19.1(0.75)
8	1/8	-TPT-ML8-PP2	28.8(1.13)	6.6(0.26)	16.2(0.64)	4.0(0.16)	16.0(0.63)	14.3(0.56)	27.5(1.08)	14.3(0.56)
8	1/4	-TPT-ML8-PP4	29.9(1.18)	9.0(0.35)	16.2(0.64)	5.9(0.23)	16.0(0.63)	15.9(0.63)	32.2(1.27)	19.1(0.75)
10	1/4	-TPT-ML10-PP4	33.5(1.32)	9.0(0.35)	17.2(0.68)	5.9(0.23)	19.0(0.75)	20.6(0.81)	35.1(1.38)	19.1(0.75)
12	3/8	-TPT-ML12-PP6	36.0(1.42)	9.4(0.37)	22.8(0.90)	7.9(0.31)	22.0(0.87)	20.6(0.81)	37.1(1.46)	22.2(0.87)
12	1/2	-TPT-ML12-PP8	38.0(1.50)	13.0(0.51)	22.8(0.90)	9.5(0.37)	22.0(0.87)	23.8(0.94)	43.5(1.71)	27.0(1.06)

Тройник симметричный навертной

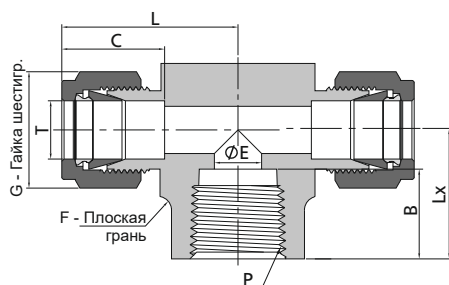

Дюймовая трубка			Резьба NPT						
D нар. трубки T (дюймы)	Размер P-NPT	Артикул	Размеры, мм (дюймы)						
			L	C	G	F	E	B	Lx
1/8	1/8	-TTF-FL2-NS2	24.6(0.97)	12.7(0.50)	11.1(0.44)	12.7(0.50)	2.3(0.09)	10.4(0.41)	19.1(0.75)
3/16	1/8	-TTF-FL3-NS2	25.7(1.01)	13.7(0.54)	12.7(0.50)	12.7(0.50)	3.0(0.12)	10.4(0.41)	19.1(0.75)
1/4	1/8	-TTF-FL4-NS2	26.9(1.06)	15.2(0.60)	14.3(0.56)	12.7(0.50)	4.8(0.19)	10.4(0.41)	19.1(0.75)
1/4	1/4	-TTF-FL4-NS4	29.7(1.17)	15.2(0.60)	14.3(0.56)	17.5(0.69)	4.8(0.19)	15.0(0.59)	22.4(0.88)
5/16	1/8	-TTF-FL5-NS2	29.7(1.17)	16.2(0.64)	15.9(0.63)	15.9(0.63)	6.4(0.25)	10.4(0.41)	19.1(0.75)
3/8	1/4	-TTF-FL6-NS4	31.2(1.23)	16.8(0.66)	17.5(0.69)	17.5(0.69)	7.1(0.28)	15.0(0.59)	22.4(0.88)
3/8	3/8	-TTF-FL6-NS6	33.3(1.31)	16.8(0.66)	17.5(0.69)	20.6(0.81)	7.1(0.28)	15.0(0.59)	22.4(0.88)
3/8	1/2	-TTF-FL6-NS8	36.1(1.42)	16.8(0.66)	17.5(0.69)	25.4(1.00)	7.1(0.28)	19.8(0.78)	28.4(1.12)
1/2	1/4	-TTF-FL8-NS4	36.1(1.42)	22.9(0.90)	22.2(0.87)	20.6(0.81)	10.4(0.41)	15.0(0.59)	22.4(0.88)
1/2	3/8	-TTF-FL8-NS6	36.1(1.42)	22.9(0.90)	22.2(0.87)	20.6(0.81)	10.4(0.41)	15.0(0.59)	22.4(0.88)
1/2	1/2	-TTF-FL8-NS8	38.9(1.53)	22.9(0.90)	22.2(0.87)	25.4(1.00)	10.4(0.41)	19.8(0.78)	28.4(1.12)
5/8	1/2	-TTF-FL10-NS8	38.9(1.53)	24.4(0.96)	25.4(1.00)	25.4(1.00)	12.7(0.50)	19.8(0.78)	28.4(1.12)
3/4	3/4	-TTF-FL12-NS12	44.7(1.76)	24.4(0.96)	28.6(1.13)	34.9(1.37)	15.7(0.62)	20.6(0.81)	31.8(1.25)
7/8	3/4	-TTF-FL14-NS12	44.7(1.76)	25.9(1.02)	31.8(1.25)	34.9(1.37)	18.3(0.72)	20.6(0.81)	31.8(1.25)
1	3/4	-TTF-FL16-NS12	49.0(1.93)	31.2(1.23)	38.1(1.50)	34.9(1.37)	22.4(0.88)	20.6(0.81)	31.8(1.25)
1	1	-TTF-FL16-NS16	53.6(2.11)	31.2(1.23)	38.1(1.50)	42.9(1.69)	22.4(0.88)	25.4(1.00)	38.1(1.50)

Метрическая трубка			Резьба NPT						
D нар. трубки T (мм)	Размер P-NPT	Артикул	Размеры, мм (дюймы)						
			L	C	G	F	E	B	Lx
6	1/8	-TTF-ML6-NS2	27.0(1.06)	15.3(0.60)	14.0(0.55)	12.7(0.50)	4.8(0.19)	10.4(0.41)	19.0(0.75)
6	1/4	-TTF-ML6-NS4	29.8(1.17)	15.3(0.60)	14.0(0.55)	17.5(0.69)	4.8(0.19)	15.0(0.59)	22.4(0.88)
8	1/8	-TTF-ML8-NS2	29.9(1.18)	16.2(0.64)	16.0(0.63)	15.9(0.63)	6.4(0.25)	10.4(0.41)	19.0(0.75)
8	1/4	-TTF-ML8-NS4	30.6(1.2)	16.2(0.64)	16.0(0.63)	17.5(0.69)	6.4(0.25)	15.0(0.59)	22.4(0.88)
10	1/4	-TTF-ML10-NS4	33.5(1.32)	17.2(0.68)	19.0(0.75)	20.6(0.81)	7.9(0.31)	15.0(0.59)	22.4(0.88)
12	1/8	-TTF-ML12-NS2	36.0(1.42)	22.8(0.90)	22.0(0.87)	20.6(0.81)	6.4(0.25)	10.4(0.41)	22.3(0.88)
12	1/4	-TTF-ML12-NS4	36.0(1.42)	22.8(0.90)	22.0(0.87)	20.6(0.81)	9.5(0.37)	15.0(0.59)	22.4(0.88)
12	3/8	-TTF-ML12-NS6	36.0(1.42)	22.8(0.90)	22.0(0.87)	20.6(0.81)	9.5(0.37)	15.0(0.59)	22.4(0.88)
12	1/2	-TTF-ML12-NS8	38.8(1.53)	22.8(0.90)	22.0(0.87)	25.4(1.00)	9.5(0.37)	19.8(0.78)	28.5(1.12)
16	1/2	-TTF-ML16-NS8	38.8(1.53)	24.4(0.96)	25.0(0.98)	25.4(1.00)	12.7(0.50)	19.8(0.78)	28.4(1.12)

Тройник наворотной с боковым отводом

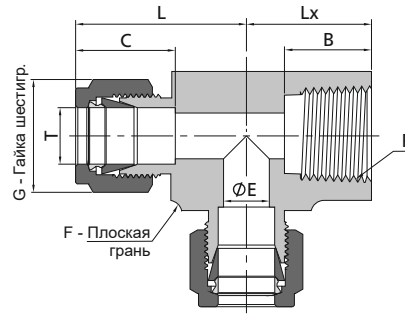

Дюймовая трубка			Резьба NPT						
D нар. трубки T (дюймы)	Размер P-NPT	Артикул	Размеры, мм (дюймы)						
			L	C	G	F	E	B	Lx
1/8	1/8	-TFT-FL2-NS2	24.6(0.97)	12.7(0.50)	11.1(0.44)	12.7(0.50)	2.3(0.09)	10.4(0.41)	19.1(0.75)
3/16	1/8	-TFT-FL3-NS2	25.7(1.01)	13.7(0.54)	12.7(0.50)	12.7(0.50)	3.0(0.12)	10.4(0.41)	19.1(0.75)
1/4	1/8	-TFT-FL4-NS2	26.9(1.06)	15.2(0.60)	14.3(0.56)	12.7(0.50)	4.8(0.19)	10.4(0.41)	19.1(0.75)
1/4	1/4	-TFT-FL4-NS4	29.7(1.17)	15.2(0.60)	14.3(0.56)	17.5(0.69)	4.8(0.19)	15.0(0.59)	22.4(0.88)
5/16	1/8	-TFT-FL5-NS2	29.7(1.17)	16.2(0.64)	15.9(0.63)	15.9(0.63)	6.4(0.25)	10.4(0.41)	19.1(0.75)
3/8	1/4	-TFT-FL6-NS4	31.2(1.23)	16.8(0.66)	17.5(0.69)	17.5(0.69)	7.1(0.28)	15.0(0.59)	22.4(0.88)
1/2	1/4	-TFT-FL8-NS4	36.1(1.42)	22.9(0.90)	22.2(0.87)	20.6(0.81)	10.4(0.41)	15.0(0.59)	22.4(0.88)
1/2	3/8	-TFT-FL8-NS6	36.1(1.42)	22.9(0.90)	22.2(0.87)	20.6(0.81)	10.4(0.41)	15.0(0.59)	22.4(0.88)
1/2	1/2	-TFT-FL8-NS8	39.9(1.57)	22.9(0.90)	22.2(0.87)	27.0(1.06)	10.4(0.41)	19.8(0.78)	28.4(1.12)
5/8	1/2	-TFT-FL10-NS8	39.9(1.57)	24.4(0.96)	25.4(1.00)	27.0(1.06)	12.7(0.50)	19.8(0.78)	28.4(1.12)
3/4	3/4	-TFT-FL12-NS12	44.7(1.76)	24.4(0.96)	28.6(1.13)	34.9(1.37)	15.7(0.62)	20.6(0.81)	31.8(1.25)
7/8	1/2	-TFT-FL14-NS8	44.7(1.76)	25.9(1.02)	31.8(1.25)	34.9(1.37)	15.7(0.62)	19.8(0.78)	28.4(1.12)
7/8	3/4	-TFT-FL14-NS12	44.7(1.76)	25.9(1.02)	31.8(1.25)	34.9(1.37)	18.3(0.72)	20.6(0.81)	31.8(1.25)
1	3/4	-TFT-FL16-NS12	49.0(1.93)	31.2(1.23)	38.1(1.50)	34.9(1.37)	22.4(0.88)	20.6(0.81)	31.8(1.25)
1	1	-TFT-FL16-NS16	53.6(2.11)	31.2(1.23)	38.1(1.50)	42.9(1.69)	22.4(0.88)	25.4(1.00)	38.1(1.50)

Метрическая трубка			Резьба NPT						
D нар. трубки T (мм)	Размер P-NPT	Артикул	Размеры, мм (дюймы)						
			L	C	G	F	E	B	Lx
6	1/8	-TFT-ML6-NS2	27.0(1.06)	15.3(0.60)	14.0(0.55)	12.7(0.50)	4.8(0.19)	10.4(0.41)	19.0(0.75)
6	1/4	-TFT-ML6-NS4	29.8(1.17)	15.3(0.60)	14.0(0.55)	17.5(0.69)	4.8(0.19)	15.0(0.59)	22.4(0.88)
8	1/8	-TFT-ML8-NS2	29.9(1.18)	16.2(0.64)	16.0(0.63)	15.9(0.63)	6.4(0.25)	10.4(0.41)	19.0(0.75)
8	1/4	-TFT-ML8-NS4	30.6(1.20)	16.2(0.64)	16.0(0.63)	17.5(0.69)	6.4(0.25)	15.0(0.59)	22.4(0.88)
10	1/4	-TFT-ML10-NS4	33.5(1.32)	17.2(0.68)	19.0(0.75)	20.6(0.81)	7.9(0.31)	15.0(0.59)	22.4(0.88)
12	1/4	-TFT-ML12-NS4	36.0(1.42)	22.8(0.90)	22.0(0.87)	20.6(0.81)	9.5(0.37)	15.0(0.59)	22.4(0.88)
12	3/8	-TFT-ML12-NS6	36.0(1.42)	22.8(0.90)	22.0(0.87)	20.6(0.81)	9.5(0.37)	15.0(0.59)	23.1(0.91)
12	1/2	-TFT-ML12-NS8	38.8(1.53)	22.8(0.90)	22.0(0.87)	25.4(1.00)	9.5(0.37)	19.8(0.78)	28.5(1.12)
16	1/2	-TFT-ML16-NS8	39.8(1.57)	24.4(0.96)	25.0(0.98)	27.0(1.06)	12.7(0.50)	19.8(0.78)	28.4(1.12)

Тройник проходной

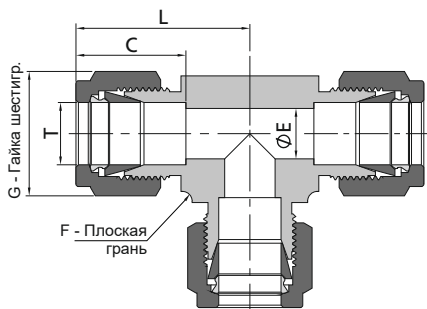

Дюймовая трубка						
D нар. трубки T (дюймы)	Артикул	Размеры, мм (дюймы)				
		L	C	G	F	E
1/16	-TTT-FL1	17.8(0.70)	8.6(0.34)	7.9(0.31)	9.5(0.37)	1.3(0.05)
1/8	-TTT-FL2	22.2(0.87)	12.7(0.50)	11.1(0.44)	9.5(0.37)	2.3(0.09)
3/16	-TTT-FL3	24.4(0.96)	13.7(0.54)	12.7(0.50)	11.1(0.44)	3.0(0.12)
1/4	-TTT-FL4	26.9(1.06)	15.2(0.60)	14.3(0.56)	12.7(0.50)	4.8(0.19)
5/16	-TTT-FL5	29.7(1.17)	16.2(0.64)	15.9(0.63)	15.9(0.63)	6.4(0.25)
3/8	-TTT-FL6	30.5(1.20)	16.8(0.66)	17.5(0.69)	15.9(0.63)	7.1(0.28)
1/2	-TTT-FL8	36.1(1.42)	22.9(0.90)	22.2(0.87)	20.6(0.81)	10.4(0.41)
5/8	-TTT-FL10	38.9(1.53)	24.4(0.96)	25.4(1.00)	25.4(1.00)	12.7(0.50)
3/4	-TTT-FL12	39.9(1.57)	24.4(0.96)	28.6(1.13)	27.0(1.06)	15.7(0.62)
7/8	-TTT-FL14	44.7(1.76)	25.9(1.02)	31.8(1.25)	34.9(1.37)	18.3(0.72)
1	-TTT-FL16	49.0(1.93)	31.2(1.23)	38.1(1.50)	34.9(1.37)	22.4(0.88)
1 1/8	-TTT-FL18	55.1(2.17)	36.7(1.44)	44.5(1.75)	42.9(1.69)	24.6(0.97)
1 1/4	-TTT-FL20	66.5(2.62)	41.1(1.62)	47.6(1.87)	42.9(1.69)	27.7(1.09)
1 1/2	-TTT-FL24	78.0(3.07)	50.0(1.97)	57.2(2.25)	50.8(2.00)	34.0(1.34)

Метрическая трубка						
D нар. трубки T (мм)	Артикул	Размеры, мм (дюймы)				
		L	C	G	F	E
2	-TTT-ML2	22.3(0.88)	12.9(0.51)	12.0(0.47)	9.5(0.37)	1.7(0.07)
3	-TTT-ML3	22.3(0.88)	12.9(0.51)	12.0(0.47)	9.5(0.37)	2.4(0.09)
4	-TTT-ML4	25.4(1.00)	13.7(0.54)	12.0(0.47)	12.7(0.50)	2.4(0.09)
6	-TTT-ML6	27.0(1.06)	15.3(0.60)	14.0(0.55)	12.7(0.50)	4.8(0.19)
8	-TTT-ML8	29.9(1.18)	16.2(0.64)	16.0(0.63)	15.9(0.63)	6.4(0.25)
10	-TTT-ML10	31.5(1.24)	17.2(0.68)	19.0(0.75)	17.5(0.69)	7.9(0.31)
12	-TTT-ML12	36.0(1.42)	22.8(0.90)	22.0(0.87)	20.6(0.81)	9.5(0.37)
14	-TTT-ML14	38.8(1.53)	24.4(0.96)	25.0(0.98)	25.4(1.00)	11.1(0.44)
15	-TTT-ML15	38.8(1.53)	24.4(0.96)	25.0(0.98)	25.4(1.00)	11.9(0.47)
16	-TTT-ML16	38.8(1.53)	24.4(0.96)	25.0(0.98)	25.4(1.00)	12.7(0.50)
18	-TTT-ML18	39.8(1.57)	24.4(0.96)	30.0(1.18)	27.0(1.06)	15.1(0.59)
20	-TTT-ML20	44.6(1.76)	26.0(1.02)	32.0(1.26)	34.9(1.37)	15.9(0.63)
22	-TTT-ML22	44.6(1.76)	26.0(1.02)	32.0(1.26)	34.9(1.37)	18.3(0.72)
25	-TTT-ML25	49.1(1.93)	31.3(1.23)	38.0(1.50)	34.9(1.37)	21.8(0.86)
28	-TTT-ML28	64.0(2.52)	36.6(1.44)	46.0(1.81)	42.9(1.69)	21.8(0.86)
30	-TTT-ML30	69.9(2.75)	39.6(1.56)	50.0(1.97)	42.9(1.69)	26.2(1.03)
32	-TTT-ML32	72.3(2.85)	42.0(1.65)	50.0(1.97)	42.9(1.69)	28.6(1.13)
38	-TTT-ML38	84.0(3.31)	49.4(1.94)	60.0(2.36)	50.8(2.00)	33.7(1.33)

Тройник переходной

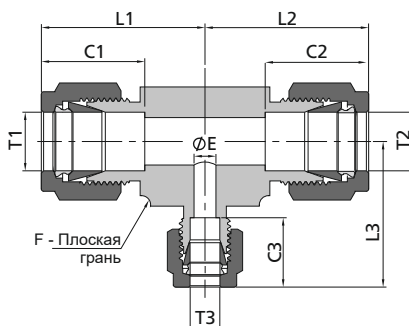

Метрическая трубка				Размеры, мм (дюймы)								
D нар. трубки T1 (мм)	D нар. трубки T2 (мм)	D нар. трубки T3 (мм)	Артикул	L1	L2	L3	C1	C2	C3	F	E	
3	3	6	-TTT-ML3-ML3-ML6	24.7(0.97)	24.7(0.97)	27.0(1.06)	12.9(0.51)	12.9(0.51)	15.3(0.60)	12.7(0.50)	2.4(0.09)	
6	6	3	-TTT-ML6-ML6-ML3	27.0(1.06)	27.0(1.06)	24.7(0.97)	15.3(0.60)	15.3(0.60)	12.9(0.51)	12.7(0.50)	2.4(0.09)	
6	6	8	-TTT-ML6-ML6-ML8	28.0(1.10)	28.0(1.10)	28.8(1.13)	15.3(0.60)	15.3(0.60)	16.2(0.64)	14.3(0.56)	4.8(0.19)	
8	8	6	-TTT-ML8-ML8-ML6	30.0(1.18)	30.0(1.18)	29.0(1.14)	16.2(0.64)	16.2(0.64)	15.3(0.60)	15.9(0.63)	4.8(0.19)	
8	8	12	-TTT-ML8-ML8-ML12	35.2(1.39)	35.2(1.39)	36.0(1.42)	16.2(0.64)	16.2(0.64)	22.8(0.90)	20.6(0.81)	6.4(0.25)	
10	10	6	-TTT-ML10-ML10-ML6	31.5(1.24)	31.5(1.24)	29.9(1.18)	17.2(0.68)	17.2(0.68)	15.3(0.60)	17.5(0.69)	4.8(0.19)	
10	10	8	-TTT-ML10-ML10-ML8	31.5(1.24)	31.5(1.24)	30.7(1.21)	17.2(0.68)	17.2(0.68)	16.2(0.64)	17.5(0.69)	6.4(0.25)	
12	12	6	-TTT-ML12-ML12-ML6	36.0(1.42)	36.0(1.42)	31.8(1.25)	22.8(0.90)	22.8(0.90)	15.3(0.60)	20.6(0.81)	4.8(0.19)	
12	12	8	-TTT-ML12-ML12-ML8	36.0(1.42)	36.0(1.42)	32.0(1.26)	22.8(0.90)	22.8(0.90)	16.2(0.64)	20.6(0.81)	6.4(0.25)	
12	12	14	-TTT-ML12-ML12-ML14	38.0(1.50)	38.0(1.50)	38.0(1.50)	22.8(0.90)	22.8(0.90)	24.4(0.96)	25.4(1.00)	9.5(0.37)	
12	12	18	-TTT-ML12-ML12-ML18	39.8(1.57)	39.8(1.57)	39.8(1.57)	22.8(0.90)	22.8(0.90)	24.4(0.96)	27.0(1.06)	9.5(0.37)	
14	14	8	-TTT-ML14-ML14-ML8	38.0(1.50)	38.0(1.50)	35.5(1.40)	24.4(0.96)	24.4(0.96)	16.2(0.64)	25.4(1.00)	6.4(0.25)	
14	14	10	-TTT-ML14-ML14-ML10	38.0(1.50)	38.0(1.50)	36.7(1.44)	24.4(0.96)	24.4(0.96)	17.2(0.68)	25.4(1.00)	7.9(0.31)	
15	15	12	-TTT-ML15-ML15-ML12	38.8(1.53)	38.8(1.53)	38.8(1.53)	24.4(0.96)	24.4(0.96)	22.8(0.90)	25.4(1.00)	9.5(0.37)	
16	8	16	-TTT-ML16-ML8-ML16	38.8(1.53)	35.5(1.40)	38.8(1.53)	24.4(0.96)	16.2(0.64)	24.4(0.96)	25.4(1.00)	6.4(0.25)	
16	16	12	-TTT-ML16-ML16-ML12	38.8(1.53)	38.8(1.53)	38.9(1.53)	24.4(0.96)	24.4(0.96)	22.8(0.90)	25.4(1.00)	9.5(0.37)	
18	18	8	-TTT-ML18-ML18-ML8	39.8(1.57)	39.8(1.57)	39.0(1.54)	24.4(0.96)	24.4(0.96)	16.2(0.64)	27.0(1.06)	6.4(0.25)	
18	18	10	-TTT-ML18-ML18-ML10	39.8(1.57)	39.8(1.57)	37.4(1.47)	24.4(0.96)	24.4(0.96)	17.2(0.68)	27.0(1.06)	7.9(0.31)	
18	18	12	-TTT-ML18-ML18-ML12	39.8(1.57)	39.8(1.57)	39.8(1.57)	24.4(0.96)	24.4(0.96)	22.8(0.90)	27.0(1.06)	9.5(0.37)	
18	18	14	-TTT-ML18-ML18-ML14	39.8(1.57)	39.8(1.57)	39.8(1.57)	24.4(0.96)	24.4(0.96)	24.4(0.96)	27.0(1.06)	11.1(0.44)	
20	20	14	-TTT-ML20-ML20-ML14	44.6(1.76)	44.6(1.76)	44.6(1.76)	26.0(1.02)	26.0(1.02)	24.4(0.96)	34.9(1.37)	11.1(0.44)	
22	22	12	-TTT-ML22-ML22-ML12	44.6(1.76)	44.6(1.76)	44.6(1.76)	26.0(1.02)	26.0(1.02)	22.8(0.90)	34.9(1.37)	9.5(0.37)	
25	25	12	-TTT-ML25-ML25-ML12	49.1(1.93)	49.1(1.93)	44.7(1.76)	31.3(1.23)	31.3(1.23)	22.8(0.90)	34.9(1.37)	9.5(0.37)	

Крестовина проходная

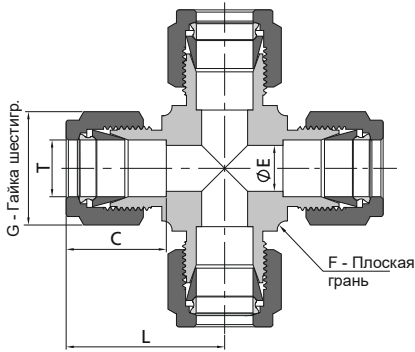

Дюймовая трубка						
D нар. трубки T (дюймы)	Артикул	Размеры, мм (дюймы)				
		L	C	G	F	E
1/8	-C-FL2	22.4(0.88)	12.7(0.50)	11.1(0.44)	9.5(0.37)	2.3(0.09)
3/16	-C-FL3	24.4(0.96)	13.7(0.54)	12.7(0.50)	11.1(0.44)	3.0(0.12)
1/4	-C-FL4	26.9(1.06)	15.2(0.60)	14.3(0.56)	12.7(0.50)	4.8(0.19)
5/16	-C-FL5	29.7(1.17)	16.2(0.64)	15.9(0.63)	15.9(0.63)	6.4(0.25)
3/8	-C-FL6	30.5(1.20)	16.8(0.66)	17.5(0.69)	15.9(0.63)	7.1(0.28)
1/2	-C-FL8	36.1(1.42)	22.9(0.90)	22.2(0.87)	20.6(0.81)	10.4(0.41)
5/8	-C-FL10	38.8(1.53)	24.4(0.96)	25.4(1.00)	25.4(1.0)	12.7(0.50)
3/4	-C-FL12	39.9(1.57)	24.4(0.96)	28.6(1.13)	27.0(1.06)	15.7(0.62)
7/8	-C-FL14	44.7(1.76)	25.9(1.02)	31.8(1.25)	34.9(1.37)	18.3(0.72)
1	-C-FL16	49.0(1.93)	31.2(1.23)	38.1(1.50)	34.9(1.37)	22.4(0.88)

Метрическая трубка						
D нар. трубки T (мм)	Артикул	Размеры, мм (дюймы)				
		L	C	G	F	E
3	-C-ML3	22.3(0.88)	12.9(0.51)	12.0(0.47)	9.5(0.37)	2.4(0.09)
4	-C-ML4	25.4(1.00)	13.7(0.54)	12.0(0.47)	12.7(0.50)	2.4(0.09)
6	-C-ML6	27.0(1.06)	15.3(0.60)	14.0(0.55)	12.7(0.50)	4.8(0.19)
8	-C-ML8	29.9(1.18)	16.2(0.64)	16.0(0.63)	15.9(0.63)	6.4(0.25)
10	-C-ML10	33.5(1.32)	17.2(0.68)	19.0(0.75)	20.6(0.81)	7.9(0.31)
12	-C-ML12	36.0(1.42)	22.8(0.90)	22.0(0.87)	20.6(0.81)	9.5(0.37)
16	-C-ML16	37.0(1.46)	24.4(0.96)	25.0(0.98)	23.8(0.94)	12.7(0.50)
18	-C-ML18	38.3(1.51)	24.4(0.96)	30.0(1.18)	27.0(1.06)	15.1(0.59)
20	-C-ML20	44.6(1.76)	26.0(1.02)	32.0(1.26)	34.9(1.37)	15.9(0.63)
22	-C-ML22	44.7(1.76)	26.0(1.02)	32.0(1.26)	34.9(1.37)	18.3(0.72)
25	-C-ML25	49.2(1.94)	31.3(1.23)	38.0(1.50)	34.9(1.37)	21.8(0.86)

Колпак

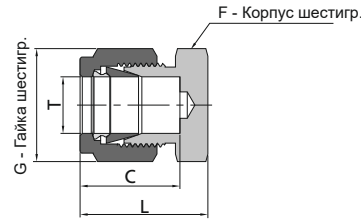

Дюймовая трубка					
D нар. трубки T (дюймы)	Артикул	Размеры, мм (дюймы)			
		L	C	G	F
1/16	-TC-FL1	15.0(0.59)	8.6(0.34)	7.9(0.31)	7.9(0.31)
1/8	-TC-FL2	20.1(0.79)	12.7(0.50)	11.1(0.44)	11.1(0.44)
3/16	-TC-FL3	21.3(0.84)	13.7(0.54)	12.7(0.50)	11.1(0.44)
1/4	-TC-FL4	23.4(0.92)	15.2(0.60)	14.3(0.56)	12.7(0.50)
5/16	-TC-FL5	24.4(0.96)	16.3(0.64)	15.9(0.63)	14.3(0.56)
3/8	-TC-FL6	25.7(1.01)	16.8(0.66)	17.5(0.69)	15.9(0.63)
1/2	-TC-FL8	29.2(1.15)	22.9(0.90)	22.2(0.87)	20.6(0.81)
5/8	-TC-FL10	30.0(1.18)	24.4(0.96)	25.4(1.00)	23.8(0.94)
3/4	-TC-FL12	31.5(1.24)	24.4(0.96)	28.6(1.13)	27.0(1.06)
7/8	-TC-FL14	34.0(1.34)	25.9(1.02)	31.8(1.25)	30.2(1.19)
1	-TC-FL16	38.4(1.51)	31.2(1.23)	38.1(1.50)	34.9(1.37)
1 1/8	-TC-FL18	38.4(1.51)	36.7(1.44)	44.5(1.75)	41.3(1.63)
1 1/4	-TC-FL20	53.3(2.10)	41.1(1.62)	47.6(1.87)	44.5(1.75)
1 1/2	-TC-FL24	64.5(2.54)	50.0(1.97)	57.2(2.25)	54.0(2.13)

Метрическая трубка					
D нар. трубки T (мм)	Артикул	Размеры, мм (дюймы)			
		L	C	G	F
2	-TC-ML2	20.1(0.79)	12.9(0.51)	12.0(0.47)	12.0(0.47)
3	-TC-ML3	20.1(0.79)	12.9(0.51)	12.0(0.47)	12.0(0.47)
4	-TC-ML4	21.3(0.84)	13.7(0.54)	12.0(0.47)	12.0(0.47)
6	-TC-ML6	23.1(0.91)	15.3(0.60)	14.0(0.55)	14.0(0.55)
8	-TC-ML8	24.5(0.96)	16.2(0.64)	16.0(0.63)	15.0(0.59)
10	-TC-ML10	26.6(1.05)	17.2(0.68)	19.0(0.75)	18.0(0.71)
12	-TC-ML12	29.1(1.15)	22.8(0.90)	22.0(0.87)	22.0(0.87)
14	-TC-ML14	29.9(1.18)	24.4(0.96)	25.0(0.98)	24.0(0.94)
15	-TC-ML15	29.9(1.18)	24.4(0.96)	25.0(0.98)	24.0(0.94)
16	-TC-ML16	29.9(1.18)	24.4(0.96)	25.0(0.98)	24.0(0.94)
18	-TC-ML18	31.4(1.24)	24.4(0.96)	30.0(1.18)	27.0(1.06)
20	-TC-ML20	34.0(1.34)	26.0(1.02)	32.0(1.26)	30.0(1.18)
22	-TC-ML22	34.0(1.34)	26.0(1.02)	32.0(1.26)	30.0(1.18)
25	-TC-ML25	38.5(1.52)	31.3(1.23)	38.0(1.50)	35.0(1.38)
28	-TC-ML28	48.5(1.91)	36.6(1.44)	46.0(1.81)	41.0(1.61)
30	-TC-ML30	53.4(2.10)	39.6(1.56)	50.0(1.97)	46.0(1.81)
32	-TC-ML32	55.8(2.20)	42.0(1.65)	50.0(1.97)	46.0(1.81)
38	-TC-ML38	65.4(2.57)	49.4(1.94)	60.0(2.36)	55.0(2.17)

Заглушка

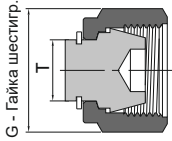

Дюймовая трубка		
D нар. трубки T (дюймы)	Артикул	Размеры, мм (дюймы)
		G
1/16	-TP-FL1	7.9(0.31)
1/8	-TP-FL2	11.1(0.44)
3/16	-TP-FL3	12.7(0.50)
1/4	-TP-FL4	14.3(0.56)
5/16	-TP-FL5	15.9(0.63)
3/8	-TP-FL6	17.5(0.69)
1/2	-TP-FL8	22.2(0.87)
5/8	-TP-FL10	25.4(1.00)
3/4	-TP-FL12	28.6(1.13)
7/8	-TP-FL14	31.8(1.25)
1	-TP-FL16	38.1(1.50)
1 1/4	-TP-FL20	47.6(1.87)
1 1/2	-TP-FL24	57.2(2.25)

Метрическая трубка		
D нар. трубки T (мм)	Артикул	Размеры, мм (дюймы)
		G
2	-TP-ML2	12.0(0.47)
3	-TP-ML3	12.0(0.47)
4	-TP-ML4	12.0(0.47)
6	-TP-ML6	14.0(0.55)
8	-TP-ML8	16.0(0.63)
10	-TP-ML10	19.0(0.75)
12	-TP-ML12	22.0(0.87)
14	-TP-ML14	25.0(0.98)
15	-TP-ML15	25.0(0.98)
16	-TP-ML16	25.0(0.98)
18	-TP-ML18	30.0(1.18)
20	-TP-ML20	32.0(1.26)
22	-TP-ML22	32.0(1.26)
25	-TP-ML25	38.0(1.50)
28	-TP-ML28	46.0(1.81)
30	-TP-ML30	50.0(1.97)
32	-TP-ML32	50.0(1.97)
38	-TP-ML38	60.0(2.36)

Защитная заглушка для вентиляционных отверстий

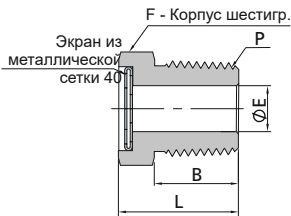

Экран из металлической сетки с ячейками 40 в сборе, нержавеющая сталь 300

Резьба NPT					
Размер P-NPT	Артикул	Размеры, мм (дюймы)			
		L	F	B	E
1/8	SS-VPF-NS2	14.2(0.56)	12.7(0.50)	9.7(0.38)	4.8(0.19)
1/4	SS-VPF-NS4	19.8(0.78)	14.3(0.56)	14.2(0.56)	7.1(0.28)
3/8	SS-VPF-NS6	20.6(0.81)	17.5(0.69)	14.2(0.56)	10.4(0.41)
1/2	SS-VPF-NS8	26.2(1.03)	22.2(0.87)	19.1(0.75)	12.7(0.50)
3/4	SS-VPF-NS12	26.9(1.06)	27.0(1.06)	19.2(0.76)	18.3(0.72)
1	SS-VPF-NS16	34.8(1.37)	34.9(1.37)	23.9(0.94)	22.4(0.88)

Для заказа из латуни замените нержавеющую сталь (SS) в артикуле на B
Пример: B-VPF-NS2

Соединитель для монтажа свободных фланцев (приварных внахлест)

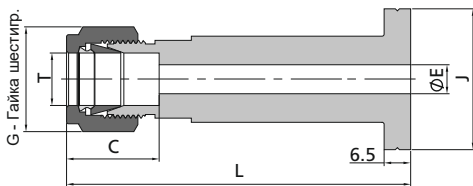

- Стандартный материал – 316 или Монель.
- Фланцевые торцы используются со свободно вращающимися фланцами NPS 1/2.
- Размеры фланцевых торцов устанавливаются в соответствии со спецификациями на фланцы "ANSI B16.5, класс 2500".
- Фланцевое уплотнение А предполагает обработку поверхности до шероховатости Ra 3,2-6,3 мкм, а фланцевое уплотнение В – до шероховатости Ra 6,3-12,5 мкм.

Дюймовая трубка							
D нар. трубки T (дюймы)	Фланц. уплот.	Артикул	Размеры, мм (дюймы)				
			L	G	C	E	J
1/4	A	-LFC-FL4A	80.8(3.18)	14.3(0.56)	15.2(0.60)	4.8(0.19)	34.5(1.36)
1/4	B	-LFC-FL4B	80.8(3.18)	14.3(0.56)	15.2(0.60)	4.8(0.19)	34.5(1.36)
3/8	A	-LFC-FL6A	82.3(3.24)	17.5(0.69)	16.8(0.66)	7.1(0.28)	34.5(1.36)
3/8	B	-LFC-FL6B	82.3(3.24)	17.5(0.69)	16.8(0.66)	7.1(0.28)	34.5(1.36)
1/2	A	-LFC-FL8A	85.1(3.35)	22.2(0.87)	22.9(0.90)	7.9(0.31)	34.5(1.36)
1/2	B	-LFC-FL8B	85.1(3.35)	22.2(0.87)	22.9(0.90)	7.9(0.31)	34.5(1.36)

Метрическая трубка							
D нар. трубки T (мм)	Фланц. уплот.	Артикул	Размеры, мм (дюймы)				
			L	G	C	E	J
10	A	-LFC-ML10A	82.6(3.25)	19.0(0.75)	17.2(0.68)	7.9(0.31)	34.5(1.36)
10	B	-LFC-ML10B	82.6(3.25)	19.0(0.75)	17.2(0.68)	7.9(0.31)	34.5(1.36)

Гайка

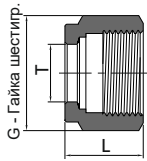

Дюймовая трубка		Размеры, мм (дюймы)	
D нар. трубки T (дюймы)	Артикул	L	G
		1/16	-N-FL1
1/8	-N-FL2	11.9(0.47)	11.1(0.44)
3/16	-N-FL3	11.9(0.47)	12.7(0.50)
1/4	-N-FL4	12.7(0.50)	14.3(0.56)
5/16	-N-FL5	13.5(0.53)	15.9(0.63)
3/8	-N-FL6	14.2(0.56)	17.5(0.69)
1/2	-N-FL8	17.5(0.69)	22.2(0.87)
5/8	-N-FL10	17.5(0.69)	25.4(1.00)
3/4	-N-FL12	17.5(0.69)	28.6(1.13)
7/8	-N-FL14	17.5(0.69)	31.8(1.25)
1	-N-FL16	20.6(0.81)	38.1(1.50)
1 1/8	-N-FL18	30.8(1.21)	44.5(1.75)
1 1/4	-N-FL20	31.8(1.25)	47.6(1.87)
1 1/2	-N-FL24	38.1(1.50)	57.2(2.25)

Метрическая трубка		Размеры, мм (дюймы)	
D нар. трубки T (мм)	Артикул	L	G
		2	-N-ML2
3	-N-ML3	11.9(0.47)	12.0(0.47)
4	-N-ML4	11.9(0.47)	12.0(0.47)
6	-N-ML6	12.7(0.50)	14.0(0.55)
8	-N-ML8	13.5(0.53)	16.0(0.63)
10	-N-ML10	15.1(0.59)	19.0(0.75)
12	-N-ML12	17.4(0.69)	22.0(0.87)
14	-N-ML14	17.4(0.69)	25.0(0.98)
15	-N-ML15	17.4(0.69)	25.0(0.98)
16	-N-ML16	17.4(0.69)	25.0(0.98)
18	-N-ML18	17.4(0.69)	30.0(1.18)
20	-N-ML20	17.4(0.69)	32.0(1.26)
22	-N-ML22	17.4(0.69)	32.0(1.26)
25	-N-ML25	20.6(0.81)	38.0(1.50)
28	-N-ML28	30.6(1.20)	46.0(1.81)
30	-N-ML30	32.7(1.29)	50.0(1.97)
32	-N-ML32	34.4(1.35)	50.0(1.97)
38	-N-ML38	40.6(1.60)	60.0(2.36)

Гайка с накаткой

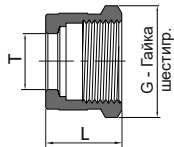

Для заказа гайки с накаткой добавьте К к артикулу гайки. Пример: **В-KN-FL4**

Гайка с наружной резьбой

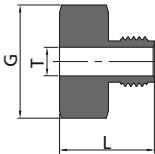

Дюймовая трубка		Размеры, мм (дюймы)	
D нар. трубки T (дюймы)	Артикул	L	G
		1/16	-MN-FL1
1/8	-MN-FL2	13.5(0.53)	9.5(0.37)
1/4	-MN-FL4	15.7(0.62)	12.7(0.50)
1/2	-MN-FL8	22.1(0.87)	23.8(0.94)

Метрическая трубка		Размеры, мм (дюймы)	
D нар. трубки T (мм)	Артикул	L	G
		3	-MN-ML3
6	-MN-ML6	15.7(0.62)	14.0(0.55)
10	-MN-ML10	22.1(0.87)	22.0(0.87)
12	-MN-ML12	22.1(0.87)	24.0(0.94)

Применяется для трубных фитингов с внутренней резьбой, например, для фитингов с колонками

Изображение соединения

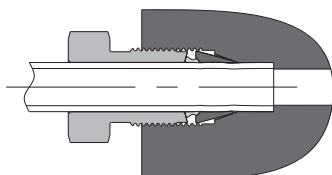

© Способ соединения

1. Пожалуйста, обратитесь к руководству по установке - Инструкции по монтажу, стр. А-12.
2. Не применяем с ручным или гидравлическим устройством для предварительного обжима.
3. Проверочный щуп не применим с данным типом соединения

Кольцо переднее обжимное

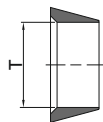

Кольцо заднее обжимное

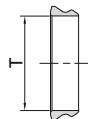

Дюймовая трубка

D нар. трубки T (дюймы)	Артикул
1/16	-FF-FL1
1/8	-FF-FL2
3/16	-FF-FL3
1/4	-FF-FL4
5/16	-FF-FL5
3/8	-FF-FL6
1/2	-FF-FL8
5/8	-FF-FL10
3/4	-FF-FL12
7/8	-FF-FL14
1	-FF-FL16
1 1/8	-FF-FL18*
1 1/4	-FF-FL20*
1 1/2	-FF-FL24*

Дюймовая трубка

D нар. трубки T (дюймы)	Артикул
1/16	-RF-FL1
1/8	-RF-FL2
3/16	-RF-FL3
1/4	-RF-FL4
5/16	-RF-FL5
3/8	-RF-FL6
1/2	-RF-FL8
5/8	-RF-FL10
3/4	-RF-FL12
7/8	-RF-FL14
1	-RF-FL16
1 1/8	-RF-FL18*
1 1/4	-RF-FL20*
1 1/2	-RF-FL24*

Метрическая трубка

D нар. трубки T (мм)	Артикул
2	-FF-ML2
3	-FF-ML3
4	-FF-ML4
6	-FF-ML6
8	-FF-ML8
10	-FF-ML10
12	-FF-ML12
14	-FF-ML14
15	-FF-ML15
16	-FF-ML16
18	-FF-ML18
20	-FF-ML20
22	-FF-ML22
25	-FF-ML25
28	-FF-ML28*
30	-FF-ML30*
32	-FF-ML32*
38	-FF-ML38*

Метрическая трубка

D нар. трубки T (мм)	Артикул
2	-RF-ML2
3	-RF-ML3
4	-RF-ML4
6	-RF-ML6
8	-RF-ML8
10	-RF-ML10
12	-RF-ML12
14	-RF-ML14
15	-RF-ML15
16	-RF-ML16
18	-RF-ML18
20	-RF-ML20
22	-RF-ML22
25	-RF-ML25
28	-RF-ML28*
30	-RF-ML30*
32	-RF-ML32*
38	-RF-ML38*

* Передние обжимные кольца из нержавеющей стали диаметром более 1 дюйма или 25 мм покрываются серебром

* Задние обжимные кольца из нержавеющей стали диаметром более 1 дюйма или 25 мм покрываются серебром

Комплект гайка, обжимные кольца



Каждый комплект гаек и обжимных колец содержит 1 гайку, 1 переднее обжимное кольцо и 1 заднее обжимное кольцо.

Дюймовая трубка	
D нар. трубки T (дюймы)	Артикул
1/16	-NFS-FL1
1/8	-NFS-FL2
3/16	-NFS-FL3
1/4	-NFS-FL4
5/16	-NFS-FL5
3/8	-NFS-FL6
1/2	-NFS-FL8
5/8	-NFS-FL10
3/4	-NFS-FL12

Метрическая трубка	
D нар. трубки T (мм)	Артикул
2	-NFS-ML2
3	-NFS-ML3
4	-NFS-ML4
6	-NFS-ML6
8	-NFS-ML8
10	-NFS-ML10
12	-NFS-ML12
14	-NFS-ML14
15	-NFS-ML15
16	-NFS-ML16
18	-NFS-ML18

Пожалуйста, заказывайте комплект гаек и обжимных колец, кратным 5. На картинке ниже показан набор гаек и обжимных колец. Один набор вмещает 5 комплектов гаек и обжимных колец.



Комплекты обжимных колец



Каждый комплект обжимных колец содержит 1 переднее обжимное кольцо и 1 заднее обжимное кольцо.

Дюймовая трубка	
D нар. трубки T (дюймы)	Артикул
1/16	-FRS-FL1
1/8	-FRS-FL2
3/16	-FRS-FL3
1/4	-FRS-FL4
5/16	-FRS-FL5
3/8	-FRS-FL6
1/2	-FRS-FL8
5/8	-FRS-FL10
3/4	-FRS-FL12

Метрическая трубка	
D нар. трубки T (мм)	Артикул
2	-FRS-ML2
3	-FRS-ML3
4	-FRS-ML4
6	-FRS-ML6
8	-FRS-ML8
10	-FRS-ML10
12	-FRS-ML12
14	-FRS-ML14
15	-FRS-ML15
16	-FRS-ML16
18	-FRS-ML18

Пожалуйста, заказывайте комплекты обжимных колец, кратным 10. На картинке ниже показаны комплекты обжимных колец в наборе. Один набор вмещает 10 комплектов обжимных колец.



Переходник

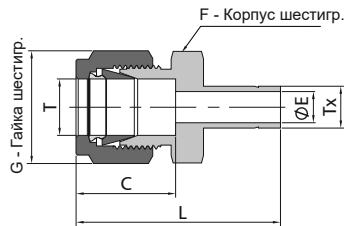

Дюймовая трубка

D нар. трубки Т (дюймы)	D нар. трубки Тх (дюймы)	Артикул	Размеры, мм (дюймы)				
			L	C	G	F	E
1/16	1/8	-R-FL1-FT2	29.2(1.15)	8.6(0.34)	7.9(0.31)	7.9(0.31)	1.3(0.05)
1/16	3/16	-R-FL1-FT3	30.0(1.18)	8.6(0.34)	7.9(0.31)	7.9(0.31)	1.3(0.05)
1/16	1/4	-R-FL1-FT4	31.5(1.24)	8.6(0.34)	7.9(0.31)	7.9(0.31)	1.3(0.05)
1/8	1/16	-R-FL2-FT1	29.0(1.14)	12.7(0.50)	11.1(0.44)	11.1(0.44)	0.8(0.03)
1/8	1/8	-R-FL2-FT2	33.5(1.32)	12.7(0.50)	11.1(0.44)	11.1(0.44)	2.0(0.08)
1/8	3/16	-R-FL2-FT3	34.3(1.35)	12.7(0.50)	11.1(0.44)	11.1(0.44)	2.3(0.09)
1/8	1/4	-R-FL2-FT4	36.1(1.42)	12.7(0.50)	11.1(0.44)	11.1(0.44)	2.3(0.09)
1/8	3/8	-R-FL2-FT6	37.6(1.48)	12.7(0.50)	11.1(0.44)	11.1(0.44)	2.3(0.09)
1/8	1/2	-R-FL2-FT8	44.2(1.74)	12.7(0.50)	11.1(0.44)	14.3(0.56)	2.3(0.09)
3/16	1/8	-R-FL3-FT2	34.8(1.37)	13.7(0.54)	12.7(0.50)	11.1(0.44)	2.0(0.08)
3/16	1/4	-R-FL3-FT4	37.1(1.46)	13.7(0.54)	12.7(0.50)	11.1(0.44)	3.0(0.12)
1/4	1/8	-R-FL4-FT2	36.8(1.45)	15.2(0.60)	14.3(0.56)	12.7(0.50)	2.0(0.08)
1/4	3/16	-R-FL4-FT3	37.6(1.48)	15.2(0.60)	14.3(0.56)	12.7(0.50)	3.0(0.12)
1/4	1/4	-R-FL4-FT4	39.1(1.54)	15.2(0.60)	14.3(0.56)	12.7(0.50)	4.3(0.17)
1/4	5/16	-R-FL4-FT5	39.9(1.57)	15.2(0.60)	14.3(0.56)	12.7(0.50)	4.8(0.19)
1/4	3/8	-R-FL4-FT6	40.6(1.60)	15.2(0.60)	14.3(0.56)	12.7(0.50)	4.8(0.19)
1/4	1/2	-R-FL4-FT8	46.2(1.82)	15.2(0.60)	14.3(0.56)	14.3(0.56)	4.8(0.19)
1/4	5/8	-R-FL4-FT10	48.0(1.89)	15.2(0.60)	14.3(0.56)	17.5(0.69)	4.8(0.19)
1/4	3/4	-R-FL4-FT12	47.8(1.88)	15.2(0.60)	14.3(0.56)	20.6(0.81)	4.8(0.19)
5/16	3/8	-R-FL5-FT6	41.9(1.65)	16.3(0.64)	15.9(0.63)	14.3(0.56)	6.4(0.25)
5/16	1/2	-R-FL5-FT8	47.5(1.87)	16.3(0.64)	15.9(0.63)	14.3(0.56)	6.4(0.25)
3/8	1/4	-R-FL6-FT4	41.4(1.63)	16.8(0.66)	17.5(0.69)	15.9(0.63)	4.3(0.17)
3/8	3/8	-R-FL6-FT6	43.2(1.70)	16.8(0.66)	17.5(0.69)	15.9(0.63)	6.9(0.27)
3/8	1/2	-R-FL6-FT8	48.5(1.91)	16.8(0.66)	17.5(0.69)	15.9(0.63)	7.1(0.28)
3/8	5/8	-R-FL6-FT10	50.3(1.98)	16.8(0.66)	17.5(0.69)	17.5(0.69)	7.1(0.28)
3/8	3/4	-R-FL6-FT12	50.3(1.98)	16.8(0.66)	17.5(0.69)	20.6(0.81)	7.1(0.28)
1/2	1/4	-R-FL8-FT4	45.0(1.77)	22.9(0.90)	22.2(0.87)	20.6(0.81)	4.3(0.17)
1/2	3/8	-R-FL8-FT6	46.7(1.84)	22.9(0.90)	22.2(0.87)	20.6(0.81)	6.9(0.27)
1/2	1/2	-R-FL8-FT8	52.3(2.06)	22.9(0.90)	22.2(0.87)	20.6(0.81)	9.4(0.37)
1/2	5/8	-R-FL8-FT10	53.8(2.12)	22.9(0.90)	22.2(0.87)	20.6(0.81)	10.4(0.41)
1/2	3/4	-R-FL8-FT12	53.8(2.12)	22.9(0.90)	22.2(0.87)	20.6(0.81)	10.4(0.41)
1/2	1	-R-FL8-FT16	60.2(2.37)	22.9(0.90)	22.2(0.87)	27.0(1.06)	10.4(0.41)
5/8	3/4	-R-FL10-FT12	54.6(2.15)	24.4(0.96)	25.4(1.00)	23.8(0.94)	12.7(0.50)
5/8	7/8	-R-FL10-FT14	56.1(2.21)	24.4(0.96)	25.4(1.00)	23.8(0.94)	12.7(0.50)
5/8	1	-R-FL10-FT16	61.0(2.40)	24.4(0.96)	25.4(1.00)	27.0(1.06)	12.7(0.50)
3/4	1/2	-R-FL12-FT8	54.6(2.15)	24.4(0.96)	28.6(1.13)	27.0(1.06)	9.4(0.37)
3/4	1	-R-FL12-FT16	62.5(2.46)	24.4(0.96)	28.6(1.13)	27.0(1.06)	15.7(0.62)
1	1 1/4	-R-FL16-AFT20	80.5(3.17)	31.2(1.23)	38.1(1.50)	34.9(1.37)	22.4(0.88)
1	1 1/2	-R-FL16-AFT24	89.2(3.51)	31.2(1.23)	38.1(1.50)	41.3(1.63)	22.4(0.88)
1	2	-R-FL16-AFT32	112.5(4.43)	31.2(1.23)	38.1(1.50)	54.0(2.13)	22.4(0.88)
1 1/4	1 1/2	-R-FL20-AFT24	104.1(4.10)	41.1(1.62)	47.6(1.87)	47.6(1.87)	27.7(1.09)

Переходник

Обжимные фитинги

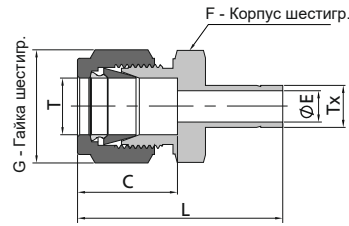

Метрическая трубка							
D нар. трубки T (мм)	D нар. трубки Tx (мм)	Артикул	Размеры, мм (дюймы)				
			L	C	G	F	E
2	3	-R-ML2-MT3	33.5(1.32)	12.9(0.51)	12.0(0.47)	12.0(0.47)	1.7(0.07)
3	4	-R-ML3-MT4	35.0(1.38)	12.9(0.51)	12.0(0.47)	12.0(0.47)	2.4(0.09)
3	6	-R-ML3-MT6	36.1(1.42)	12.9(0.51)	12.0(0.47)	12.0(0.47)	2.4(0.09)
3	10	-R-ML3-MT10	38.4(1.51)	12.9(0.51)	12.0(0.47)	14.0(0.55)	2.4(0.09)
4	6	-R-ML4-MT6	37.1(1.46)	13.7(0.54)	12.0(0.47)	12.0(0.47)	2.4(0.09)
6	3	-R-ML6-MT3	36.9(1.45)	15.3(0.60)	14.0(0.55)	14.0(0.55)	1.9(0.07)
6	8	-R-ML6-MT8	39.9(1.57)	15.3(0.60)	14.0(0.55)	14.0(0.55)	4.8(0.19)
6	10	-R-ML6-MT10	40.7(1.60)	15.3(0.60)	14.0(0.55)	14.0(0.55)	4.8(0.19)
6	12	-R-ML6-MT12	46.3(1.82)	15.3(0.60)	14.0(0.55)	14.0(0.55)	4.8(0.19)
6	18	-R-ML6-MT18	49.6(1.95)	15.3(0.60)	14.0(0.55)	22.0(0.87)	4.8(0.19)
8	6	-R-ML8-MT6	40.3(1.59)	16.2(0.64)	16.0(0.63)	15.0(0.59)	4.1(0.16)
8	10	-R-ML8-MT10	42.0(1.65)	16.2(0.64)	16.0(0.63)	15.0(0.59)	6.4(0.25)
8	12	-R-ML8-MT12	47.6(1.87)	16.2(0.64)	16.0(0.63)	15.0(0.59)	6.4(0.25)
10	6	-R-ML10-MT6	42.4(1.67)	17.2(0.68)	19.0(0.75)	18.0(0.71)	4.1(0.16)
10	8	-R-ML10-MT8	43.4(1.71)	17.2(0.68)	19.0(0.75)	18.0(0.71)	5.6(0.22)
10	12	-R-ML10-MT12	49.8(1.96)	17.2(0.68)	19.0(0.75)	18.0(0.71)	7.9(0.31)
10	15	-R-ML10-MT15	51.3(2.02)	17.2(0.68)	19.0(0.75)	18.0(0.71)	7.9(0.31)
10	18	-R-ML10-MT18	51.3(2.02)	17.2(0.68)	19.0(0.75)	22.0(0.87)	7.9(0.31)
12	6	-R-ML12-MT6	44.9(1.77)	22.8(0.90)	22.0(0.87)	22.0(0.87)	4.1(0.16)
12	8	-R-ML12-MT8	45.9(1.81)	22.8(0.90)	22.0(0.87)	22.0(0.87)	5.6(0.22)
12	10	-R-ML12-MT10	46.7(1.84)	22.8(0.90)	22.0(0.87)	22.0(0.87)	7.1(0.28)
12	16	-R-ML12-MT16	53.8(2.12)	22.8(0.90)	22.0(0.87)	22.0(0.87)	9.5(0.37)
12	18	-R-ML12-MT18	53.8(2.12)	22.8(0.90)	22.0(0.87)	22.0(0.87)	9.5(0.37)
12	20	-R-ML12-MT20	56.1(2.21)	22.8(0.90)	22.0(0.87)	22.0(0.87)	9.5(0.37)
12	22	-R-ML12-MT22	56.1(2.21)	22.8(0.90)	22.0(0.87)	24.0(0.94)	9.5(0.37)
12	25	-R-ML12-MT25	62.4(2.46)	22.8(0.90)	22.0(0.87)	27.0(1.06)	9.5(0.37)
16	12	-R-ML16-MT12	53.0(2.09)	24.4(0.96)	25.0(0.98)	24.0(0.94)	8.8(0.35)
18	12	-R-ML18-MT12	54.6(2.15)	24.4(0.96)	30.0(1.18)	27.0(1.06)	8.8(0.35)
18	16	-R-ML18-MT16	56.1(2.21)	24.4(0.96)	30.0(1.18)	27.0(1.06)	12.0(0.47)
18	20	-R-ML18-MT20	57.6(2.27)	24.4(0.96)	30.0(1.18)	27.0(1.06)	15.1(0.59)
18	22	-R-ML18-MT22	57.6(2.27)	24.4(0.96)	30.0(1.18)	27.0(1.06)	15.1(0.59)
18	25	-R-ML18-MT25	62.4(2.46)	24.4(0.96)	30.0(1.18)	27.0(1.06)	15.1(0.59)
20	16	-R-ML20-MT16	57.9(2.28)	26.0(1.02)	32.0(1.26)	30.0(1.18)	12.0(0.47)
20	18	-R-ML20-MT18	57.9(2.28)	26.0(1.02)	32.0(1.26)	30.0(1.18)	13.9(0.55)
20	22	-R-ML20-MT22	59.4(2.34)	26.0(1.02)	32.0(1.26)	30.0(1.18)	15.9(0.63)
20	25	-R-ML20-MT25	64.2(2.53)	26.0(1.02)	32.0(1.26)	30.0(1.18)	15.8(0.62)
22	18	-R-ML22-MT18	57.9(2.28)	26.0(1.02)	32.0(1.26)	30.0(1.18)	13.9(0.55)
22	20	-R-ML22-MT20	59.4(2.34)	26.0(1.02)	32.0(1.26)	30.0(1.18)	15.5(0.61)
22	25	-R-ML22-MT25	64.2(2.53)	26.0(1.02)	32.0(1.26)	30.0(1.18)	18.3(0.72)
25	18	-R-ML25-MT18	63.1(2.48)	31.3(1.23)	38.0(1.50)	35.0(1.38)	13.9(0.55)
25	20	-R-ML25-MT20	64.6(2.54)	31.3(1.23)	38.0(1.50)	35.0(1.38)	15.5(0.61)

Переходник

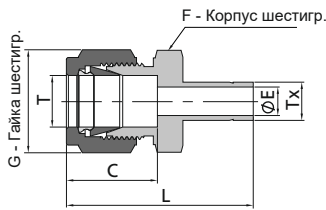

Метрическая трубка			Дюймовая трубка				
D нар. трубки T (мм)	D нар. трубки Tx (дюймы)	Артикул	Размеры, мм (дюймы)				
			L	C	G	F	E
2	1/8	-R-ML2-FT2	33.5(1.32)	12.9(0.51)	12.0(0.47)	12.0(0.47)	1.7(0.07)
3	1/8	-R-ML3-FT2	33.5(1.32)	12.9(0.51)	12.0(0.47)	12.0(0.47)	2.0(0.08)
3	1/4	-R-ML3-FT4	36.1(1.42)	12.9(0.51)	12.0(0.47)	12.0(0.47)	2.4(0.09)
4	1/4	-R-ML4-FT4	37.1(1.46)	13.7(0.54)	12.0(0.47)	12.0(0.47)	2.4(0.09)
6	1/8	-R-ML6-FT2	36.9(1.45)	15.3(0.60)	14.0(0.55)	14.0(0.55)	2.0(0.08)
6	1/4	-R-ML6-FT4	39.2(1.54)	15.3(0.60)	14.0(0.55)	14.0(0.55)	4.4(0.17)
6	5/16	-R-ML6-FT5	39.9(1.57)	15.3(0.60)	14.0(0.55)	14.0(0.55)	4.8(0.19)
6	3/8	-R-ML6-FT6	40.7(1.60)	15.3(0.60)	14.0(0.55)	14.0(0.55)	4.8(0.19)
6	1/2	-R-ML6-FT8	46.3(1.82)	15.3(0.60)	14.0(0.55)	14.0(0.55)	4.8(0.19)
8	1/4	-R-ML8-FT4	40.3(1.59)	16.2(0.64)	16.0(0.63)	15.0(0.59)	4.4(0.17)
8	3/8	-R-ML8-FT6	42.0(1.65)	16.2(0.64)	16.0(0.63)	15.0(0.59)	6.4(0.25)
8	1/2	-R-ML8-FT8	47.6(1.87)	16.2(0.64)	16.0(0.63)	15.0(0.59)	6.4(0.25)
10	3/8	-R-ML10-FT6	44.4(1.75)	17.2(0.68)	19.0(0.75)	18.0(0.71)	6.8(0.27)
10	1/2	-R-ML10-FT8	49.8(1.96)	17.2(0.68)	19.0(0.75)	18.0(0.71)	7.9(0.31)
12	1/2	-R-ML12-FT8	52.3(2.06)	22.8(0.90)	22.0(0.87)	22.0(0.87)	9.3(0.37)
12	3/4	-R-ML12-FT12	53.8(2.12)	22.8(0.90)	22.0(0.87)	22.0(0.87)	9.5(0.37)
18	3/4	-R-ML18-FT12	56.1(2.21)	24.4(0.96)	30.0(1.18)	27.0(1.06)	14.7(0.58)
18	1	-R-ML18-FT16	62.4(2.46)	24.4(0.96)	30.0(1.18)	27.0(1.06)	15.1(0.59)
25	1	-R-ML25-FT16	69.5(2.74)	31.3(1.23)	38.0(1.50)	35.0(1.38)	20.2(0.80)

Дюймовая трубка			Метрическая трубка				
D нар. трубки T (дюймы)	D нар. трубки Tx (мм)	Артикул	Размеры, мм (дюймы)				
			L	C	G	F	E
1/8	6	-R-FL2-MT6	36.1(1.42)	12.7(0.50)	11.1(0.44)	11.1(0.44)	2.3(0.09)

Переходник с монтажной гайкой

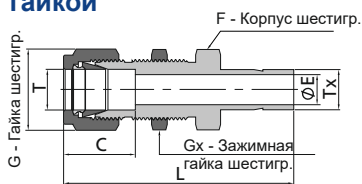

Дюймовая трубка			Размеры, мм (дюймы)					
D нар. трубки T (дюймы)	D нар. трубки Tx (дюймы)	Артикул	L	C	G	F	Gx	E
			1/8	1/8	-BR-FL2-FT2	49.5(1.95)	12.7(0.50)	11.1(0.44)
1/4	1/4	-BR-FL4-FT4	55.9(2.20)	15.2(0.60)	14.3(0.56)	15.9(0.63)	15.9(0.63)	4.3(0.17)
3/8	3/8	-BR-FL6-FT6	61.2(2.41)	16.8(0.66)	17.5(0.69)	19.1(0.75)	19.1(0.75)	6.9(0.27)
1/2	1/2	-BR-FL8-FT8	72.9(2.87)	22.9(0.90)	22.2(0.87)	23.8(0.94)	23.8(0.94)	9.4(0.37)
5/8	5/8	-BR-FL10-FT10	75.2(2.96)	24.4(0.96)	25.4(1.00)	27.0(1.06)	27.0(1.06)	11.9(0.47)
3/4	3/4	-BR-FL12-FT12	81.5(3.21)	24.4(0.96)	28.6(1.13)	30.2(1.19)	30.2(1.19)	14.7(0.58)
1	1	-BR-FL16-FT16	100.3(3.95)	31.2(1.23)	38.1(1.50)	41.3(1.63)	41.3(1.63)	20.3(0.80)

Угольник с переходником 90°

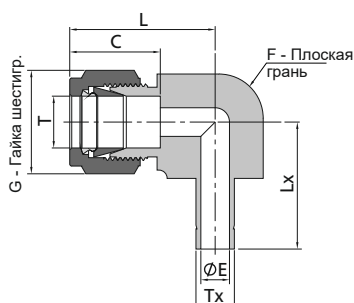

Метрическая трубка			Размеры, мм (дюймы)					
D нар. трубки T (мм)	D нар. трубки Tx (мм)	Артикул	L	C	G	F	E	Lx
			6	6	-LR-ML6-MT6	27.0(1.06)	15.3(0.60)	14.0(0.55)
12	12	-LR-ML12-MT12	38.1(1.50)	22.8(0.90)	22.0(0.87)	23.8(0.94)	8.8(0.35)	39.2(1.54)

Втулка для мягких пластиковых труб

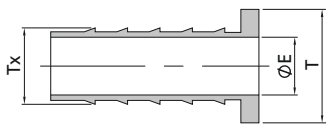

Дюймовая трубка

D нар. трубки T (дюймы)	D внутр. трубки Tx (дюймы)	Артикул	E мм (дюймы)
3/16	1/8	-IN-3-2	2.3(0.09)
1/4	1/8	-IN-4-2	2.3(0.09)
1/4	0.17	-IN-4-017	2.8(0.11)
1/4	3/16	-IN-4-3	3.5(0.14)
5/16	1/8	-IN-5-2	2.3(0.09)
5/16	3/16	-IN-5-3	3.0(0.12)
5/16	1/4	-IN-5-4	4.8(0.19)
3/8	3/16	-IN-6-3	3.0(0.12)
3/8	1/4	-IN-6-4	4.8(0.19)
1/2	1/4	-IN-8-4	4.8(0.19)
1/2	3/8	-IN-8-6	7.9(0.31)
5/8	3/8	-IN-10-6	7.9(0.31)
5/8	1/2	-IN-10-8	11.1(0.44)
3/4	1/2	-IN-12-8	11.1(0.44)
3/4	5/8	-IN-12-10	14.2(0.56)
1	3/4	-IN-16-12	17.5(0.69)

Метрическая трубка

D нар. трубки T (мм)	D внутр. трубки Tx (мм)	Артикул	E мм (дюймы)
6	4	-IN-6M-4M	2.8(0.11)
8	6	-IN-8M-6M	4.4(0.17)
10	8	-IN-10M-8M	6.4(0.25)
12	8	-IN-12M-8M	6.4(0.25)
12	10	-IN-12M-10M	8.3(0.33)

Информация для заказа

Добавьте обозначение материала перед артикулом, чтобы сформировать полный артикул.

Материал Обозначение материала

Нерж. сталь 316 SS

Латунь B

Сплав 400 (Монель) M

Пример: SS-IN-3-2

Соединитель для проходного канала

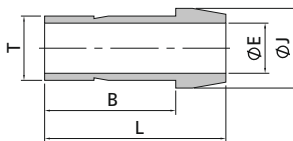

1" /25 мм и ниже

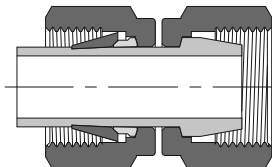

1 1/4" /28 мм и выше

Дюймовая трубка

D нар. трубки T (дюймы)	Артикул	Размеры, мм (дюймы)			
		L	B	E	J
1/16	-P-FL1	13.7(0.54)	10.7(0.42)	0.8(0.03)	3.3(0.13)
1/8	-P-FL2	22.4(0.88)	15.7(0.62)	2.0(0.08)	6.1(0.24)
1/4	-P-FL4	24.6(0.97)	18.8(0.74)	4.3(0.17)	9.4(0.37)
5/16	-P-FL5	25.9(1.02)	20.1(0.79)	5.6(0.22)	10.9(0.43)
3/8	-P-FL6	26.2(1.03)	20.3(0.80)	6.9(0.27)	12.7(0.50)
1/2	-P-FL8	35.8(1.41)	25.9(1.02)	9.4(0.37)	15.7(0.62)
5/8	-P-FL10	41.7(1.64)	28.1(1.11)	11.9(0.47)	20.5(0.81)
3/4	-P-FL12	41.9(1.65)	27.7(1.09)	14.7(0.58)	22.1(0.87)
1	-P-FL16	48.0(1.89)	34.5(1.36)	20.3(0.80)	28.4(1.12)
1 1/4	-P-FL20	69.1(2.72)	50.6(1.99)	25.9(1.02)	37.4(1.47)
1 1/2	-P-FL24	84.1(3.31)	59.4(2.34)	31.8(1.25)	45.8(1.80)

Метрическая трубка

D нар. трубки T (мм)	Артикул	Размеры, мм (дюймы)			
		L	B	E	J
3	-P-ML3	22.2(0.87)	15.7(0.62)	1.9(0.07)	6.0(0.24)
6	-P-ML6	24.6(0.97)	18.7(0.74)	4.1(0.16)	9.0(0.35)
8	-P-ML8	25.9(1.02)	20.0(0.79)	5.6(0.22)	11.0(0.43)
10	-P-ML10	26.1(1.03)	20.2(0.80)	7.1(0.28)	13.1(0.52)
12	-P-ML12	35.8(1.41)	26.0(1.02)	8.8(0.35)	15.0(0.59)
15	-P-ML15	37.8(1.49)	27.6(1.09)	11.2(0.44)	19.6(0.77)
16	-P-ML16	37.8(1.49)	27.6(1.09)	12.0(0.47)	20.6(0.81)
18	-P-ML18	37.8(1.49)	27.7(1.09)	13.9(0.55)	21.0(0.83)
20	-P-ML20	39.4(1.55)	29.2(1.15)	15.5(0.61)	24.6(0.97)
25	-P-ML25	49.3(1.94)	34.5(1.36)	19.9(0.78)	31.2(1.23)
28	-P-ML28	63.5(2.5)	48.3(1.90)	22.5(0.89)	34.4(1.35)
30	-P-ML30	67.6(2.66)	52.2(2.06)	24.3(0.96)	37.4(1.47)
32	-P-ML32	69.7(2.74)	52.4(2.06)	26.5(1.04)	39.4(1.55)
38	-P-ML38	81.9(3.22)	61.4(2.42)	31.6(1.24)	45.8(1.80)

Переходник для проходного канала

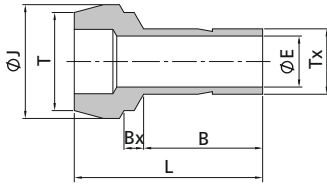

Дюймовая трубка

D нар. трубки T (дюймы)	D нар. трубки Tx (дюймы)	Артикул	Размеры, мм (дюймы)				
			L	B	E	Bx	J
1/8	1/16	-P-FL2-FL1	17.3(0.68)	8.6(0.34)	0.8(0.03)	2.0(0.08)	6.1(0.24)
1/4	1/16	-P-FL4-FL1	18.0(0.71)	8.6(0.34)	0.8(0.03)	3.6(0.14)	9.4(0.37)
1/4	1/8	-P-FL4-FL2	22.6(0.89)	13.5(0.53)	2.0(0.08)	3.3(0.13)	9.4(0.37)
3/8	1/8	-P-FL6-FL2	23.1(0.91)	13.5(0.53)	2.0(0.08)	3.8(0.15)	12.7(0.50)
3/8	1/4	-P-FL6-FL4	24.9(0.98)	15.7(0.62)	4.3(0.17)	3.3(0.13)	12.7(0.50)
1/2	1/4	-P-FL8-FL4	29.2(1.15)	15.7(0.62)	4.3(0.17)	3.8(0.15)	15.7(0.62)
1/2	3/8	-P-FL8-FL6	30.5(1.20)	17.5(0.69)	6.9(0.27)	3.3(0.13)	15.7(0.62)
3/4	1/2	-P-FL12-FL8	37.8(1.49)	23.1(0.91)	9.4(0.37)	3.8(0.15)	22.1(0.87)
1	1/2	-P-FL16-FL8	42.9(1.69)	24.4(0.96)	9.4(0.37)	4.8(0.19)	28.5(1.12)
1	3/4	-P-FL16-FL12	43.7(1.72)	25.9(1.02)	14.7(0.58)	4.1(0.16)	28.5(1.12)

Метрическая трубка

D нар. трубки T (мм)	D нар. трубки Tx (мм)	Артикул	Размеры, мм (дюймы)				
			L	B	E	Bx	J
6	3	-P-ML6-ML3	22.6(0.89)	13.5(0.53)	1.9(0.07)	3.2(0.13)	9.0(0.35)
8	6	-P-ML8-ML6	24.7(0.97)	15.7(0.62)	4.1(0.16)	3.1(0.12)	11.0(0.43)
10	6	-P-ML10-ML6	25.0(0.98)	15.7(0.62)	4.1(0.16)	3.4(0.13)	13.1(0.52)
10	8	-P-ML10-ML8	26.3(1.04)	17.0(0.67)	5.6(0.22)	3.1(0.12)	13.1(0.52)
12	6	-P-ML12-ML6	29.6(1.17)	15.7(0.62)	4.1(0.16)	3.6(0.14)	15.0(0.59)
12	8	-P-ML12-ML8	29.8(1.17)	16.8(0.66)	5.6(0.22)	3.4(0.13)	15.0(0.59)
12	10	-P-ML12-ML10	30.4(1.20)	17.5(0.69)	7.1(0.28)	3.1(0.12)	15.0(0.59)
16	12	-P-ML16-ML12	36.2(1.43)	23.1(0.91)	8.8(0.35)	3.4(0.13)	19.0(0.75)
28	25	-P-ML28-ML25	56.5(2.22)	33.0(1.30)	19.8(0.78)	8.2(0.32)	34.3(1.35)
32	25	-P-ML32-ML25	60.3(2.37)	33.0(1.30)	19.8(0.78)	9.9(0.39)	39.5(1.56)
38	25	-P-ML38-ML25	65.8(2.59)	33.0(1.30)	19.8(0.78)	12.3(0.48)	47.1(1.85)

Фитинг фланцевый санитарно-технический

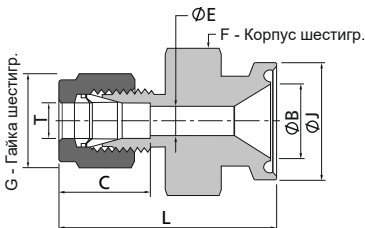

Дюймовая трубка

D нар. трубки T (дюймы)	Размер фланца (дюймы)	Артикул	Размеры, мм (дюймы)						
			L	B	C	E	F	J	G
1/4	1/2	-SFF-FL4-SC8	39.9(1.57)	9.4(0.37)	15.2(0.60)	4.8(0.19)	25.4(1.00)	24.9(0.98)	14.3(0.56)
1/4	3/4	-SFF-FL4-SC12	39.9(1.57)	15.7(0.62)	15.2(0.60)	4.8(0.19)	25.4(1.00)	24.9(0.98)	14.3(0.56)
1/4	1	-SFF-FL4-SC16	39.9(1.57)	22.1(0.87)	15.2(0.60)	4.8(0.19)	34.9(1.37)	50.3(1.98)	14.3(0.56)
1/4	1 1/2	-SFF-FL4-SC24	39.9(1.57)	34.8(1.37)	15.2(0.60)	4.8(0.19)	34.9(1.37)	50.3(1.98)	14.3(0.56)
3/8	1/2	-SFF-FL6-SC8	41.4(1.63)	9.4(0.37)	16.8(0.66)	7.1(0.28)	25.4(1.00)	24.9(0.98)	17.5(0.69)
3/8	3/4	-SFF-FL6-SC12	41.4(1.63)	15.7(0.62)	16.8(0.66)	7.1(0.28)	25.4(1.00)	24.9(0.98)	17.5(0.69)
3/8	1	-SFF-FL6-SC16	41.4(1.63)	22.1(0.87)	16.8(0.66)	7.1(0.28)	34.9(1.37)	50.3(1.98)	17.5(0.69)
3/8	1 1/2	-SFF-FL6-SC24	41.4(1.63)	34.8(1.37)	16.8(0.66)	7.1(0.28)	34.9(1.37)	50.3(1.98)	17.5(0.69)
1/2	1/2	-SFF-FL8-SC8	44.2(1.74)	9.4(0.37)	22.9(0.90)	9.4(0.37)	25.4(1.00)	24.9(0.98)	22.2(0.87)
1/2	3/4	-SFF-FL8-SC12	44.2(1.74)	15.7(0.62)	22.9(0.90)	10.4(0.41)	25.4(1.00)	24.9(0.98)	22.2(0.87)
1/2	1	-SFF-FL8-SC16	44.2(1.74)	22.1(0.87)	22.9(0.90)	10.4(0.41)	34.9(1.37)	50.3(1.98)	22.2(0.87)
1/2	1 1/2	-SFF-FL8-SC24	44.2(1.74)	34.8(1.37)	22.9(0.90)	10.4(0.41)	34.9(1.37)	50.3(1.98)	22.2(0.87)
1	1	-SFF-FL16-SC16	48.5(1.91)	22.1(0.87)	31.2(1.23)	22.1(0.87)	34.9(1.37)	50.3(1.98)	38.1(1.50)
1	2	-SFF-FL16-SC32	63.2(2.49)	34.8(1.37)	31.2(1.23)	22.4(0.88)	69.9(2.75)	64.0(2.52)	38.1(1.50)

Переходник с наружной резьбой

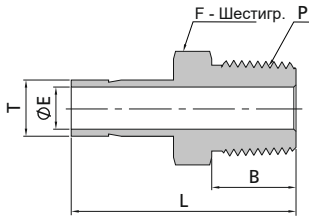

1" и ниже

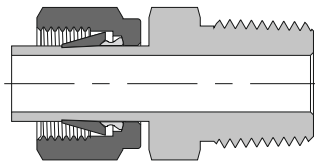

1 1/4" и выше

Обжимные фитинги

Дюймовая трубка			Резьба NPT			
D нар. трубки T (дюймы)	Размер P-NPT	Артикул	Размеры, мм (дюймы)			
			L	B	E	F
1/16	1/8	-AM-FT1-NS2	25.4(1.00)	9.7(0.38)	0.8(0.03)	11.1(0.44)
1/8	1/8	-AM-FT2-NS2	29.5(1.16)	9.7(0.38)	2.0(0.08)	11.1(0.44)
1/8	1/4	-AM-FT2-NS4	34.8(1.37)	14.2(0.56)	2.0(0.08)	14.3(0.56)
3/16	1/8	-AM-FT3-NS2	30.2(1.19)	9.7(0.38)	3.0(0.12)	11.1(0.44)
3/16	1/4	-AM-FT3-NS4	35.6(1.40)	14.2(0.56)	3.0(0.12)	14.3(0.56)
1/4	1/8	-AM-FT4-NS2	31.8(1.25)	9.7(0.38)	4.3(0.17)	11.1(0.44)
1/4	1/4	-AM-FT4-NS4	37.1(1.46)	14.2(0.56)	4.3(0.17)	14.3(0.56)
1/4	3/8	-AM-FT4-NS6	37.8(1.49)	14.2(0.56)	4.3(0.17)	17.5(0.69)
1/4	1/2	-AM-FT4-NS8	43.4(1.71)	19.1(0.75)	4.3(0.17)	22.2(0.87)
5/16	1/8	-AM-FT5-NS2	32.8(1.29)	9.7(0.38)	4.8(0.19)	11.1(0.44)
5/16	1/4	-AM-FT5-NS4	38.1(1.50)	14.2(0.56)	5.6(0.22)	14.3(0.56)
5/16	3/8	-AM-FT5-NS6	38.9(1.53)	14.2(0.56)	5.6(0.22)	17.5(0.69)
5/16	1/2	-AM-FT5-NS8	44.2(1.74)	19.1(0.75)	5.6(0.22)	22.2(0.87)
3/8	1/8	-AM-FT6-NS2	33.5(1.32)	9.7(0.38)	4.8(0.19)	11.1(0.44)
3/8	1/4	-AM-FT6-NS4	38.9(1.53)	14.2(0.56)	6.9(0.27)	14.3(0.56)
3/8	3/8	-AM-FT6-NS6	39.6(1.56)	14.2(0.56)	6.9(0.27)	17.5(0.69)
3/8	1/2	-AM-FT6-NS8	45.2(1.78)	19.1(0.75)	6.9(0.27)	22.2(0.87)
1/2	1/4	-AM-FT8-NS4	44.5(1.75)	14.2(0.56)	7.1(0.28)	14.3(0.56)
1/2	3/8	-AM-FT8-NS6	45.2(1.78)	14.2(0.56)	9.4(0.37)	17.5(0.69)
1/2	1/2	-AM-FT8-NS8	50.8(2.00)	19.1(0.75)	9.4(0.37)	22.2(0.87)
5/8	1/2	-AM-FT10-NS8	52.3(2.06)	19.1(0.75)	11.9(0.47)	22.2(0.87)
3/4	1/2	-AM-FT12-NS8	52.3(2.06)	19.1(0.75)	11.9(0.47)	22.2(0.87)
3/4	3/4	-AM-FT12-NS12	52.3(2.06)	19.1(0.75)	14.7(0.58)	27.0(1.06)
3/4	1	-AM-FT12-NS16	61.2(2.41)	23.9(0.94)	14.7(0.58)	34.9(1.37)
1	3/4	-AM-FT16-NS12	58.7(2.31)	19.1(0.75)	15.7(0.62)	27.0(1.06)
1	1	-AM-FT16-NS16	66.0(2.60)	23.9(0.94)	20.3(0.80)	34.9(1.37)
1 1/4	1 1/4	-AM-AFT20-NS20	80.3(3.16)	23.9(0.94)	25.9(1.02)	44.5(1.75)
1 1/2	1 1/2	-AM-AFT24-NS24	94.5(3.72)	26.2(1.03)	31.8(1.25)	54.0(2.13)

Дюймовая трубка			Коническая резьба ISO (RT)			
D нар. трубки T (дюймы)	Размер P-RT	Артикул	Размеры, мм (дюймы)			
			L	B	E	F
1/8	1/8	-AM-FT2-RT2	29.5(1.16)	9.7(0.38)	2.0(0.08)	11.1(0.44)
1/8	1/4	-AM-FT2-RT4	34.8(1.37)	14.2(0.56)	2.0(0.08)	14.3(0.56)
1/4	1/8	-AM-FT4-RT2	31.8(1.25)	9.7(0.38)	4.3(0.17)	11.1(0.44)
1/4	1/4	-AM-FT4-RT4	37.1(1.46)	14.2(0.56)	4.3(0.17)	14.3(0.56)
1/4	3/8	-AM-FT4-RT6	37.8(1.49)	14.2(0.56)	4.3(0.17)	17.5(0.69)
1/4	1/2	-AM-FT4-RT8	43.4(1.71)	19.1(0.75)	4.3(0.17)	22.2(0.87)
5/16	1/8	-AM-FT5-RT2	32.8(1.29)	9.7(0.38)	4.8(0.19)	11.1(0.44)
5/16	1/4	-AM-FT5-RT4	38.1(1.50)	14.2(0.56)	5.6(0.22)	14.3(0.56)
3/8	1/4	-AM-FT6-RT4	38.9(1.53)	14.2(0.56)	6.9(0.27)	14.3(0.56)
3/8	3/8	-AM-FT6-RT6	39.6(1.56)	14.2(0.56)	6.9(0.27)	17.5(0.69)
3/8	1/2	-AM-FT6-RT8	45.2(1.78)	19.1(0.75)	6.9(0.27)	22.2(0.87)
1/2	1/4	-AM-FT8-RT4	44.5(1.75)	14.2(0.56)	7.1(0.28)	14.3(0.56)
1/2	3/8	-AM-FT8-RT6	45.2(1.78)	14.2(0.56)	9.4(0.37)	17.5(0.69)
1/2	1/2	-AM-FT8-RT8	50.8(2.00)	19.1(0.75)	9.4(0.37)	22.2(0.87)
5/8	3/8	-AM-FT10-RT6	48.5(1.91)	14.2(0.56)	9.5(0.37)	17.5(0.69)
5/8	1/2	-AM-FT10-RT8	52.3(2.06)	19.1(0.75)	11.9(0.47)	22.2(0.87)
3/4	3/4	-AM-FT12-RT12	52.3(2.06)	19.1(0.75)	14.7(0.58)	27.0(1.06)
1	1	-AM-FT16-RT16	66.0(2.60)	23.9(0.94)	20.3(0.80)	34.9(1.37)

Переходник с наружной резьбой

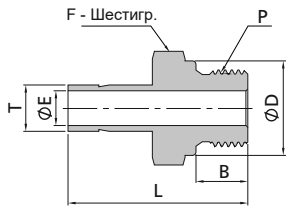

Дюймовая трубка			Цилиндрическая резьба ISO (RS)				
D нар. трубки T (дюймы)	Размер P-RS	Артикул	Размеры, мм (дюймы)				
			L	B	E	F	D
1/8	1/8	-AM-FT2-RS2	31.0(1.22)	7.1(0.28)	2.0(0.08)	14.3(0.56)	13.7(0.54)
1/8	1/4	-AM-FT2-RS4	35.8(1.41)	11.2(0.44)	2.0(0.08)	19.1(0.75)	17.8(0.70)
1/4	1/8	-AM-FT4-RS2	33.3(1.31)	7.1(0.28)	4.1(0.16)	14.3(0.56)	13.7(0.54)
1/4	1/4	-AM-FT4-RS4	38.1(1.50)	11.2(0.44)	4.3(0.17)	19.1(0.75)	17.8(0.70)
3/8	1/8	-AM-FT6-RS2	32.8(1.29)	7.1(0.28)	4.1(0.16)	14.3(0.56)	13.7(0.54)
3/8	1/4	-AM-FT6-RS4	39.9(1.57)	11.2(0.44)	5.8(0.23)	19.1(0.75)	17.8(0.70)
3/8	3/8	-AM-FT6-RS6	40.6(1.60)	11.2(0.44)	6.9(0.27)	22.2(0.87)	21.6(0.85)
3/8	1/2	-AM-FT6-RS8	42.9(1.69)	14.2(0.56)	7.1(0.28)	27.0(1.06)	25.9(1.02)
1/2	1/4	-AM-FT8-RS4	45.5(1.79)	11.2(0.44)	5.8(0.23)	19.1(0.75)	17.8(0.70)
1/2	3/8	-AM-FT8-RS6	46.2(1.82)	11.2(0.44)	7.9(0.31)	22.2(0.87)	21.6(0.85)
1/2	1/2	-AM-FT8-RS8	49.2(1.94)	14.2(0.56)	9.4(0.37)	27.0(1.06)	25.9(1.02)
5/8	1/2	-AM-FT10-RS8	50.0(1.97)	14.2(0.56)	11.9(0.47)	27.0(1.06)	25.9(1.02)
3/4	3/4	-AM-FT12-RS12	54.9(2.16)	16.0(0.63)	14.7(0.58)	33.3(1.31)	32.0(1.26)
1	1	-AM-FT16-RS16	64.5(2.54)	18.3(0.72)	20.3(0.80)	41.3(1.63)	38.9(1.53)

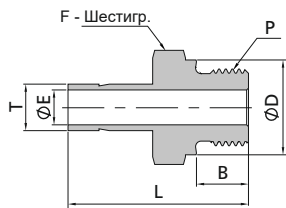

Дюймовая трубка			Цилиндрическая резьба ISO (RP)				
D нар. трубки T (дюймы)	Размер P-RP	Артикул	Размеры, мм (дюймы)				
			L	B	E	F	D
1/8	1/8	-AM-FT2-RP2	27.7(1.09)	7.1(0.28)	2.0(0.08)	14.3(0.56)	13.7(0.54)
1/8	1/4	-AM-FT2-RP4	33.3(1.31)	11.2(0.44)	2.0(0.08)	19.1(0.75)	17.8(0.70)
1/4	1/8	-AM-FT4-RP2	30.2(1.19)	7.1(0.28)	4.1(0.16)	14.3(0.56)	13.7(0.54)
1/4	1/4	-AM-FT4-RP4	38.1(1.50)	11.2(0.44)	4.6(0.18)	19.1(0.75)	17.8(0.70)
3/8	1/8	-AM-FT6-RP2	34.0(1.34)	7.1(0.28)	4.1(0.16)	19.1(0.75)	13.7(0.54)
3/8	1/4	-AM-FT6-RP4	37.3(1.47)	11.2(0.44)	6.4(0.25)	19.1(0.75)	17.8(0.70)
3/8	3/8	-AM-FT6-RP6	38.1(1.50)	11.2(0.44)	6.9(0.27)	22.2(0.87)	21.6(0.85)
3/8	1/2	-AM-FT6-RP8	42.9(1.69)	14.2(0.56)	6.9(0.27)	27.0(1.06)	25.9(1.02)
1/2	1/4	-AM-FT8-RP4	42.9(1.69)	11.2(0.44)	6.4(0.25)	19.1(0.75)	17.8(0.70)
1/2	3/8	-AM-FT8-RP6	43.7(1.72)	11.2(0.44)	7.9(0.31)	22.2(0.87)	21.6(0.85)
1/2	1/2	-AM-FT8-RP8	49.3(1.94)	14.2(0.56)	9.4(0.37)	27.0(1.06)	25.9(1.02)
5/8	1/2	-AM-FT10-RP8	50.0(1.97)	14.2(0.56)	11.9(0.47)	27.0(1.06)	25.9(1.02)
3/4	3/4	-AM-FT12-RP12	53.1(2.09)	16.0(0.63)	14.7(0.58)	33.5(1.32)	32.0(1.26)
1	1	-AM-FT16-RP16	63.3(2.49)	18.3(0.72)	19.8(0.78)	41.3(1.63)	38.9(1.53)

Переходник с наружной резьбой

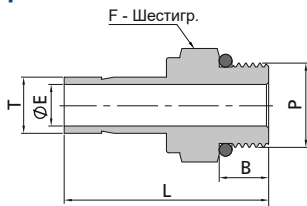

1" и ниже

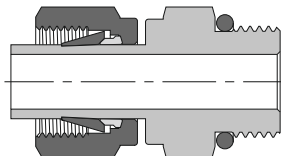

1 1/4" и выше

Переход к втулке с прямой резьбой SAE J1926-1, ISO 11926-1 и MS 16142.

Дюймовая трубка			Прямая резьба SAE/MS			
D нар. трубки T (дюймы)	Размер резьбы P-SAE/MS	Артикул	Размеры, мм (дюймы)			
			L	B	E	F
1/8	5/16-24	-AM-FT2-ST5	30.5(1.20)	7.6(0.30)	2.0(0.08)	11.1(0.44)
1/4	7/16-20	-AM-FT4-ST7	35.3(1.39)	9.1(0.36)	4.3(0.17)	14.3(0.56)
3/8	7/16-20	-AM-FT6-ST7	37.1(1.46)	9.1(0.36)	5.1(0.20)	14.3(0.56)
3/8	9/16-18	-AM-FT6-ST9	38.6(1.52)	9.9(0.39)	6.9(0.27)	17.5(0.69)
3/8	3/4-16	-AM-FT6-ST12	40.6(1.60)	11.2(0.44)	6.9(0.27)	22.2(0.87)
1/2	9/16-18	-AM-FT8-ST9	44.2(1.74)	9.9(0.39)	7.1(0.28)	17.5(0.69)
1/2	3/4-16	-AM-FT8-ST12	46.2(1.82)	11.2(0.44)	9.4(0.37)	22.2(0.87)
5/8	7/8-14	-AM-FT10-ST14	49.3(1.94)	12.7(0.50)	11.9(0.47)	25.4(1.00)
3/4	1 1/16-12	-AM-FT12-ST17	53.3(2.10)	15.0(0.59)	14.7(0.58)	31.8(1.25)
1	1 5/16-12	-AM-FT16-ST21	61.2(2.41)	15.0(0.59)	20.3(0.80)	38.1(1.50)
1 1/4	1 5/8-12	-AM-AFT20-ST26	71.4(2.81)	15.0(0.59)	25.9(1.02)	47.6(1.87)
1 1/2	1 7/8-12	-AM-AFT24-ST30	83.3(3.28)	15.0(0.59)	31.8(1.25)	54.0(2.13)

Дюймовая трубка			Развальцовка, конус 37° (AN)			
D нар. трубки T (дюймы)	Размер раструба трубки AN	Артикул	Размеры, мм (дюймы)			
			L	B	E	F
1/4	1/4	-AM-FT4-AN4	37.1(1.46)	14.0(0.55)	4.3(0.17)	12.7(0.50)
3/8	1/4	-AM-FT6-AN4	38.9(1.53)	14.0(0.55)	4.3(0.17)	12.7(0.50)
3/8	3/8	-AM-FT6-AN6	39.6(1.56)	14.2(0.56)	6.9(0.27)	15.9(0.63)
1/2	1/2	-AM-FT8-AN8	48.5(1.91)	16.8(0.66)	9.4(0.37)	20.6(0.81)
3/4	3/4	-AM-FT12-AN12	56.1(2.21)	21.8(0.86)	14.7(0.58)	28.6(1.13)
1	1	-AM-FT16-AN16	65.5(2.58)	23.1(0.91)	20.3(0.80)	34.9(1.37)

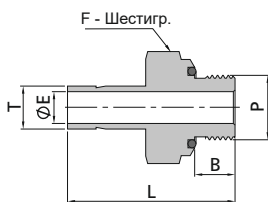
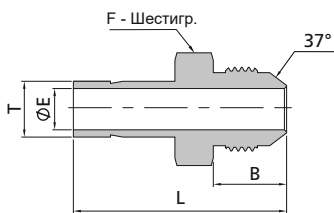

Дюймовая трубка			Кольцо уплотнительное с прямой резьбой SAE/MS			
D нар. трубки T (дюймы)	Размер резьбы P-SAE/MS	Артикул	Размеры, мм (дюймы)			
			L	B	E	F
1/8	5/16-24	-AM-FT2-OST5	32.5(1.28)	8.6(0.34)	2.0(0.08)	14.3(0.56)
3/16	3/8-24	-AM-FT3-OST6	35.1(1.38)	9.7(0.38)	3.0(0.12)	15.9(0.63)
1/4	7/16-20	-AM-FT4-OST7	39.1(1.54)	10.4(0.41)	4.3(0.17)	19.1(0.75)
5/16	1/2-20	-AM-FT5-OST8	41.7(1.64)	11.2(0.44)	5.6(0.22)	22.2(0.87)
3/8	9/16-18	-AM-FT6-OST9	43.2(1.70)	11.9(0.47)	6.9(0.27)	23.8(0.94)
1/2	3/4-16	-AM-FT8-OST12	49.5(1.95)	11.9(0.47)	9.4(0.37)	28.6(1.13)

Переходник с наружной резьбой

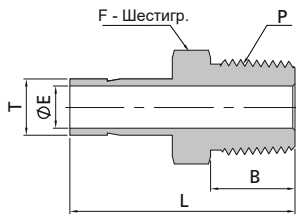

25 мм и ниже

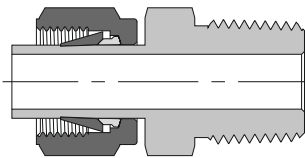

28 мм и выше

Метрическая трубка			Резьба NPT			
D нар. трубки T (мм)	Размер P-NPT	Артикул	Размеры, мм (дюймы)			
			L	B	E	F
3	1/8	-AM-MT3-NS2	29.4(1.16)	9.7(0.38)	1.8(0.07)	12.0(0.47)
4	1/8	-AM-MT4-NS2	29.4(1.16)	9.7(0.38)	2.4(0.09)	12.0(0.47)
6	1/8	-AM-MT6-NS2	32.8(1.29)	9.7(0.38)	4.1(0.16)	12.0(0.47)
6	1/4	-AM-MT6-NS4	38.1(1.50)	14.2(0.56)	4.1(0.16)	14.0(0.55)
6	3/8	-AM-MT6-NS6	39.2(1.54)	14.2(0.56)	4.1(0.16)	18.0(0.71)
6	1/2	-AM-MT6-NS8	42.1(1.66)	19.1(0.75)	4.1(0.16)	22.0(0.87)
8	1/4	-AM-MT8-NS4	39.1(1.54)	14.2(0.56)	5.6(0.22)	14.0(0.55)
8	3/8	-AM-MT8-NS6	39.9(1.57)	14.2(0.56)	5.6(0.22)	19.0(0.75)
10	1/4	-AM-MT10-NS4	39.9(1.57)	14.2(0.56)	7.1(0.28)	14.0(0.55)
10	3/8	-AM-MT10-NS6	40.6(1.60)	14.2(0.56)	7.1(0.28)	18.0(0.71)
10	1/2	-AM-MT10-NS8	46.2(1.82)	19.1(0.75)	7.1(0.28)	22.0(0.87)
12	1/4	-AM-MT12-NS4	46.5(1.83)	14.2(0.56)	7.1(0.28)	14.0(0.55)
12	3/8	-AM-MT12-NS6	46.2(1.82)	14.2(0.56)	8.8(0.35)	18.0(0.71)
12	1/2	-AM-MT12-NS8	52.1(2.05)	19.1(0.75)	8.8(0.35)	22.0(0.87)
16	1/2	-AM-MT16-NS8	50.8(2.00)	19.1(0.75)	11.9(0.47)	22.0(0.87)
16	3/4	-AM-MT16-NS12	51.6(2.03)	19.1(0.75)	12.0(0.47)	27.0(1.06)
18	1/2	-AM-MT18-NS8	50.8(2.00)	19.1(0.75)	11.9(0.47)	27.0(1.06)
18	3/4	-AM-MT18-NS12	51.6(2.03)	19.1(0.75)	14.0(0.55)	27.0(1.06)
20	1/2	-AM-MT20-NS8	53.3(2.1)	19.1(0.75)	11.9(0.47)	22.0(0.87)
20	3/4	-AM-MT20-NS12	53.8(2.12)	19.1(0.75)	15.5(0.61)	27.0(1.06)
25	1	-AM-MT25-NS16	65.9(2.59)	23.9(0.94)	19.8(0.78)	35.0(1.38)
28	1	-AM-AMT28-NS16	74.7(2.94)	23.9(0.94)	22.2(0.87)	35.0(1.38)
28	1 1/4	-AM-AMT28-NS20	76.2(3.00)	23.9(0.94)	22.5(0.89)	46.0(1.81)
30	1	-AM-AMT30-NS16	79.2(3.12)	23.9(0.94)	22.2(0.87)	41.0(1.61)
30	1 1/4	-AM-AMT30-NS20	80.0(3.15)	23.9(0.94)	24.3(0.96)	46.0(1.81)
32	1 1/4	-AM-AMT32-NS20	81.0(3.19)	23.9(0.94)	26.5(1.04)	46.0(1.81)
38	1 1/2	-AM-AMT38-NS24	92.2(3.63)	26.2(1.03)	31.6(1.24)	55.0(2.17)

Метрическая трубка			Коническая резьба ISO (RT)			
D нар. трубки T (мм)	Размер P-RT	Артикул	Размеры, мм (дюймы)			
			L	B	E	F
3	1/8	-AM-MT3-RT2	29.4(1.16)	9.7(0.38)	2.4(0.09)	12.0(0.47)
4	1/8	-AM-MT4-RT2	29.4(1.16)	9.7(0.38)	2.0(0.08)	12.0(0.47)
6	1/8	-AM-MT6-RT2	32.8(1.29)	9.7(0.38)	4.1(0.16)	12.0(0.47)
6	1/4	-AM-MT6-RT4	38.1(1.50)	14.2(0.56)	4.1(0.16)	14.0(0.55)
8	1/4	-AM-MT8-RT4	39.1(1.54)	14.2(0.56)	5.6(0.22)	14.0(0.55)
8	3/8	-AM-MT8-RT6	39.9(1.57)	14.2(0.56)	5.6(0.22)	18.0(0.71)
10	1/4	-AM-MT10-RT4	39.9(1.57)	14.2(0.56)	7.1(0.28)	14.0(0.55)
10	3/8	-AM-MT10-RT6	40.6(1.60)	14.2(0.56)	7.1(0.28)	18.0(0.71)
10	1/2	-AM-MT10-RT8	44.5(1.75)	19.1(0.75)	7.1(0.28)	22.0(0.87)
12	1/4	-AM-MT12-RT4	46.5(1.83)	14.2(0.56)	7.1(0.28)	16.0(0.63)
12	3/8	-AM-MT12-RT6	46.2(1.82)	14.2(0.56)	8.8(0.35)	18.0(0.71)
12	1/2	-AM-MT12-RT8	51.8(2.04)	19.1(0.75)	8.8(0.35)	22.0(0.87)
16	1/2	-AM-MT16-RT8	50.8(2.00)	19.1(0.75)	11.9(0.47)	22.0(0.87)
18	3/4	-AM-MT18-RT12	51.6(2.03)	19.1(0.75)	14.0(0.55)	27.0(1.06)
20	3/4	-AM-MT20-RT12	52.4(2.06)	19.1(0.75)	15.5(0.61)	27.0(1.06)
25	1	-AM-MT25-RT16	65.9(2.59)	23.9(0.94)	19.8(0.78)	35.0(1.38)
28	1	-AM-AMT28-RT16	74.7(2.94)	23.9(0.94)	22.2(0.87)	35.0(1.38)
28	1 1/4	-AM-AMT28-RT20	76.2(3.00)	23.9(0.94)	22.5(0.89)	46.0(1.81)
30	1 1/4	-AM-AMT30-RT20	80.0(3.15)	23.9(0.94)	24.3(0.96)	46.0(1.81)
32	1 1/4	-AM-AMT32-RT20	81.0(3.19)	23.9(0.94)	26.5(1.04)	46.0(1.81)
38	1 1/2	-AM-AMT38-RT24	92.2(3.63)	26.2(1.03)	31.6(1.24)	55.0(2.17)

Переходник с наружной резьбой

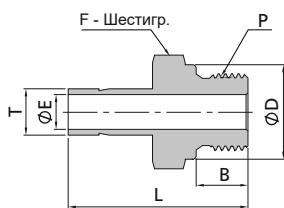

25 мм и ниже

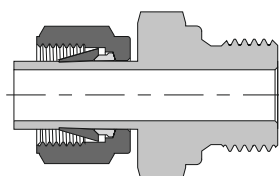

28 мм и выше

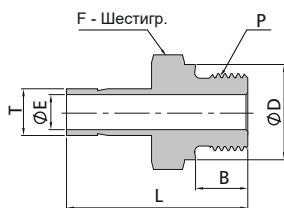

25 мм и ниже

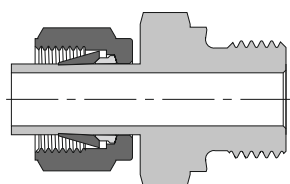

28 мм и выше

Метрическая трубка			Цилиндрическая резьба ISO (RS)				
D нар. трубки T (мм)	Размер P-RS	Артикул	Размеры, мм (дюймы)				
			L	B	E	F	D
3	1/8	-AM-MT3-RS2	31.0(1.22)	7.1(0.28)	1.8(0.07)	14.0(0.55)	13.7(0.54)
4	1/8	-AM-MT4-RS2	31.8(1.25)	7.1(0.28)	2.4(0.09)	14.0(0.55)	13.7(0.54)
6	1/8	-AM-MT6-RS2	34.3(1.35)	7.1(0.28)	4.0(0.16)	14.0(0.55)	13.7(0.54)
6	1/4	-AM-MT6-RS4	39.1(1.54)	11.2(0.44)	4.1(0.16)	19.0(0.75)	17.8(0.70)
8	1/4	-AM-MT8-RS4	39.1(1.54)	11.2(0.44)	5.6(0.22)	19.0(0.75)	17.8(0.70)
10	1/4	-AM-MT10-RS4	40.9(1.61)	11.2(0.44)	5.9(0.23)	19.0(0.75)	17.8(0.70)
10	3/8	-AM-MT10-RS6	41.7(1.64)	11.2(0.44)	7.1(0.28)	22.0(0.87)	21.6(0.85)
10	1/2	-AM-MT10-RS8	44.7(1.76)	14.2(0.56)	7.1(0.28)	27.0(1.06)	25.9(1.02)
12	1/4	-AM-MT12-RS4	46.7(1.84)	11.2(0.44)	5.9(0.23)	19.0(0.75)	17.8(0.70)
12	3/8	-AM-MT12-RS6	47.2(1.86)	11.2(0.44)	7.9(0.31)	22.0(0.87)	21.6(0.85)
12	1/2	-AM-MT12-RS8	50.5(1.99)	14.2(0.56)	8.8(0.35)	27.0(1.06)	25.9(1.02)
16	1/2	-AM-MT16-RS8	50.8(2.00)	14.2(0.56)	11.9(0.47)	27.0(1.06)	25.9(1.02)
18	3/4	-AM-MT18-RS12	55.9(2.20)	16.0(0.63)	13.9(0.55)	35.0(1.38)	32.0(1.26)
20	3/4	-AM-MT20-RS12	57.0(2.24)	16.0(0.63)	15.5(0.61)	35.0(1.38)	32.0(1.26)
25	1	-AM-MT25-RS16	65.1(2.56)	18.3(0.72)	19.8(0.78)	41.0(1.61)	38.9(1.53)
28	1	-AM-MT28-RS16	71.9(2.83)	18.3(0.72)	19.8(0.78)	41.0(1.61)	38.9(1.53)
28	1 1/4	-AM-MT28-RS20	77.0(3.03)	19.8(0.78)	22.5(0.89)	50.0(1.97)	49.0(1.93)
30	1 1/4	-AM-MT30-RS20	80.8(3.18)	19.8(0.78)	24.3(0.96)	50.0(1.97)	49.0(1.93)
32	1 1/4	-AM-MT32-RS20	81.8(3.22)	19.8(0.78)	26.5(1.04)	50.0(1.97)	49.0(1.93)
38	1 1/2	-AM-MT38-RS24	94.5(3.72)	20.6(0.81)	31.6(1.24)	55.0(2.17)	54.7(2.15)

Метрическая трубка			Цилиндрическая резьба ISO (RP)				
D нар. трубки T (мм)	Размер P-RP	Артикул	Размеры, мм (дюймы)				
			L	B	E	F	D
3	1/8	-AM-MT3-RP2	31.0(1.22)	7.1(0.28)	1.8(0.07)	14.0(0.55)	13.7(0.54)
4	1/8	-AM-MT4-RP2	31.8(1.25)	7.1(0.28)	2.0(0.08)	14.0(0.55)	13.7(0.54)
6	1/8	-AM-MT6-RP2	34.3(1.35)	7.1(0.28)	4.0(0.16)	14.0(0.55)	13.7(0.54)
6	1/4	-AM-MT6-RP4	38.1(1.50)	11.2(0.44)	4.0(0.16)	19.0(0.75)	17.8(0.70)
8	1/4	-AM-MT8-RP4	38.9(1.53)	11.2(0.44)	5.6(0.22)	19.0(0.75)	17.8(0.70)
10	1/4	-AM-MT10-RP4	38.9(1.53)	11.2(0.44)	6.4(0.25)	19.0(0.75)	17.8(0.70)
10	3/8	-AM-MT10-RP6	39.7(1.56)	11.2(0.44)	7.1(0.28)	22.0(0.87)	21.6(0.85)
10	1/2	-AM-MT10-RP8	42.9(1.69)	14.2(0.56)	7.1(0.28)	27.0(1.06)	25.9(1.02)
12	1/4	-AM-MT12-RP4	43.7(1.72)	11.2(0.44)	6.4(0.25)	19.0(0.75)	17.8(0.70)
12	3/8	-AM-MT12-RP6	44.5(1.75)	11.2(0.44)	7.9(0.31)	22.0(0.87)	21.6(0.85)
12	1/2	-AM-MT12-RP8	49.2(1.94)	14.2(0.56)	9.1(0.36)	27.0(1.06)	25.9(1.02)
16	1/2	-AM-MT16-RP8	50.8(2.00)	14.2(0.56)	11.9(0.47)	27.0(1.06)	25.9(1.02)
18	3/4	-AM-MT18-RP12	53.2(2.09)	16.0(0.63)	14.0(0.55)	33.0(1.30)	32.0(1.26)
20	3/4	-AM-MT20-RP12	54.0(2.13)	16.0(0.63)	15.5(0.61)	33.0(1.30)	32.0(1.26)
25	1	-AM-MT25-RP16	65.1(2.56)	18.3(0.72)	19.8(0.78)	41.0(1.61)	38.9(1.53)
28	1	-AM-MT28-RP16	72.7(2.86)	18.3(0.72)	19.8(0.78)	41.0(1.61)	38.9(1.53)
28	1 1/4	-AM-MT28-RP20	77.3(3.04)	19.8(0.78)	22.5(0.89)	50.0(1.97)	49.0(1.93)
30	1 1/4	-AM-MT30-RP20	80.8(3.18)	19.8(0.78)	24.3(0.96)	50.0(1.97)	49.0(1.93)
32	1 1/4	-AM-MT32-RP20	82.1(3.23)	19.8(0.78)	26.5(1.04)	50.0(1.97)	49.0(1.93)
38	1 1/2	-AM-MT38-RP24	94.5(3.72)	20.6(0.81)	31.6(1.24)	55.0(2.17)	54.7(2.15)

Переходник с внутренней резьбой

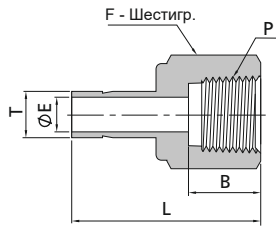

1" и ниже

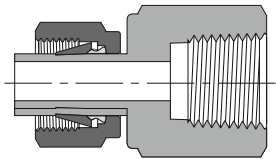

1 1/4" и выше

Дюймовая трубка			Резьба NPT			
D нар. трубки T (дюймы)	Размер P-NPT	Артикул	Размеры, мм (дюймы)			
			L	B	E	F
1/16	1/8	-AF-FT1-NS2	27.2(1.07)	10.4(0.41)	0.8(0.03)	14.3(0.56)
1/8	1/8	-AF-FT2-NS2	31.5(1.24)	10.4(0.41)	2.0(0.08)	14.3(0.56)
1/8	1/4	-AF-FT2-NS4	35.3(1.39)	15.0(0.59)	2.0(0.08)	19.1(0.75)
3/16	1/8	-AF-FT3-NS2	31.8(1.25)	10.4(0.41)	2.9(0.11)	14.3(0.56)
3/16	1/4	-AF-FT3-NS4	35.8(1.41)	15.0(0.59)	3.0(0.12)	19.1(0.75)
1/4	1/8	-AF-FT4-NS2	33.0(1.30)	10.4(0.41)	4.3(0.17)	14.3(0.56)
1/4	1/4	-AF-FT4-NS4	37.1(1.46)	15.0(0.59)	4.3(0.17)	19.1(0.75)
1/4	3/8	-AF-FT4-NS6	39.4(1.55)	15.0(0.59)	4.3(0.17)	22.2(0.87)
1/4	1/2	-AF-FT4-NS8	45.5(1.79)	19.8(0.78)	4.3(0.17)	27.0(1.06)
5/16	1/8	-AF-FT5-NS2	34.0(1.34)	10.4(0.41)	5.6(0.22)	14.3(0.56)
5/16	1/4	-AF-FT5-NS4	37.6(1.48)	15.0(0.59)	5.6(0.22)	19.1(0.75)
5/16	3/8	-AF-FT5-NS6	40.4(1.59)	15.0(0.59)	5.6(0.22)	22.2(0.87)
3/8	1/8	-AF-FT6-NS2	34.3(1.35)	10.4(0.41)	6.9(0.27)	14.3(0.56)
3/8	1/4	-AF-FT6-NS4	38.1(1.50)	15.0(0.59)	6.9(0.27)	19.1(0.75)
3/8	3/8	-AF-FT6-NS6	40.4(1.59)	15.0(0.59)	6.9(0.27)	22.2(0.87)
3/8	1/2	-AF-FT6-NS8	46.7(1.84)	19.8(0.78)	6.9(0.27)	27.0(1.06)
1/2	1/4	-AF-FT8-NS4	43.4(1.71)	15.0(0.59)	9.4(0.37)	19.1(0.75)
1/2	3/8	-AF-FT8-NS6	45.5(1.79)	15.0(0.59)	9.4(0.37)	22.2(0.87)
1/2	1/2	-AF-FT8-NS8	51.8(2.04)	19.8(0.78)	9.4(0.37)	27.0(1.06)
5/8	3/8	-AF-FT10-NS6	47.2(1.86)	15.0(0.59)	11.9(0.47)	22.2(0.87)
5/8	1/2	-AF-FT10-NS8	53.1(2.09)	19.8(0.78)	11.9(0.47)	27.0(1.06)
3/4	1/2	-AF-FT12-NS8	52.8(2.08)	19.8(0.78)	14.7(0.58)	27.0(1.06)
3/4	3/4	-AF-FT12-NS12	54.9(2.16)	20.6(0.81)	14.7(0.58)	33.3(1.31)
3/4	1	-AF-FT12-NS16	58.4(2.30)	25.4(1.00)	14.7(0.58)	41.3(1.63)
7/8	3/4	-AF-FT14-NS12	56.4(2.22)	20.6(0.81)	14.7(0.58)	33.3(1.31)
1	3/4	-AF-FT16-NS12	60.7(2.39)	20.6(0.81)	20.3(0.80)	33.3(1.31)
1	1	-AF-FT16-NS16	64.3(2.53)	25.4(1.00)	20.3(0.80)	41.3(1.63)
1 1/4	1 1/4	-AF-AFT20-NS20	77.7(3.06)	25.4(1.00)	25.9(1.02)	54.0(2.13)
1 1/2	1 1/2	-AF-AFT24-NS24	88.9(3.50)	27.7(1.09)	31.8(1.25)	60.3(2.37)

Дюймовая трубка			Коническая резьба ISO (RT)			
D нар. трубки T (дюймы)	Размер P-RT	Артикул	Размеры, мм (дюймы)			
			L	B	E	F
1/4	1/8	-AF-FT4-RT2	33.0(1.30)	10.4(0.41)	4.3(0.17)	14.3(0.56)
1/4	1/4	-AF-FT4-RT4	36.8(1.45)	15.0(0.59)	4.3(0.17)	19.1(0.75)
3/8	1/4	-AF-FT6-RT4	38.1(1.50)	15.0(0.59)	6.9(0.27)	19.1(0.75)
3/8	3/8	-AF-FT6-RT6	40.4(1.59)	15.0(0.59)	6.9(0.27)	22.2(0.87)
1/2	1/4	-AF-FT8-RT4	43.4(1.71)	15.0(0.59)	9.4(0.37)	19.1(0.75)
1/2	3/8	-AF-FT8-RT6	45.7(1.80)	15.0(0.59)	9.4(0.37)	22.2(0.87)
1/2	1/2	-AF-FT8-RT8	52.1(2.05)	19.8(0.78)	9.4(0.37)	27.0(1.06)

Переходник с внутренней резьбой

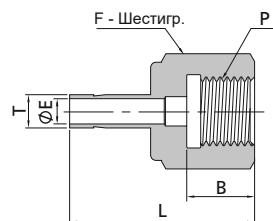
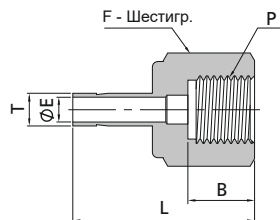
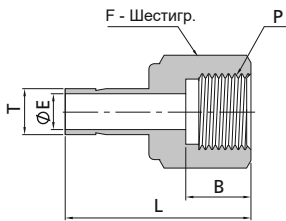

Переход к наружной резьбе в соответствии с японским стандартом для манометров

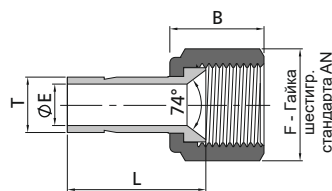

Дюймовая трубка			Цилиндрическая резьба ISO (RP)			
D нар. трубки T (дюймы)	Размер P-RP	Артикул	Размеры, мм (дюймы)			
			L	B	E	F
1/8	1/8	-AF-FT2-RP2	29.7(1.17)	10.2(0.40)	2.0(0.08)	14.3(0.56)
1/4	1/8	-AF-FT4-RP2	31.8(1.25)	10.2(0.40)	4.3(0.17)	14.3(0.56)
1/4	1/4	-AF-FT4-RP4	38.1(1.50)	15.5(0.61)	4.3(0.17)	19.1(0.75)
3/8	1/4	-AF-FT6-RP4	39.4(1.55)	15.5(0.61)	6.9(0.27)	19.1(0.75)
3/8	3/8	-AF-FT6-RP6	39.9(1.57)	15.2(0.60)	6.9(0.27)	23.8(0.94)
1/2	3/8	-AF-FT8-RP6	45.2(1.78)	15.2(0.60)	9.7(0.38)	23.8(0.94)
1/2	1/2	-AF-FT8-RP8	49.5(1.95)	18.5(0.73)	9.7(0.38)	27.0(1.06)

Дюймовая трубка			Цилиндрическая резьба ISO (RG)			
D нар. трубки T (дюймы)	Размер P-RG	Артикул	Размеры, мм (дюймы)			
			L	B	E	F
1/4	1/4	-AF-FT4-RG4	35.3(1.39)	12.9(0.51)	4.3(0.17)	19.1(0.75)
3/8	3/8	-AF-FT6-RG6	39.4(1.55)	14.2(0.56)	6.6(0.26)	23.8(0.94)
1/2	1/2	-AF-FT8-RG8	45.7(1.80)	18.8(0.74)	7.1(0.28)	27.0(1.06)

Дюймовая трубка			Цилиндрическая резьба ISO (RJ)			
D нар. трубки T (дюймы)	Размер P-RJ	Артикул	Размеры, мм (дюймы)			
			L	B	E	F
1/4	1/4	-AF-FT4-RJ4	35.3(1.39)	12.9(0.51)	4.3(0.17)	19.1(0.75)
3/8	3/8	-AF-FT6-RJ6	39.4(1.55)	15.8(0.62)	6.6(0.26)	23.8(0.94)
1/2	1/2	-AF-FT8-RJ8	49.3(1.94)	18.8(0.74)	7.1(0.28)	27.0(1.06)

Дюймовая трубка			Резьба AN			
D нар. трубки T (дюймы)	Размер раструба трубки AN (дюймы)	Артикул	Размеры, мм (дюймы)			
			L	B	E	F
1/8	1/8	-AF-FT2-AN2	22.4(0.88)	14.0(0.55)	2.0(0.08)	9.5(0.37)
1/8	1/4	-AF-FT2-AN4	22.4(0.88)	15.8(0.62)	4.0(0.16)	14.3(0.56)
1/4	1/4	-AF-FT4-AN4	24.4(0.96)	15.8(0.62)	4.6(0.18)	14.3(0.56)
3/8	3/8	-AF-FT6-AN6	24.9(0.98)	18.5(0.73)	6.8(0.27)	19.05(0.75)
1/2	1/2	-AF-FT8-AN8	36.1(1.42)	21.6(0.85)	9.4(0.37)	22.2(0.87)
3/4	3/4	-AF-FT12-AN12	37.8(1.49)	26.2(1.03)	14.7(0.58)	31.8(1.25)

Переходник с внутренней резьбой

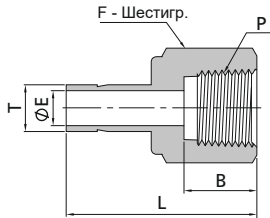

Метрическая трубка			Резьба NPT			
D нар. трубки T (мм)	Размер P-NPT	Артикул	Размеры, мм (дюймы)			
			L	B	E	F
3	1/8	-AF-MT3-NS2	28.8(1.13)	10.4(0.41)	1.3(0.05)	14.0(0.55)
4	1/8	-AF-MT4-NS2	33.3(1.31)	10.4(0.41)	2.4(0.09)	14.0(0.55)
6	1/8	-AF-MT6-NS2	32.5(1.28)	10.4(0.41)	4.1(0.16)	14.0(0.55)
6	1/4	-AF-MT6-NS4	37.1(1.46)	15.0(0.59)	4.1(0.16)	19.0(0.75)
8	1/8	-AF-MT8-NS2	35.1(1.38)	10.4(0.41)	5.6(0.22)	14.0(0.55)
8	1/4	-AF-MT8-NS4	37.6(1.48)	15.0(0.59)	5.6(0.22)	19.0(0.75)
8	3/8	-AF-MT8-NS6	36.5(1.44)	15.0(0.59)	5.6(0.22)	22.0(0.87)
10	1/4	-AF-MT10-NS4	38.1(1.50)	15.0(0.59)	7.1(0.28)	19.0(0.75)
10	3/8	-AF-MT10-NS6	40.1(1.58)	15.0(0.59)	7.1(0.28)	22.0(0.87)
10	1/2	-AF-MT10-NS8	46.5(1.83)	19.8(0.78)	7.1(0.28)	27.0(1.06)
12	1/4	-AF-MT12-NS4	43.7(1.72)	15.0(0.59)	8.8(0.35)	19.0(0.75)
12	3/8	-AF-MT12-NS6	42.9(1.69)	15.0(0.59)	8.8(0.35)	22.0(0.87)
12	1/2	-AF-MT12-NS8	52.3(2.06)	19.8(0.78)	8.8(0.35)	27.0(1.06)
16	1/2	-AF-MT16-NS8	49.2(1.94)	19.8(0.78)	12.0(0.47)	27.0(1.06)
18	3/4	-AF-MT18-NS12	52.4(2.06)	20.6(0.81)	14.0(0.55)	32.0(1.26)
20	1/2	-AF-MT20-NS8	50.0(1.97)	19.8(0.78)	15.5(0.61)	27.0(1.06)
20	3/4	-AF-MT20-NS12	57.2(2.25)	20.6(0.81)	15.5(0.61)	35.0(1.38)
25	1	-AF-MT25-NS16	66.7(2.63)	25.4(1.00)	19.8(0.78)	41.0(1.61)

Метрическая трубка			Коническая резьба ISO (RT)			
D нар. трубки T (мм)	Размер P-RT	Артикул	Размеры, мм (дюймы)			
			L	B	E	F
3	1/8	-AF-MT3-RT2	28.8(1.13)	10.4(0.41)	1.8(0.07)	14.0(0.55)
4	1/8	-AF-MT4-RT2	28.6(1.13)	10.4(0.41)	2.4(0.09)	14.0(0.55)
6	1/8	-AF-MT6-RT2	33.0(1.30)	10.4(0.41)	4.1(0.16)	14.0(0.55)
8	1/4	-AF-MT8-RT4	37.6(1.48)	15.0(0.59)	5.6(0.22)	19.0(0.75)
10	1/4	-AF-MT10-RT4	38.1(1.50)	15.0(0.59)	7.1(0.28)	19.0(0.75)
10	3/8	-AF-MT10-RT6	36.5(1.44)	15.0(0.59)	7.1(0.28)	22.0(0.87)
10	1/2	-AF-MT10-RT8	41.3(1.63)	19.8(0.78)	7.1(0.28)	27.0(1.06)
12	1/4	-AF-MT12-RT4	43.7(1.72)	15.0(0.59)	8.8(0.35)	19.0(0.75)
12	3/8	-AF-MT12-RT6	43.7(1.72)	15.0(0.59)	8.8(0.35)	22.0(0.87)
12	1/2	-AF-MT12-RT8	46.8(1.84)	19.8(0.78)	8.8(0.35)	27.0(1.06)
16	1/2	-AF-MT16-RT8	48.4(1.91)	19.8(0.78)	12.0(0.47)	27.0(1.06)
18	3/4	-AF-MT18-RT12	52.4(2.06)	20.6(0.81)	14.0(0.55)	32.0(1.26)
20	3/4	-AF-MT20-RT12	52.4(2.06)	20.6(0.81)	15.5(0.61)	32.0(1.26)
25	1	-AF-MT25-RT16	66.7(2.63)	25.4(1.00)	19.8(0.78)	41.0(1.61)

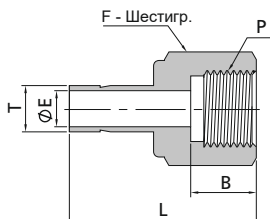

Метрическая трубка			Цилиндрическая резьба ISO (RP)			
D нар. трубки T (мм)	Размер P-RP	Артикул	Размеры, мм (дюймы)			
			L	B	E	F
6	1/8	-AF-MT6-RP2	32.0(1.26)	10.2(0.40)	4.1(0.16)	14.0(0.55)
6	1/4	-AF-MT6-RP4	37.8(1.49)	15.2(0.60)	4.1(0.16)	19.0(0.75)
12	1/2	-AF-MT12-RP8	49.8(1.96)	18.8(0.74)	8.8(0.35)	27.0(1.06)

Переходник с внутренней резьбой

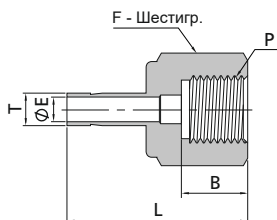

D нар. трубки T (мм)	Размер P-RG	Артикул	Цилиндрическая резьба ISO (RG)			
			L	B	E	F
3	1/8	-AF-MT3-RG2	28.6(1.13)	9.8(0.39)	1.9(0.07)	14.0(0.55)
3	1/4	-AF-MT3-RG4	33.5(1.32)	12.9(0.50)	1.9(0.07)	19.0(0.75)
4	1/8	-AF-MT4-RG2	29.4(1.16)	9.8(0.39)	2.4(0.09)	14.0(0.55)
6	1/8	-AF-MT6-RG2	29.1(1.15)	9.8(0.39)	4.1(0.16)	14.0(0.55)
6	1/4	-AF-MT6-RG4	35.3(1.39)	12.9(0.50)	4.1(0.16)	19.0(0.75)
6	3/8	-AF-MT6-RG6	38.4(1.51)	14.2(0.56)	4.1(0.16)	24.0(0.94)
6	1/2	-AF-MT6-RG8	42.9(1.69)	18.8(0.74)	4.1(0.16)	27.0(1.06)
8	1/4	-AF-MT8-RG4	33.0(1.30)	12.9(0.50)	5.5(0.22)	19.0(0.75)
8	3/8	-AF-MT8-RG6	38.9(1.53)	14.2(0.56)	5.6(0.22)	24.0(0.94)
8	1/2	-AF-MT8-RG8	43.7(1.72)	18.8(0.74)	5.6(0.22)	27.0(1.06)
10	1/4	-AF-MT10-RG4	34.5(1.36)	12.9(0.50)	5.5(0.22)	19.0(0.75)
10	3/8	-AF-MT10-RG6	36.1(1.42)	14.2(0.56)	6.5(0.26)	24.0(0.94)
10	1/2	-AF-MT10-RG8	41.1(1.62)	18.8(0.74)	7.1(0.28)	27.0(1.06)
12	1/4	-AF-MT12-RG4	40.1(1.58)	12.9(0.50)	5.5(0.22)	19.0(0.75)
12	3/8	-AF-MT12-RG6	44.7(1.76)	14.2(0.56)	6.5(0.26)	24.0(0.94)
12	1/2	-AF-MT12-RG8	48.8(1.92)	18.8(0.74)	7.0(0.28)	27.0(1.06)
16	1/2	-AF-MT16-RG8	49.0(1.93)	18.8(0.74)	7.0(0.28)	27.0(1.06)
18	1/2	-AF-MT18-RG8	49.3(1.94)	18.8(0.74)	7.0(0.28)	27.0(1.06)

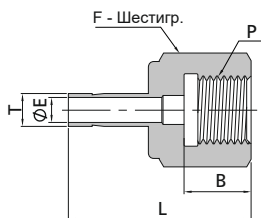

Переход к наружной резьбе в соответствии с японским стандартом для манометров

D нар. трубки T (мм)	Размер P-RJ	Артикул	Цилиндрическая резьба ISO (RJ)			
			L	B	E	F
6	1/4	-AF-MT6-RJ4	35.3(1.39)	12.9(0.50)	4.1(0.16)	19.0(0.75)
6	3/8	-AF-MT6-RJ6	38.6(1.52)	15.8(0.62)	4.1(0.16)	24.0(0.94)
6	1/2	-AF-MT6-RJ8	42.9(1.69)	18.8(0.74)	4.1(0.16)	27.0(1.06)
8	1/4	-AF-MT8-RJ4	33.0(1.30)	12.9(0.50)	5.5(0.22)	19.0(0.75)
8	3/8	-AF-MT8-RJ6	39.4(1.55)	15.8(0.62)	5.6(0.22)	24.0(0.94)
8	1/2	-AF-MT8-RJ8	43.7(1.72)	18.8(0.74)	5.6(0.22)	27.0(1.06)
10	1/4	-AF-MT10-RJ4	34.5(1.36)	12.9(0.50)	5.5(0.22)	19.0(0.75)
10	3/8	-AF-MT10-RJ6	36.1(1.42)	15.8(0.62)	6.5(0.26)	24.0(0.94)
10	1/2	-AF-MT10-RJ8	41.1(1.62)	18.8(0.74)	7.1(0.28)	27.0(1.06)
12	1/4	-AF-MT12-RJ4	40.1(1.58)	12.9(0.50)	5.5(0.22)	19.0(0.75)
12	3/8	-AF-MT12-RJ6	44.7(1.76)	15.8(0.62)	6.5(0.26)	24.0(0.94)
12	1/2	-AF-MT12-RJ8	48.8(1.92)	18.8(0.74)	7.0(0.28)	27.0(1.06)

Переходник приварной встык

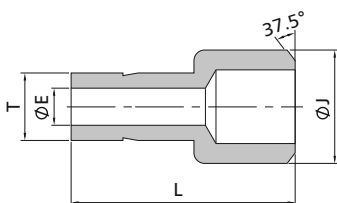

D нар. трубки T (дюймы)	Размер приварного патрубка	Артикул	Приварка толстостенной трубы встык		
			L	J	E
1/4	1/4	-AW-FT4-PB4	29.0(1.14)	13.7(0.54)	4.3(0.17)
3/8	1/2	-AW-FT6-PB8	37.1(1.46)	21.3(0.84)	6.9(0.27)
1/2	1/2	-AW-FT8-PB8	42.2(1.66)	21.3(0.84)	9.4(0.37)
1/2	3/4	-AW-FT8-PB12	42.7(1.68)	26.7(1.05)	9.4(0.37)
3/4	3/4	-AW-FT12-PB12	47.5(1.87)	26.7(1.05)	14.7(0.58)

Фланцевый адаптер

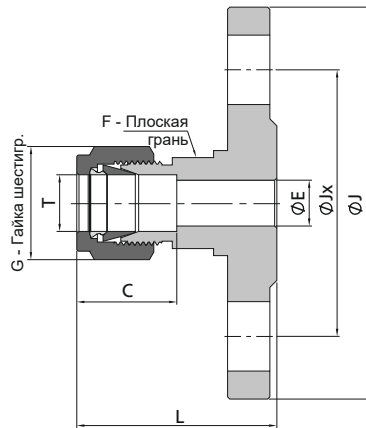

- ⊙ Полностью кованный корпус.
- ⊙ Фланцы ANSI соответствуют ANSI B16.5.
- ⊙ Фланцы DIN соответствуют DIN 2501/2526.
- ⊙ Фланцы GB соответствуют GB/T 9123.1.
- ⊙ Фланцы EN соответствуют EN 1092-1.
- ⊙ Фланцы JIS соответствуют JIS B 2220.

Фланцы ANSI

D нар. трубки T (дюймы)	Фланцы ANSI NPS	Класс	Артикул Тип уплотнительной поверхности - Raised Face (RF)	Размеры, мм (дюймы)						
				L	J	Jx	E	C	G	F
1/4	1/2	150	-FA-FL4-F8-150	40.9(1.61)	88.9(3.50)	60.5(2.38)	4.8(0.19)	15.2(0.60)	14.3(0.56)	20.6(0.81)
3/8	1/2	300	-FA-FL6-F8-300	45.5(1.79)	95.3(3.75)	66.5(2.62)	7.1(0.28)	16.8(0.66)	17.5(0.69)	20.6(0.81)
1/2	1/2	150	-FA-FL8-F8-150	45.2(1.78)	88.9(3.50)	60.5(2.38)	10.4(0.41)	22.9(0.90)	22.2(0.87)	20.6(0.81)
1/2	1	150	-FA-FL8-F16-150	48.3(1.90)	108.0(4.25)	79.2(3.12)	10.4(0.41)	22.9(0.90)	22.2(0.87)	20.6(0.81)
1/2	2	150	-FA-FL8-F32-150	53.1(2.09)	152.4(6.00)	121.0(4.76)	10.4(0.41)	22.9(0.90)	22.2(0.87)	20.6(0.81)
3/4	1	150	-FA-FL12-F16-150	50.3(1.98)	108.0(4.25)	79.2(3.12)	15.7(0.62)	24.4(0.96)	28.6(1.13)	31.8(1.25)
1	1	150	-FA-FL16-F16-150	60.5(2.38)	108.0(4.25)	79.2(3.12)	22.4(0.88)	31.2(1.23)	38.1(1.50)	34.9(1.37)

Фланцы DIN/GB, класс давления PN 40

D нар. трубки T (мм)	Фланцы ANSI размера DN	Артикул Тип уплотнительной поверхности - с выступом (B1)	Размеры, мм (дюймы)						
			L	J	Jx	E	C	G	F
6	25	-FA-ML6-F25-40B1	47.5(1.87)	115.0(4.53)	85.0(3.35)	4.8(0.19)	15.3(0.60)	14.0(0.55)	20.0(0.79)
12	15	-FA-ML12-F15-40B1	48.5(1.91)	95.0(3.74)	65.0(2.56)	9.5(0.37)	22.8(0.90)	22.0(0.87)	20.0(0.79)
12	25	-FA-ML12-F25-40B1	50.5(1.99)	115.0(4.53)	85.0(3.35)	9.5(0.37)	22.8(0.90)	22.0(0.87)	20.0(0.79)
12	50	-FA-ML12-F50-40B1	55.3(2.18)	165.0(6.50)	125.0(4.92)	9.5(0.37)	22.8(0.90)	22.0(0.87)	20.0(0.79)
18	15	-FA-ML18-F15-40B1	51.8(2.04)	95.0(3.74)	65.0(2.56)	15.1(0.59)	24.4(0.96)	30.0(1.18)	32.0(1.26)
18	25	-FA-ML18-F25-40B1	53.8(2.12)	115.0(4.53)	85.0(3.35)	15.1(0.59)	24.4(0.96)	30.0(1.18)	32.0(1.26)
25	25	-FA-ML25-F25-40B1	64.0(2.52)	115.0(4.53)	85.0(3.35)	21.8(0.86)	31.3(1.23)	38.0(1.50)	35.0(1.38)

Переходник фланцевый

Обжимные
фитинги

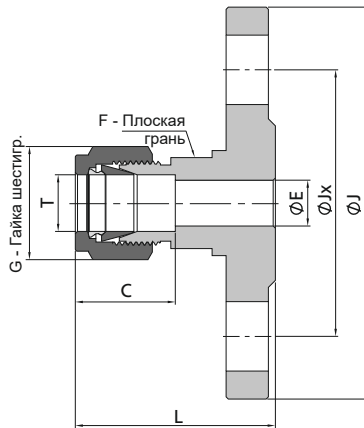

- ⊙ Полностью кованный корпус.
- ⊙ Фланцы ANSI соответствуют ANSI B16.5.
- ⊙ Фланцы DIN соответствуют DIN 2501/2526.
- ⊙ Фланцы GB соответствуют GB/T 9123.1.
- ⊙ Фланцы EN соответствуют EN 1092-1.
- ⊙ Фланцы JIS соответствуют JIS B 2220.

Фланцы EN, класс давления PN 40									
D нар. трубки T (мм)	Фланцы EN размер DN	Артикул Тип уплотнительной поверхности - с выступом (B1)	Размеры, мм (дюймы)						
			L	J	Jx	E	C	G	F
6	25	-FA-ML6-F25E-40B1	47.5(1.87)	115.0(4.53)	85.0(3.35)	4.8(0.19)	15.3(0.60)	14.0(0.55)	20.0(0.79)
12	15	-FA-ML12-F15E-40B1	48.5(1.91)	95.0(3.74)	65.0(2.56)	9.5(0.37)	22.8(0.90)	22.0(0.87)	20.0(0.79)
12	25	-FA-ML12-F25E-40B1	50.5(1.99)	115.0(4.53)	85.0(3.35)	9.5(0.37)	22.8(0.90)	22.0(0.87)	20.0(0.79)
12	50	-FA-ML12-F50E-40B1	55.3(2.18)	165.0(6.50)	125.0(4.92)	9.5(0.37)	22.8(0.90)	22.0(0.87)	20.0(0.79)
18	15	-FA-ML18-F15E-40B1	51.8(2.04)	95.0(3.74)	65.0(2.56)	15.1(0.59)	24.4(0.96)	30.0(1.18)	32.0(1.26)
18	25	-FA-ML18-F25E-40B1	53.8(2.12)	115.0(4.53)	85.0(3.35)	15.1(0.59)	24.4(0.96)	30.0(1.18)	32.0(1.26)
25	25	-FA-ML25-F25E-40B1	64.0(2.52)	115.0(4.53)	85.0(3.35)	21.8(0.86)	31.3(1.23)	38.0(1.50)	35.0(1.38)

Фланцы JIS, класс давления 10K									
D нар. трубки T	Фланцы JIS размер DN	Артикул Тип уплотнительной поверхности - Raised Face (RF)	Размеры, мм (дюймы)						
			L	J	Jx	E	C	G	F
1/4"	15	-FA-FL4-F15-10KRF	42.2(1.66)	95.0(3.74)	70.1(2.76)	4.8(0.19)	15.2(0.60)	14.3(0.56)	20.6(0.81)
3/8"	15	-FA-FL6-F15-10KRF	43.7(1.72)	95.0(3.74)	70.1(2.76)	7.1(0.28)	16.8(0.66)	17.5(0.69)	20.6(0.81)
1/2"	15	-FA-FL8-F15-10KRF	46.5(1.83)	95.0(3.74)	70.1(2.76)	10.4(0.41)	22.9(0.90)	22.2(0.87)	20.6(0.81)
3/4"	15	-FA-FL12-F15-10KRF	48.5(1.91)	95.0(3.74)	70.1(2.76)	15.7(0.62)	24.4(0.96)	28.6(1.13)	31.8(1.25)
1"	25	-FA-FL16-F25-10KRF	61.0(2.40)	125.0(4.92)	89.9(3.54)	22.4(0.88)	31.2(1.23)	38.1(1.50)	34.9(1.37)
12 мм	15	-FA-ML12-F15-10KRF	46.5(1.83)	95.0(3.74)	70.0(2.76)	9.5(0.37)	22.8(0.90)	22.0(0.87)	20.0(0.79)
18 мм	15	-FA-ML18-F15-10KRF	48.5(1.91)	95.0(3.74)	70.0(2.76)	15.1(0.59)	24.4(0.96)	30.0(1.18)	32.0(1.26)
25 мм	25	-FA-ML25-F25-10KRF	61.0(2.40)	125.0(4.92)	90.0(3.54)	21.8(0.86)	31.3(1.23)	38.0(1.50)	35.0(1.38)

Штуцер приварной

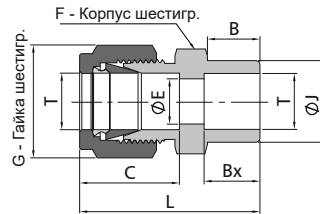

Дюймовая трубка		Приварка трубки внаруб							
D нар. трубки T (дюймы)	Артикул	Размеры, мм (дюймы)							
		L	C	G	F	B	E	Vx	J
1/8	-CW-FL2-TS2	29.0(1.14)	12.7(0.50)	11.1(0.44)	11.1(0.44)	8.6(0.34)	2.3(0.09)	2.5(0.10)	7.9(0.31)
3/16	-CW-FL3-TS3	29.7(1.17)	13.7(0.54)	12.7(0.50)	11.1(0.44)	9.5(0.37)	3.3(0.13)	4.8(0.19)	10.7(0.42)
1/4	-CW-FL4-TS4	33.5(1.32)	15.2(0.60)	14.3(0.56)	12.7(0.50)	10.4(0.41)	4.8(0.19)	7.1(0.28)	12.2(0.48)
3/8	-CW-FL6-TS6	37.6(1.48)	16.8(0.66)	17.5(0.69)	15.9(0.63)	11.9(0.47)	7.1(0.28)	7.9(0.31)	15.7(0.62)
1/2	-CW-FL8-TS8	41.1(1.62)	22.9(0.90)	22.2(0.87)	20.6(0.81)	11.9(0.47)	10.4(0.41)	12.7(0.50)	19.1(0.75)
5/8	-CW-FL10-TS10	41.9(1.65)	24.4(0.96)	25.4(1.00)	23.8(0.94)	11.9(0.47)	12.7(0.50)	10.4(0.41)	23.4(0.92)
3/4	-CW-FL12-TS12	43.4(1.71)	24.4(0.96)	28.6(1.13)	27.0(1.06)	11.9(0.47)	15.7(0.62)	11.1(0.44)	26.7(1.05)
1	-CW-FL16-TS16	52.6(2.07)	31.2(1.23)	38.1(1.50)	34.9(1.37)	14.2(0.56)	22.4(0.88)	15.7(0.62)	34.5(1.36)

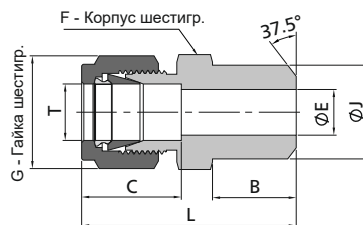

Дюймовая трубка			Приварка толстостенной трубы встык						
D нар. трубки T (дюймы)	Размер приварного патрубка	Артикул	Размеры, мм (дюймы)						
			L	C	G	F	E	B	J
1/8	1/8	-CW-FL2-PB2	30.5(1.20)	12.7(0.50)	11.1(0.44)	11.1(0.44)	2.3(0.09)	9.7(0.38)	10.3(0.41)
3/16	1/8	-CW-FL3-PB2	31.2(1.23)	13.7(0.54)	12.7(0.50)	11.1(0.44)	3.0(0.12)	9.7(0.38)	10.3(0.41)
1/4	1/8	-CW-FL4-PB2	32.8(1.29)	15.2(0.60)	14.3(0.56)	12.7(0.50)	4.8(0.19)	9.7(0.38)	10.3(0.41)
1/4	1/4	-CW-FL4-PB4	37.8(1.49)	15.2(0.60)	14.3(0.56)	14.3(0.56)	4.8(0.19)	14.2(0.56)	13.7(0.54)
5/16	1/8	-CW-FL5-PB2	34.0(1.34)	16.3(0.64)	15.9(0.63)	14.3(0.56)	5.3(0.21)	9.7(0.38)	10.3(0.41)
5/16	1/4	-CW-FL5-PB4	38.6(1.52)	16.3(0.64)	15.9(0.63)	14.3(0.56)	6.4(0.25)	14.2(0.56)	13.7(0.54)
3/8	1/4	-CW-FL6-PB4	39.9(1.57)	16.8(0.66)	17.5(0.69)	15.9(0.63)	7.1(0.28)	14.2(0.56)	13.7(0.54)
3/8	3/8	-CW-FL6-PB6	39.9(1.57)	16.8(0.66)	17.5(0.69)	17.5(0.69)	7.1(0.28)	14.2(0.56)	17.1(0.67)
3/8	1/2	-CW-FL6-PB8	46.2(1.82)	16.8(0.66)	17.5(0.69)	22.2(0.87)	7.1(0.28)	19.1(0.75)	21.3(0.84)
3/8	3/4	-CW-FL6-PB12	47.8(1.88)	16.8(0.66)	17.5(0.69)	27.0(1.06)	7.1(0.28)	19.1(0.75)	26.7(1.05)
1/2	3/8	-CW-FL8-PB6	43.4(1.71)	22.9(0.90)	22.2(0.87)	20.6(0.81)	10.4(0.41)	14.2(0.56)	17.1(0.67)
1/2	1/2	-CW-FL8-PB8	49.0(1.93)	22.9(0.90)	22.2(0.87)	22.2(0.87)	10.4(0.41)	19.1(0.75)	21.3(0.84)
1/2	3/4	-CW-FL8-PB12	50.5(1.99)	22.9(0.90)	22.2(0.87)	27.0(1.06)	10.4(0.41)	19.1(0.75)	26.7(1.05)
5/8	1/2	-CW-FL10-PB8	49.0(1.93)	24.4(0.96)	25.4(1.00)	23.8(0.94)	12.7(0.50)	19.1(0.75)	21.3(0.84)
3/4	1/2	-CW-FL12-PB8	50.5(1.99)	24.4(0.96)	28.6(1.13)	27.0(1.06)	14.0(0.55)	19.1(0.75)	21.3(0.84)
3/4	3/4	-CW-FL12-PB12	50.5(1.99)	24.4(0.96)	28.6(1.13)	27.0(1.06)	15.7(0.62)	19.1(0.75)	26.7(1.05)
1	1	-CW-FL16-PB16	62.2(2.45)	31.2(1.23)	38.1(1.50)	34.9(1.37)	22.4(0.88)	23.9(0.94)	33.4(1.31)
1 1/4	1 1/4	-CW-FL20-PB20	77.2(3.04)	41.1(1.62)	47.6(1.87)	44.5(1.75)	27.7(1.09)	23.9(0.94)	42.2(1.66)
1 1/2	1 1/2	-CW-FL24-PB24	88.9(3.50)	50.0(1.97)	57.2(2.25)	54.0(2.13)	34.0(1.34)	26.2(1.03)	48.3(1.90)

Штуцер приварной

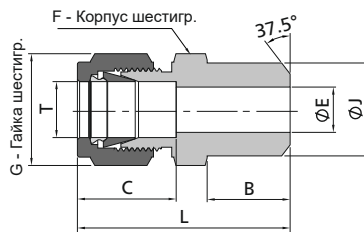

Метрическая трубка			Приварка толстостенной трубы встык						
D нар. трубки T (мм)	Размер приварного патрубка	Артикул	Размеры, мм (дюймы)						
			L	C	G	F	E	B	J
3	1/8	-CW-ML3-PB2	30.5(1.20)	12.9(0.51)	12.0(0.47)	12.0(0.47)	2.4(0.09)	9.7(0.38)	10.3(0.41)
4	1/8	-CW-ML4-PB2	31.5(1.24)	13.7(0.54)	12.0(0.47)	12.0(0.47)	2.4(0.09)	9.7(0.38)	10.3(0.41)
6	1/8	-CW-ML6-PB2	32.8(1.29)	15.3(0.60)	14.0(0.55)	14.0(0.55)	4.8(0.19)	9.7(0.38)	10.3(0.41)
6	1/4	-CW-ML6-PB4	37.9(1.49)	15.3(0.60)	14.0(0.55)	14.0(0.55)	4.8(0.19)	14.2(0.56)	13.7(0.54)
8	1/8	-CW-ML8-PB2	34.2(1.35)	16.2(0.64)	16.0(0.63)	15.0(0.59)	5.4(0.21)	9.7(0.38)	10.3(0.41)
8	1/4	-CW-ML8-PB4	38.7(1.52)	16.2(0.64)	16.0(0.63)	15.0(0.59)	6.4(0.25)	14.2(0.56)	13.7(0.54)
8	1/2	-CW-ML8-PB8	45.6(1.80)	16.2(0.64)	16.0(0.63)	22.0(0.87)	6.4(0.25)	19.1(0.75)	21.3(0.84)
10	1/4	-CW-ML10-PB4	40.9(1.60)	17.2(0.70)	19.0(0.75)	18.0(0.71)	7.5(0.30)	14.2(0.56)	13.7(0.54)
10	3/8	-CW-ML10-PB6	40.9(1.60)	17.2(0.70)	19.0(0.75)	18.0(0.71)	7.9(0.31)	14.2(0.56)	17.1(0.67)
10	1/2	-CW-ML10-PB8	46.5(1.80)	17.2(0.70)	19.0(0.75)	22.0(0.87)	7.9(0.31)	19.1(0.75)	21.3(0.84)
12	1/4	-CW-ML12-PB4	43.4(1.70)	22.8(0.90)	22.0(0.87)	22.0(0.87)	7.5(0.30)	14.2(0.56)	13.7(0.54)
12	3/8	-CW-ML12-PB6	43.4(1.70)	22.8(0.90)	22.0(0.87)	22.0(0.87)	9.5(0.37)	14.2(0.56)	17.1(0.67)
12	1/2	-CW-ML12-PB8	49.0(1.90)	22.8(0.90)	22.0(0.87)	22.0(0.87)	9.5(0.37)	19.1(0.75)	21.3(0.84)
14	3/8	-CW-ML14-PB6	44.1(1.70)	24.4(0.96)	25.0(0.98)	24.0(0.94)	10.7(0.42)	14.2(0.56)	17.1(0.67)
15	1/2	-CW-ML15-PB8	49.0(1.90)	24.4(0.96)	25.0(0.98)	24.0(0.94)	11.9(0.47)	19.1(0.75)	21.3(0.84)
16	1/2	-CW-ML16-PB8	49.0(1.90)	24.4(0.96)	25.0(0.98)	24.0(0.94)	12.7(0.50)	19.1(0.75)	21.3(0.84)
18	1/2	-CW-ML18-PB8	50.5(2.00)	24.4(0.96)	30.0(1.18)	27.0(1.06)	13.9(0.55)	19.1(0.75)	21.3(0.84)
30	1 1/4	-CW-ML30-PB20	77.2(3.00)	39.6(1.60)	50.0(1.97)	46.0(1.81)	26.2(1.03)	23.9(0.94)	42.2(1.66)
32	1 1/4	-CW-ML32-PB20	79.6(3.10)	42.0(1.70)	50.0(1.97)	46.0(1.81)	28.6(1.13)	23.9(0.94)	42.2(1.66)
38	1 1/2	-CW-ML38-PB24	91.6(3.60)	49.4(1.90)	60.0(2.36)	55.0(2.17)	33.7(1.33)	26.2(1.03)	48.3(1.90)

Угольник приварной 90°

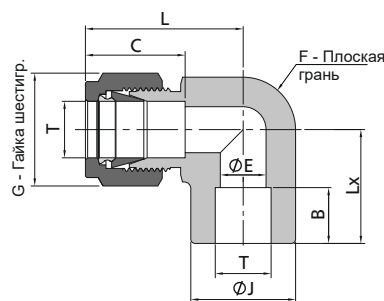

Дюймовая трубка		Приварка трубки внахлест							
D нар. трубки T (дюймы)	Артикул	Размеры, мм (дюймы)							
		L	C	G	F	B	E	Lx	J
1/8	-LW-FL2-TS2	16.8(0.66)	12.7(0.50)	11.1(0.44)	9.5(0.37)	2.5(0.10)	2.3(0.09)	16.0(0.63)	9.7(0.38)
3/16	-LW-FL3-TS3	18.3(0.72)	13.7(0.54)	12.7(0.50)	11.1(0.44)	4.8(0.19)	3.3(0.13)	17.5(0.69)	11.2(0.44)
1/4	-LW-FL4-TS4	26.9(1.06)	15.2(0.60)	14.3(0.56)	12.7(0.50)	7.1(0.28)	4.8(0.19)	19.6(0.77)	12.7(0.50)
3/8	-LW-FL6-TS6	30.5(1.20)	16.8(0.66)	17.5(0.69)	15.9(0.63)	7.9(0.31)	7.1(0.28)	23.1(0.91)	15.7(0.62)
1/2	-LW-FL8-TS8	36.1(1.42)	22.9(0.90)	22.2(0.87)	20.6(0.81)	9.7(0.38)	10.4(0.41)	25.9(1.02)	20.6(0.81)
5/8	-LW-FL10-TS10	29.5(1.16)	24.4(0.96)	25.4(1.00)	27.0(1.06)	10.4(0.41)	12.7(0.50)	29.5(1.16)	23.9(0.94)
3/4	-LW-FL12-TS12	39.9(1.57)	24.4(0.96)	28.6(1.13)	27.0(1.06)	11.2(0.44)	15.7(0.62)	29.7(1.17)	26.9(1.06)
1	-LW-FL16-TS16	49.0(1.93)	31.2(1.23)	38.1(1.50)	34.9(1.37)	15.7(0.62)	22.4(0.88)	36.8(1.45)	35.1(1.38)

Угольник приварной 90°

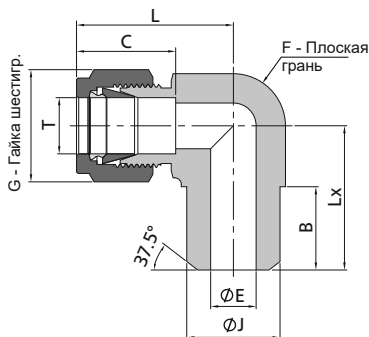

Дюймовая трубка			Приварка толстостенной трубы встык							
D нар. трубки T (дюймы)	Размер приварного патрубка	Артикул	Размеры, мм (дюймы)							
			L	C	G	F	B	E	Lx	J
1/8	1/8	-LW-FL2-PB2	23.4(0.92)	12.7(0.50)	11.1(0.44)	11.1(0.44)	9.7(0.38)	2.3(0.09)	18.3(0.72)	10.3(0.41)
3/16	1/8	-LW-FL3-PB2	25.7(1.01)	13.7(0.54)	12.7(0.50)	12.7(0.50)	9.7(0.38)	3.0(0.12)	18.8(0.74)	10.3(0.41)
1/4	1/8	-LW-FL4-PB2	26.9(1.06)	15.2(0.60)	14.3(0.56)	12.7(0.50)	9.7(0.38)	4.8(0.19)	18.8(0.74)	10.3(0.41)
1/4	1/4	-LW-FL4-PB4	26.9(1.06)	15.2(0.60)	14.3(0.56)	12.7(0.50)	14.2(0.56)	4.8(0.19)	23.4(0.92)	13.7(0.54)
3/8	1/4	-LW-FL6-PB4	30.5(1.20)	16.8(0.66)	17.5(0.69)	15.9(0.63)	14.2(0.56)	7.1(0.28)	25.4(1.00)	13.7(0.54)
1/2	3/8	-LW-FL8-PB6	34.8(1.37)	22.9(0.90)	22.2(0.87)	20.6(0.81)	14.2(0.56)	10.4(0.41)	28.8(1.13)	17.1(0.67)
1/2	1/2	-LW-FL8-PB8	36.1(1.42)	22.9(0.90)	22.2(0.87)	20.6(0.81)	19.1(0.75)	10.4(0.41)	33.0(1.30)	21.3(0.84)
5/8	1/2	-LW-FL10-PB8	36.3(1.43)	24.4(0.96)	25.4(1.00)	23.8(0.94)	19.1(0.75)	12.7(0.50)	35.1(1.38)	21.3(0.84)
3/4	3/4	-LW-FL12-PB12	39.9(1.57)	24.4(0.96)	28.6(1.13)	27.0(1.06)	19.1(0.75)	15.7(0.62)	36.8(1.45)	26.7(1.05)
1	3/4	-LW-FL16-PB12	49.3(1.94)	31.2(1.23)	38.1(1.50)	34.9(1.37)	19.1(0.75)	18.8(0.74)	41.9(1.65)	26.7(1.05)
1	1	-LW-FL16-PB16	49.3(1.94)	31.2(1.23)	38.1(1.50)	34.9(1.37)	23.9(0.94)	22.4(0.88)	46.7(1.84)	33.4(1.31)

Штуцер приварной для автоматической сварки

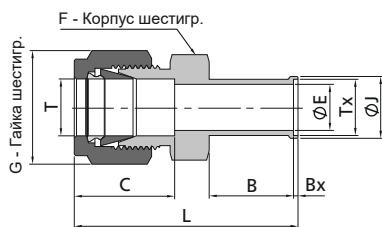

Дюймовая трубка			Приварка встык трубок с помощью автоматической сварки							
D нар. трубки T (дюймы)	D нар. трубки Tx (дюймы)	Артикул	Размеры, мм (дюймы)							
			L	C	G	F	B	E	Bx	J
1/4	1/4	-CW-FL4-TB4A	44.2(1.74)	15.2(0.60)	14.3(0.56)	12.7(0.50)	19.1(0.75)	4.5(0.18)	0.5(0.02)	7.4(0.29)
3/8	3/8	-CW-FL6-TB6A	46.7(1.84)	16.8(0.66)	17.5(0.69)	15.9(0.63)	19.1(0.75)	7.8(0.31)	0.8(0.03)	10.4(0.41)
1/2	1/2	-CW-FL8-TB8A	50.5(1.99)	22.9(0.90)	22.2(0.87)	20.6(0.81)	19.1(0.75)	10.4(0.41)	1.0(0.04)	14.0(0.55)

Фитинг калибровочный

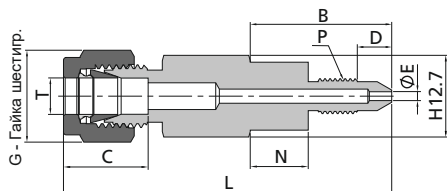

- ⊙ Фитинг калибровочный можно подсоединять непосредственно к выпускному порту датчика для упрощения процесса калибровки.
- ⊙ Доступны два типа для установки на выпускные отверстия датчиков.

D нар. трубки T (дюймы)	Размер резьбы P-SAE/MS	Артикул	Размеры, мм (дюймы)						
			L	B	C	D	E	G	N
1/4	1/4-28	-FC-FL4-1428	42.9(1.69)	19.8(0.78)	15.2(0.60)	10.9(0.43)	1.5(0.06)	14.3(0.56)	—
1/4	5/16-24	-FC-FL4-51624	58.9(2.32)	35.8(1.41)	15.2(0.60)	10.2(0.40)	1.5(0.06)	14.3(0.56)	10.4(0.41)

Фитинг с диэлектрической вставкой

Материалы

Компонент	Материал
Изолятор	Полиамидимид
Кольцо уплотнительное	Фторкаучук (FKM) твердость 70
Кольцо опорное	Чистый PTFE

Технические данные

- ⊙ Электрическое сопротивление изоляторов при 70 °F (20 °C): 10×10^6 Ом при 10 В.
- ⊙ Максимальное рабочее давление: 5000 фунтов на кв. дюйм изб. (344 бар) при 70 °F (21 °C).
- ⊙ Диапазон температур: от -4 °F (-20 °C) до 200 °F (93 °C).

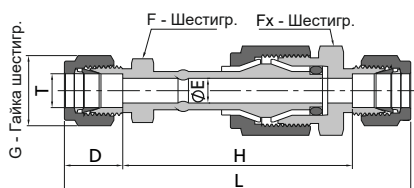

Дюймовая трубка

D нар. трубки T (дюймы)	Артикул	Размеры, мм (дюймы)						
		L	D	G	H	E	F	Fx
1/4	-DF-FL4	95.7(3.77)	15.2(0.60)	14.3(0.56)	65.3(2.57)	4.8(0.19)	12.7(0.50)	20.6(0.81)
3/8	-DF-FL6	99.6(3.92)	16.8(0.66)	17.5(0.69)	65.8(2.59)	7.1(0.28)	15.9(0.63)	20.6(0.81)
1/2	-DF-FL8	106.0(4.17)	22.9(0.90)	22.2(0.87)	60.2(2.37)	7.1(0.28)	20.6(0.81)	20.6(0.81)

Метрическая трубка

D нар. трубки T (мм)	Артикул	Размеры, мм (дюймы)						
		L	D	G	H	E	F	Fx
12	-DF-ML12	107.0(4.21)	22.8(0.90)	22.0(0.87)	61.7(2.43)	7.1(0.28)	22.0(0.87)	22.0(0.87)

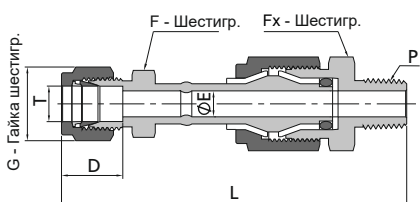

Дюймовая трубка

Резьба NPT

D нар. трубки T (дюймы)	Размер P-NPT	Артикул	Размеры, мм (дюймы)					
			L	D	G	E	F	Fx
3/8	1/4	-DF-FL6-NS4	94.7(3.73)	16.8(0.66)	17.5(0.69)	7.1(0.28)	15.9(0.63)	22.2(0.87)

Обжимные фитинги с прозрачной вставкой

Материалы

Компонент	Материал
Корпус	CF8M/A351
Прозрачная вставка	Боросиликатное стекло
Уплотнение	PTFE/D1710

Особенности

- Прозрачная вставка позволяет быстро и легко контролировать наличие потока среды в трубопроводных системах
- Полнопроходная конструкция предотвращает возникновение местных потерь давления

Технические параметры

- Максимальное рабочее давление: 38 бар (551 фунт на кв. дюйм) при 66°C (150°F)
24 бара (348 фунтов на кв. дюйм) при 200В°C (392°F)
- Диапазон рабочих температур: -от -40°C (-40°F) до 200°C (392°F)

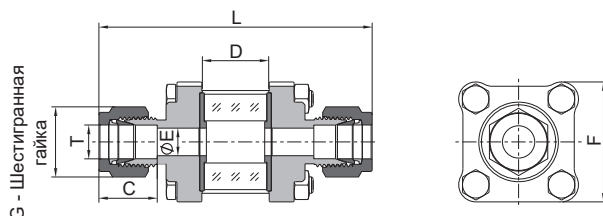

Дюймовая трубка		Размеры, мм (дюймы)					
D нар. трубки T (дюймы)	Артикул	L	C	G	E	D	F
1/4	-SGF-FL4	80.8 (3.18)	15.2 (0.60)	14.3 (0.56)	4.8 (0.19)	15.4 (0.61)	37.0 (1.34)
3/8	-SGF-FL6	80.8 (3.18)	16.8 (0.66)	17.5 (0.69)	7.1 (0.28)	15.4 (0.61)	37.0 (1.34)
1/2	-SGF-FL8	103.8 (4.09)	22.9 (0.90)	22.2 (0.87)	10.4 (0.41)	25.0 (0.98)	45.4 (1.79)
3/4	-SGF-FL12	103.8 (4.09)	24.4 (0.96)	28.6 (1.13)	15.7 (0.62)	25.0 (0.98)	45.4 (1.79)
1	-SGF-FL16	136.7 (5.38)	31.2 (1.23)	38.1 (1.50)	22.4 (0.88)	32.5 (1.28)	62.0 (2.44)

Метрическая трубка		Размеры, мм (дюймы)					
D нар. трубки T (мм)	Артикул	L	C	G	E	D	F
6	-SGF-ML6	80.8(3.18)	15.3(0.60)	14.0(0.55)	4.8(0.19)	15.4(0.61)	37.0(1.34)
8	-SGF-ML8	80.8(3.18)	16.2(0.64)	16.0(0.63)	6.4(0.25)	15.4(0.61)	37.0(1.34)
10	-SGF-ML10	80.8(3.18)	17.2(0.68)	19.0(0.75)	7.9(0.31)	15.4(0.61)	37.0(1.34)
12	-SGF-ML12	103.8(4.09)	22.8(0.90)	22.0(0.87)	9.5(0.37)	25.0(0.98)	45.4(1.79)
16	-SGF-ML16	103.8(4.09)	24.4(0.96)	25.0(0.98)	12.7(0.50)	25.0(0.98)	45.4(1.79)
25	-SGF-ML25	136.7(5.38)	31.3(1.23)	38.0(1.50)	21.8(0.86)	32.5(1.28)	62.0(2.44)

Примечание: Для получения информации о других размерах и типах торцевых присоединений, пожалуйста, обратитесь к FITOK или к нашим авторизованным дистрибьюторам.

Прокладка RS, RSD

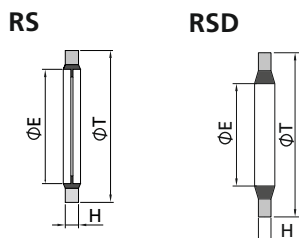

Прокладки RS и RSD применяются для уплотнения с наружной цилиндрической резьбой ISO. Прокладка состоит из внутреннего кольца из фтороуглерода FKM или буна-каучука (Buna), присоединенного к наружному кольцу из углеродистой или нержавеющей стали.

Размер цилиндрич. резьбы ISO	Артикул	Размеры, мм (дюймы)		
		T	E	H
1/8	-RS-2	16.0(0.63)	10.4(0.41)	2.0(0.08)
1/4	-RS-4	20.6(0.81)	13.7(0.54)	
3/8	-RS-6	23.9(0.94)	17.3(0.68)	
1/2	-RS-8	28.7(1.13)	21.6(0.85)	2.5(0.10)
3/4	-RS-12	35.1(1.38)	26.9(1.06)	
1	-RS-16	42.9(1.69)	33.8(1.33)	
1/8	-RSD-2	0.58(14.7)	0.47(12)	0.05(1.25)
1/4	-RSD-4	0.74(18.7)	0.62(15.75)	
3/8	-RSD-6	0.89(22.7)	0.76(19.25)	
1/2	-RSD-8	1.05(26.7)	0.93(23.55)	
3/4	-RSD-12	1.28(32.5)	1.15(29.2)	
1	-RSD-16	1.56(39.5)	1.42(36.1)	

Прокладка RS-M

Размер метрич. резьбы	Артикул	Размеры, мм (дюймы)		
		T	E	H
M8 x 1	-RS-M8	13.0(0.51)	8.7(0.34)	1.0(0.04)
M10 x 1	-RS-M10	16.0(0.63)	10.7(0.42)	1.5(0.06)
M12 x 1.5	-RS-M12	18.0(0.63)	12.7(0.42)	
M14 x 1.5	-RS-M14	22.0(0.71)	14.7(0.50)	
M16 x 1.5	-RS-M16	24.0(0.87)	16.7(0.66)	
M18 x 1.5	-RS-M18	26.0(0.94)	18.7(0.74)	
M20 x 1.5	-RS-M20	28.0(1.02)	20.7(0.81)	
M22 x 1.5	-RS-M22	30.0(1.10)	22.7(0.89)	2.0(0.08)
M24 x 1.5	-RS-M24	32.0(1.20)	24.7(1.00)	
M27 x 2	-RS-M27	36.0(1.30)	27.2(1.10)	
M30 x 2	-RS-M30	39.0(1.40)	30.7(1.20)	
M33 x 2	-RS-M33	42.0(1.50)	33.7(1.30)	2.5(0.10)
M36 x 2	-RS-M36	48.0(1.70)	37.0(1.50)	
M39 x 2	-RS-M39	51.0(1.90)	40.0(1.60)	
M42 x 2	-RS-M42	53.0(2.00)	42.7(1.70)	
M45 x 2	-RS-M45	57.0(2.10)	46.0(1.80)	3.0(0.12)
M48 x 2	-RS-M48	59.0(2.20)	48.7(1.90)	

Информация для заказа

Добавьте обозначение материала в виде префикса к артикулу из таблицы для получения полного артикула.

Кольцо		Обозначение
Наружное	Внутреннее	
Нержавеющая сталь	FKM	SSF
Углеродистая сталь	FKM	CSF
	Buna-N	CSB

Пример:

Прокладка RS с внутренним кольцом из буна-каучука, присоединенного к наружному кольцу из углеродистой стали, обеспечивает уплотнение с наружной резьбой 1/8 ISO, полный артикул – CSB-RS-2.

Прокладка RS может использоваться только с фитингом RS.

Прокладка RP

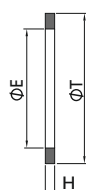

Прокладка RP применяется для уплотнения с наружной цилиндрической резьбой ISO. Прокладка RP может использоваться с фитингом RS.

Размер цилиндрич. резьбы ISO	Артикул	Размеры, мм (дюймы)		
		T	E	H
1/8	-RP-2	15.0(0.59)	9.9(0.39)	1.0(0.04)
1/4	-RP-4	19.1(0.75)	13.2(0.52)	1.5(0.06)
3/8	-RP-6	23.1(0.91)	16.8(0.66)	
1/2	-RP-8	26.9(1.06)	21.1(0.83)	
3/4	-RP-12	33.0(1.30)	26.7(1.05)	2.0(0.08)
1	-RP-16	40.1(1.58)	33.2(1.31)	

Прокладка RP-M

Размер метрич. резьбы	Артикул	Размеры, мм (дюймы)		
		T	E	H
M8 x 1	-RP-M8	13.2(0.52)	8.2(0.32)	1.5(0.06)
M10 x 1	-RP-M10	15.2(0.60)	10.2(0.40)	
M12 x 1.5	-RP-M12	18.2(0.60)	12.2(0.40)	
M14 x 1.5	-RP-M14	20.2(0.72)	14.2(0.48)	2.0(0.08)
M16 x 1.5	-RP-M16	22.2(0.80)	16.2(0.64)	
M18 x 1.5	-RP-M18	24.2(0.87)	18.2(0.72)	
M20 x 1.5	-RP-M20	26.2(0.95)	20.2(0.80)	
M22 x 1.5	-RP-M22	28.2(1.03)	22.2(0.87)	
M24 x 1.5	-RP-M24	30.2(1.10)	24.2(1.00)	
M27 x 2	-RP-M27	33.3(1.20)	27.2(1.10)	2.5(0.10)
M30 x 2	-RP-M30	37.3(1.30)	30.2(1.20)	
M33 x 2	-RP-M33	40.3(1.50)	33.2(1.30)	
M36 x 2	-RP-M36	43.3(1.60)	36.2(1.40)	
M39 x 2	-RP-M39	47.3(1.70)	39.2(1.50)	
M42 x 2	-RP-M42	50.3(1.90)	42.2(1.70)	
M45 x 2	-RP-M45	53.3(2.00)	45.2(1.80)	
M48 x 2	-RP-M48	56.3(2.10)	48.2(1.90)	

Прокладка RG

Прокладка RG применяется для уплотнения на манометрах с наружной цилиндрической резьбой ISO.

Размер цилиндрич. резьбы ISO	Артикул	Размеры, мм (дюймы)		
		T	E	H
1/4	-RG-4	10.7(0.42)	7.6(0.30)	1.8(0.07)
3/8	-RG-6	14.2(0.56)	8.6(0.34)	2.3(0.09)
1/2	-RG-8	17.8(0.70)	9.1(0.36)	2.5(0.10)

Прокладка RG-M

Размер цилиндрич. резьбы ISO	Артикул	Размеры, мм (дюймы)		
		T	E	H
M10 x 1	-RG-M10	8.3(0.33)	3.3(0.13)	2.0(0.08)
M12 x 1.5	-RG-M12	9.7(0.38)	5.4(0.21)	
M14 x 1.5	-RG-M14	11.7(0.38)	6.4(0.21)	
M16 x 1.5	-RG-M16	13.7(0.46)	8.4(0.25)	
M18 x 1.5	-RG-M18	15.7(0.54)	10.0(0.39)	
M20 x 1.5	-RG-M20	17.6(0.62)	11.4(0.45)	
M22 x 1.5	-RG-M22	19.6(0.69)	13.4(0.53)	
M24 x 1.5	-RG-M24	21.6(0.77)	14.8(0.58)	2.5(0.10)
M27 x 2	-RG-M27	24.0(0.90)	13.9(0.50)	
M30 x 2	-RG-M30	27.0(0.90)	19.5(0.80)	
M33 x 2	-RG-M33	30.0(1.10)	21.5(0.80)	
M36 x 2	-RG-M36	33.0(1.20)	23.5(0.90)	
M39 x 2	-RG-M39	36.0(1.30)	24.5(1.00)	
M42 x 2	-RG-M42	38.9(1.40)	29.5(1.20)	
M45 x 2	-RG-M45	41.9(1.50)	30.0(1.20)	
M48 x 2	-RG-M48	44.9(1.60)	32.5(1.30)	

Прокладка RJ

Прокладка RJ применяется для уплотнения на японских манометрах с наружной цилиндрической резьбой ISO.

Размер цилиндрич. резьбы ISO	Артикул	Размеры, мм (дюймы)		
		T	E	H
1/4	-RJ-4	10.9(0.43)	5.6(0.22)	1.0(0.04)
3/8	-RJ-6	13.9(0.55)	5.6(0.22)	1.0(0.04)
1/2	-RJ-8	17.8(0.70)	5.6(0.22)	1.0(0.04)

Информация для заказа

Добавьте обозначение материала в виде префикса к артикулу из таблицы для получения полного артикула.

Материал	Обозначение
Медь	CU
Нержавеющая сталь 316L	6L
Вулканизированная фибра	QB
PTFE	T

Вулканизированную фибру и PTFE нельзя использовать для прокладки RP.

Пример:

CU-RP-2, 6L-RG-6, QB-RG-M20, T-RJ-8.

Кольца уплотнительные



Кольца уплотнительные для фитингов с прямой резьбой SAE/MS

Размер резьбы SAE/MS	Артикул	Материал
5/16-24	VI9-902	Фторопластик (FKM) твердость 90
3/8-24	VI9-903	
7/16-20	VI9-904	
1/2-20	VI9-905	
9/16-18	VI9-906	
3/4-16	VI9-908	
7/8-14	VI9-910	
1 1/16-12	VI9-912	
1 3/16-12	VI9-914	
1 5/16-12	VI9-916	
1 5/8-12	VI9-920	
1 7/8-12	VI9-924	

Кольца уплотнительные для фитингов с трубной резьбой и кольцевым уплотнением

Размер резьбы NPT/ISO	Артикул	Материал
1/8	BN7-013	Твердость 70 (NBR)
1/4	BN7-113	
3/8	BN7-116	
1/2	BN7-118	

A-88 Обжимные фитинги серии 6D

Кольца уплотнительные для позиционируемых фитингов с цилиндрической резьбой ISO

Размер цилиндрич. резьбы ISO	Артикул	Материал
1/8	VI9-502	Фтороуглерод (FKM) твердость 90
1/4	VI9-111	
3/8	VI9-113	
1/2	VI9-508	
3/4	VI9-119	
1	VI9-217	

Кольца уплотнительные для фитингов с прямой резьбой и кольцевым уплотнением

Размер резьбы SAE/MS	Артикул	Материал
5/16-24	BN7-011	Твердость 70 (NBR)
3/8-24	BN7-012	
7/16-20	BN7-013	
1/2-20	BN7-112	
9/16-18	BN7-113	
3/4-16	BN7-116	
1 1/16-12	BN7-121	
1 5/16-12	BN7-125	

Уплотнительные кольца для фитингов с метрической резьбой

Размер резьбы SAE/MS	Артикул	Материал
M14 x 1.5	BN9-M14	Твердость 90 (NBR)
M20 x 1.5	BN9-M20	

Уплотнительная PTFE лента для резьбовых соединений

Характеристики

- ☉ Материал, соответствующий стандарту A-A-58092
- ☉ Рабочая температура до 232°C (450°F)



Информация для заказа

Размер уплотняемой резьбы	Размер ленты	Артикул
1/8", 1/4" и 3/8"	7×10000 мм	PTS-4
1/2" и больше	12×10000 мм	PTS-8

Примечания: Ленту следует использовать только с коническими резьбами. Не используйте с фитингами под развальцовку, с фитингами с конической уплотнительной поверхностью или с обжимными фитингами.

Обозначение артикула

SS - CM - ML12 - NS8 - □ - □ - □□

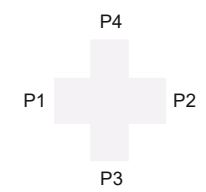
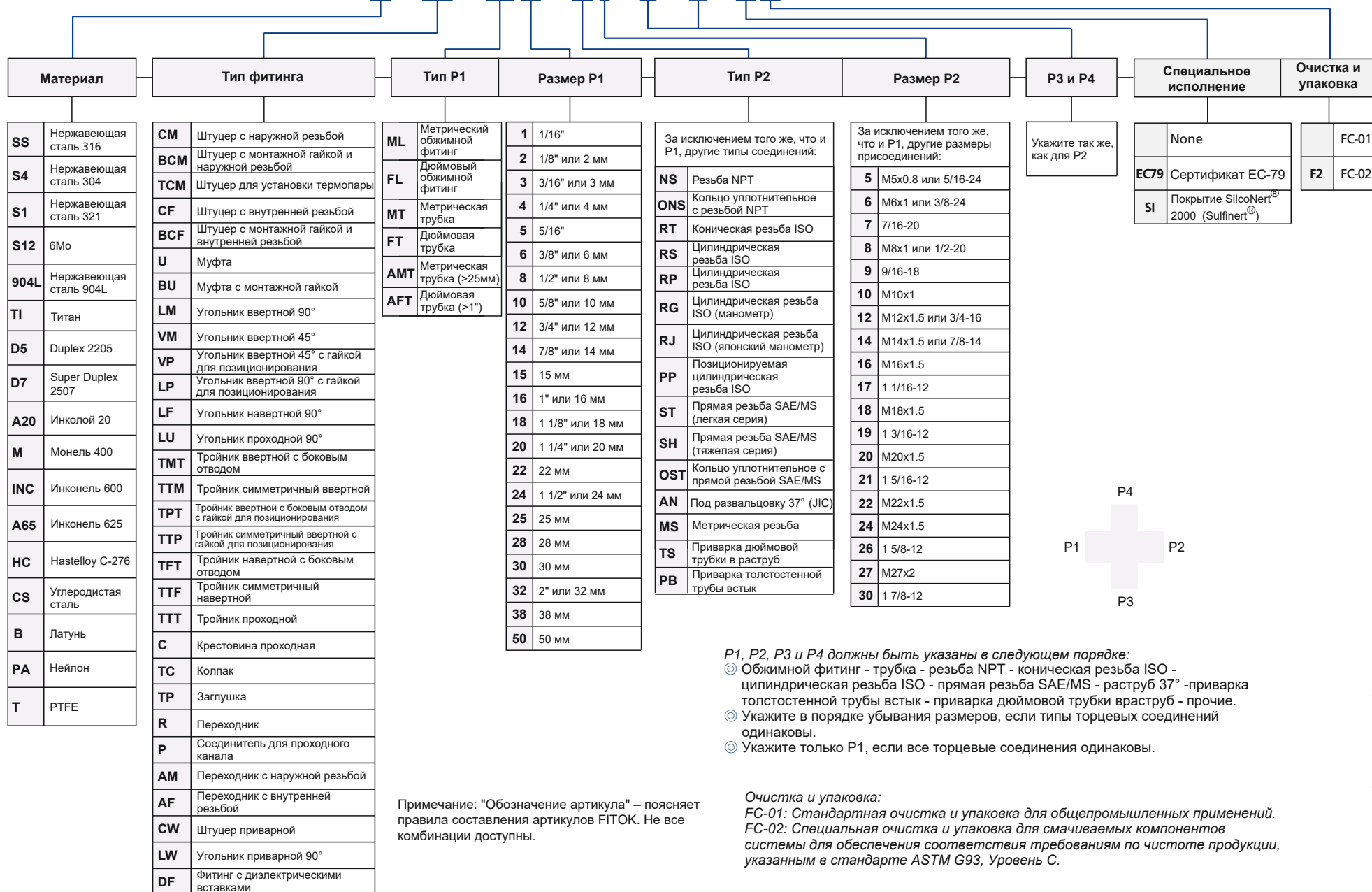

- P1, P2, P3 и P4 должны быть указаны в следующем порядке:
- Обжимной фитинг - трубка - резьба NPT - коническая резьба ISO - цилиндрическая резьба ISO - прямая резьба SAE/MS - раструб 37° - приварка толстостенной трубы встык - приварка дюймовой трубки в раструб - прочие.
 - Укажите в порядке убывания размеров, если типы торцевых соединений одинаковы.
 - Укажите только P1, если все торцевые соединения одинаковы.

Примечание: "Обозначение артикула" – поясняет правила составления артикулов FITOK. Не все комбинации доступны.

Очистка и упаковка:
 FC-01: Стандартная очистка и упаковка для общепромышленных применений.
 FC-02: Специальная очистка и упаковка для смачиваемых компонентов системы для обеспечения соответствия требованиям по чистоте продукции, указанным в стандарте ASTM G93, Уровень C.

info@fitok.com
www.fitok.com

FK-IC-GF-01-RU-230714